

APPLICATION NOTE

ANP116 | Gigabit Ethernet interface from an EMC perspective



Adrian Stirn

01. INTRODUCTION

In the design of an Ethernet interface, questions often arise concerning the shield connection of the cable and the front-end design, especially regarding the ground connections. Research on the Internet reveals various suggestions for the shield connection, where a 1 nF Y-capacitor is often suggested. However, the effect of the interface on performance and the EMC behavior are not described. This App Note takes a detailed look into the EMC properties of the Ethernet interface with various shield connections and configurations, and makes design recommendations based on hardware tests.

02. A BRIEF OVERVIEW OF THE TWO GB-ETHERNET DESIGNS USED

The electronics board used for the EMC analysis in this App Note has two interfaces, one USB Type-C™ (USB 3.1) - and one 1-Gigabit RJ45/Ethernet interface. The GB-Ethernet-USB adapter was developed on the basis of the EVB-LAN7800LC Evaluation Board from Microchip. The circuit is built on a 4-layer PCB and in the present design is supplied with voltage via the USB interface. The board is available in two different variants as described briefly below. These two designs are described briefly in Reference Design Note [RD016](#).

2.1 Discrete design of the Gigabit Ethernet board

The discrete design is briefly explained to provide an overview of the relevant circuit components in the Ethernet front end.

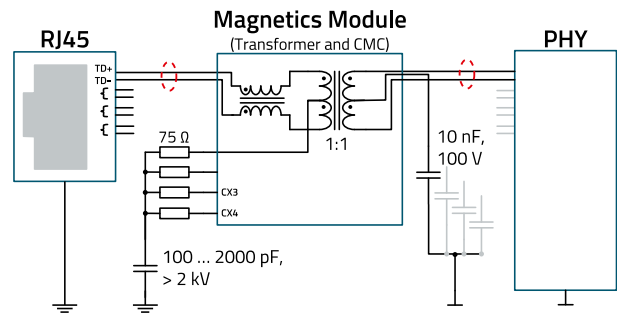

--- Impedance: 100 Ω differential, 50 Ω to GND

Figure 1: Schematic of the GB-Ethernet interface, one of the four channels is shown

The components from Figure 1 are necessary to operate the Ethernet interface between the RJ-45 connector and the physical layer (PHY in the OSI model). In the discrete design from Figure 2, the transformer and common mode choke are located in the [749020310](#) module, and the [modular jack](#) contains no other circuit components.

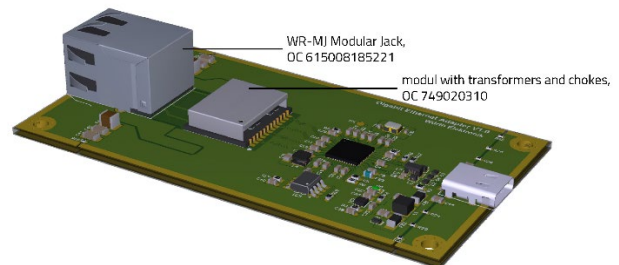

Figure 2: Graphical representation of the GB-Ethernet-USB adapter in the discrete V1.0 variant; the module with the transformers and common mode chokes is placed next to the RJ45 jack

2.2 Integrated design of the Gigabit Ethernet board

In the integrated design, the interface components from Figure 1 and the discrete design from Figure 2 are integrated in the [RJ45 jack](#). This saves space on the board, but limits the design flexibility of the front end.

APPLICATION NOTE

ANP116 | Gigabit Ethernet interface from an EMC perspective

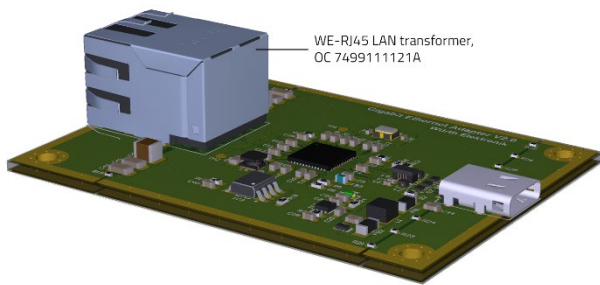

Figure 3: Graphical representation of the GB-Ethernet-USB adapter in the integrated V2.0 variant. The module shown in Figure 2 is integrated in the RJ45 jack

03. MEASUREMENT IN THE TIME DOMAIN

The Ethernet signals are measured in the time domain with an oscilloscope. The signals from the discrete board are first shown between PHY and the transformer. A low-capacitance differential probe with a bandwidth above 4 GHz is used for this purpose.

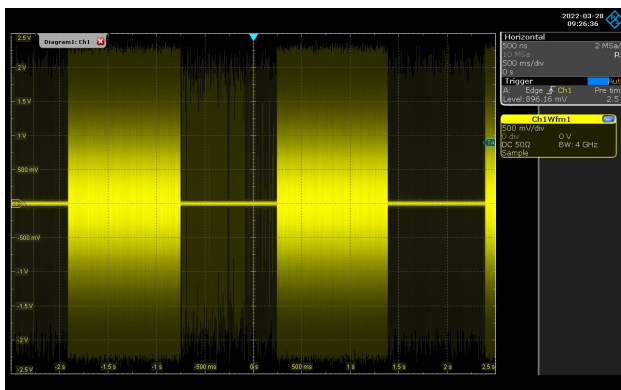

Figure 4: Measurement of the voltage between differential Ethernet signal pairs in the time domain with an oscilloscope and differential RF probe

Measurement of the test signal over several jumbo frames is shown in Figure 4. This results in data transmission of about one second with high signal intensity and lower intensity signal transmission over the same period. This results from the way the test signal is composed for the analysis of the EMC properties.

If the time span monitored in the test is reduced, the individually transmitted code states can be seen. However, it appears from Figure 5 that the PAM-5 code expected cannot be clearly identified. Moreover, the signal measured appears to have significantly more than 5 voltage levels. Clear identification of the line code is possible at this point for reasons of measurement technology. Correction methods are needed in PHY to enable perfect communication and signal detection.

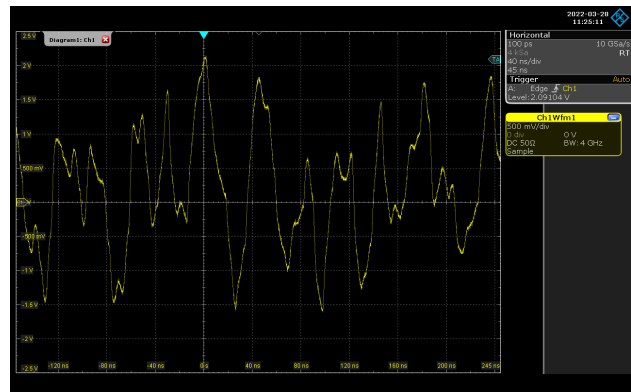

Figure 5: Ethernet signal between the transformer and PHY

Analysis of the line code is therefore only possible on the Ethernet cable in operation downstream of the transformer. A brief interpretation of the PAM-5 code in operation is shown in Figure 6 below. There are significantly fewer reflections and just 5 voltage levels.

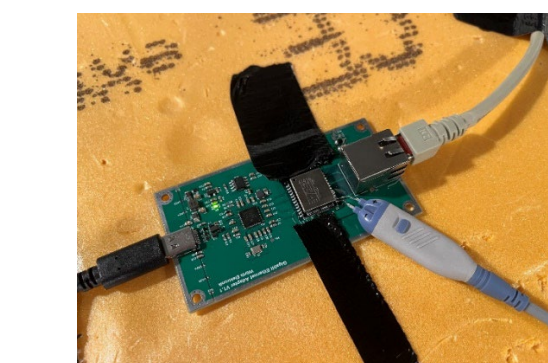
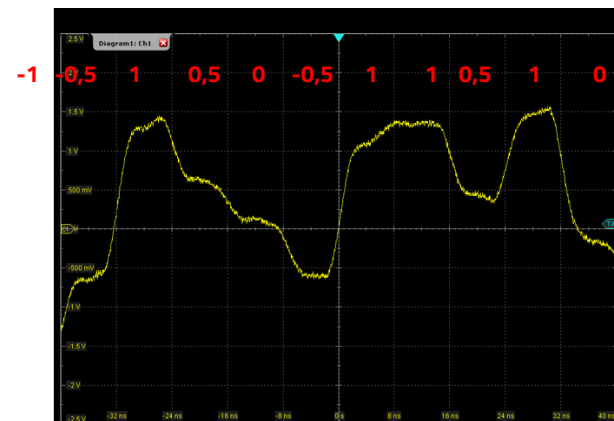

Figure 6: Top: Line code for the Ethernet signal between the transformer and RJ45 jack; Bottom: The measurement setup

Analysis of the rise time of the edge in the middle of the graph in Figure 6 reveals a 3 ns rise time from state -0.5 to state 1. Figure 7 shows the FFT of the Ethernet signal between the transformer and PHY. The outcome is a spectrum with signal components up to a frequency of 500 to 600 MHz. At higher frequencies, the signal is within the oscilloscope background noise. The signal drops significantly

APPLICATION NOTE

ANP116 | Gigabit Ethernet interface from an EMC perspective

in amplitude above 100 MHz, and the correlation between the rise time and drop in the frequency spectrum by 40 dB per decade above $f=1/(\pi \cdot tr)$ is shown.

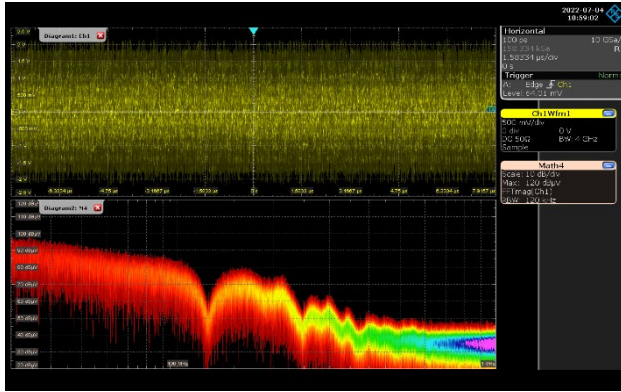

Figure 7: FFT analysis of the Ethernet signal between the transformer and PHY

04. EMC EVALUATION OF THE REFERENCE DESIGN

The reference design with regard to EMC properties is investigated as follows. The extremely extensive tests performed on the reference design are presented in part in condensed format. The main findings, application notes and design recommendations are summarized again in section 05.

4.1 Reduction of impact by using the necessary auxiliary equipment

The auxiliary equipment (AE) required for operating the test board may be disturbed during interference immunity testing or may falsify the results of interference emission

measurement. During EMC testing, some interference effects occurred which had to be eliminated for normatively meaningful measurement. These effects and the resulting solutions to eliminate them are described here. This subsection is intended to provide insight into strategies for optimizing experimental setups.

Interference emission testing in an initial setup

To obtain an initial overview of the EMC behavior, the test device was put into operation in an anechoic chamber and the radiated interference spectrum was measured. Figure 8 shows that the interference potential of the setup is high. Interference occurs which is not generated by the reference design itself.

Analysis of the first measurements showed that two interference sources were generated by the notebooks needed to conduct the test and radiated via the connected lines:

1. 120 MHz radiation due to a bad USB cable: The cable shield of pre-assembled USB cables is often not connected adequately to the shield connection of the plug. Depending on the quality of the cable shield and the type of shield connection, the interference emission of the experimental setup changes.
2. 4 MHz radiation caused by a notebook in the experimental setup: The interference seems to be generated by the battery charge controller, or another voltage controller.

In the environmental interference radiated by unsuitable USB cables or the interfering notebooks in the measurement setup, the lower interference of the reference design is

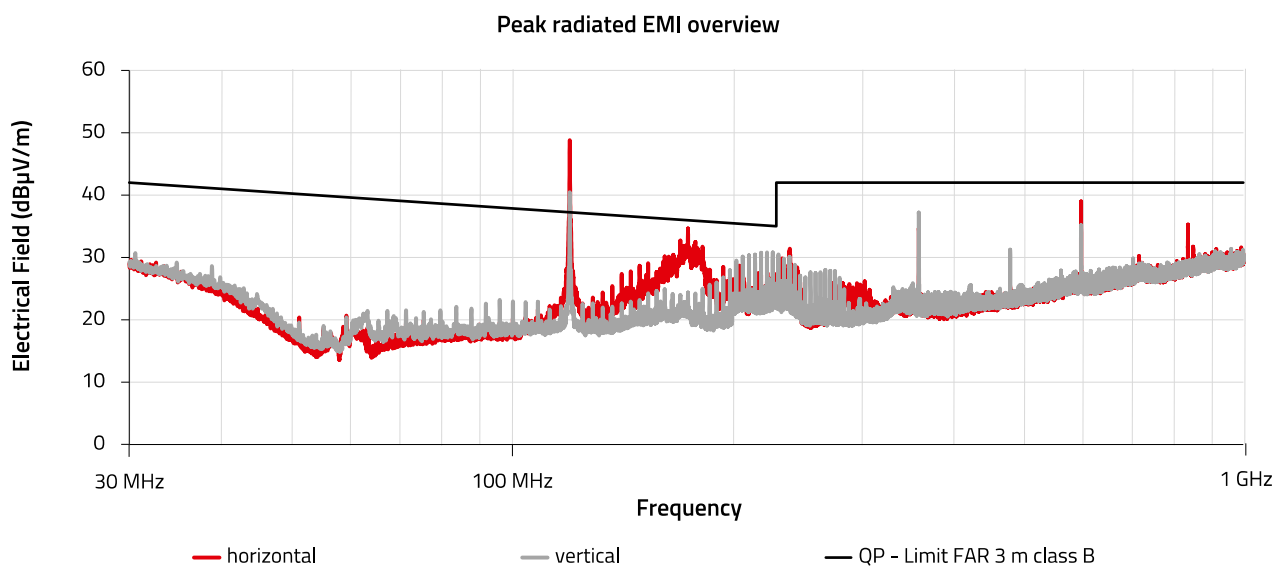

Figure 8: Radiated interference emission in a first quick scan

APPLICATION NOTE

ANP116 | Gigabit Ethernet interface from an EMC perspective

swamped. For this reason, the two points in the test setup identified above must be taken into account and the appropriate measures must be implemented to reduce extraneous interference.

Reducing the interference from the auxiliary equipment

Two notebooks are needed for operating and analyzing the interface data; these devices must be operated in a shielding box to shield their RF radiation. The shielding box from Figure 9 was built for this purpose.

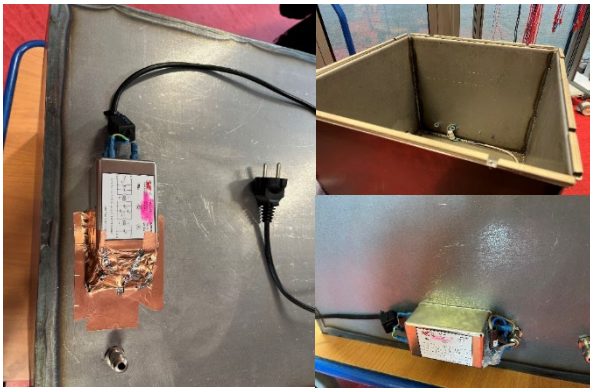

Figure 9: Shielding box to reduce the interference from the auxiliary equipment. The 230 V_{AC} supply is filtered into the box using a two-stage filter at the feedthrough. Shielded cables are connected to the package ground at the shielding feedthrough, and the cover is RF sealed to prevent electromagnetic radiation via openings.

The shielding effectiveness of the box was tested using a comb generator that emits a continuous line spectrum with frequency steps of 20 MHz. The shielding box reduces radiation from the interference generator by up to 70 dB and so is suitable for reducing the interference emission of the notebooks.

Furthermore, the notebooks in the shielding box are protected during interference immunity testing from influencing the test interference. The deficient connection of the USB cable shields to the USB plugs can be improved by using conductive [adhesive shielding tape \(WE-TS\)](#) (Figure 10).

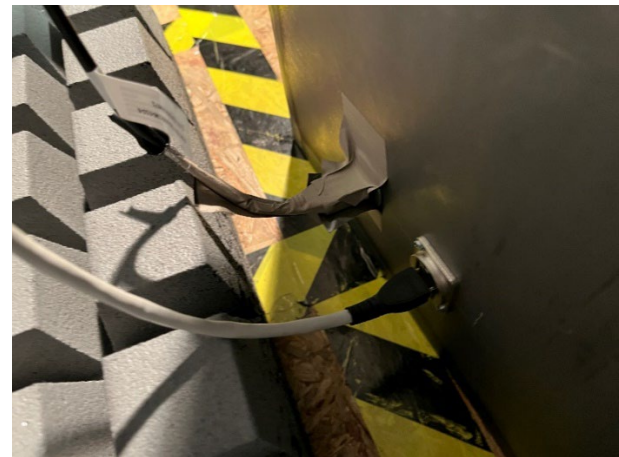
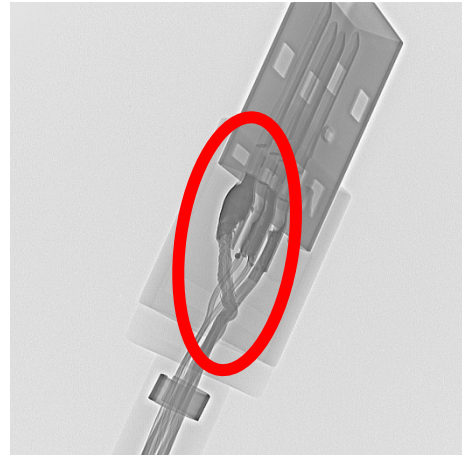

Figure 10: Top: X-ray image of a USB plug with deficient shield connection in "pigtail design". This type of connection reduces the effect of the shield braid; Bottom: Connection of the USB cable shield using shielding tape to improve the pigtail design in the USB plug

The measures significantly reduce extraneous interference. This allows an analysis and comparison of the EMC behavior between the different test devices to be performed.

4.2 Time of exposure to interference, error criteria and observation time for interference emission measurement

For performing the EMC tests reproducibly, the following must be defined:

1. the measuring time of the measuring receiver during interference emission
2. the exposure time of interference on the test device
3. the criteria for assessing the test device response during interference immunity testing

APPLICATION NOTE

ANP116 | Gigabit Ethernet interface from an EMC perspective

Time of exposure to interference and measurement time of the interference emission

To obtain meaningful results from the EMC tests, all operating states of a device must be analyzed. Figure 4 shows that the data transmission along the differential pairs is denser for one second and less dense for one second. Experiments have also shown that the interference is alternately higher and lower according to this periodicity, at a time interval of one second. In order to measure or test both states, all emission measurements and interference immunity tests were performed with a measurement or hold time of at least three seconds.

Criteria for evaluating interference immunity

As previously described, the test device was operated with two notebooks. One notebook controls the test device via USB interface and sends data to USB-PHY. These data are converted in the test device and sent out via the Ethernet interface. The second notebook is operated at the Ethernet interface of the test device, on which echo software sends the received data back to the test device. The data loss, error rate and data rate of the interface can thus be checked. This information can be read on the first notebook (USB interface of the test device) using control software.

Here it was noticed that the data rate depends significantly on the external influences of the auxiliary equipment. If a notebook goes into energy-saving mode, the processor clock rate is reduced by the Windows operating system and the interface speed is reduced accordingly. This speed reduction does not result from the influence interference, however, but is due to unplanned software changes. The data transfer also drops in part when stored data is shifted

in the operating system. These influences must be considered when evaluating interference immunity and, if necessary, influences from the operating system must be retested (see Figure 11).

Figure 11 shows monitoring of the error and data rate over the test period. Due to the correction and control bits used in the Ethernet protocol, approximately 850 MBps can be transmitted in an undisturbed state at maximum notebook performance. Table 1 below presents the evaluation criteria.

Measured variable	Performance criterion	Technical criterion
Data rate	A	In the 850 MBps range (Errors and fluctuations due to Windows operating system are not evaluated)
	B	Speed reduction below 800 MBps (Example in Figure 11)
	C	Connection failure
Error rate	A	0 %
	B	100 %
	C	Connection failure with required restart by user

Table 1: Evaluation and performance criteria of the test devices

The interference immunity tests revealed that the Ethernet interface either runs at full performance or under influence drops immediately to between 20 Mbps and 50 Mbps or the communication fails completely. The cause for this is the very effective error correction in the Ethernet protocol,

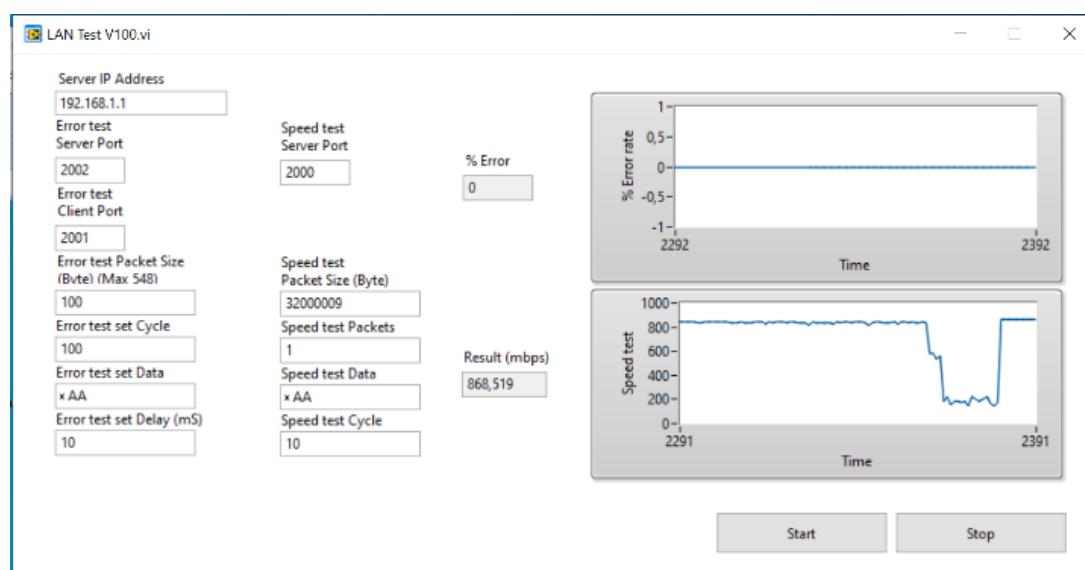

Figure 11: Test device monitoring with a notebook application. The speed drop is caused by an external disturbance.

APPLICATION NOTE

ANP116 | Gigabit Ethernet interface from an EMC perspective

which works in different software layers to detect and correct multiple errors up to almost 100%. A camera pointed at the notebook connected for monitoring allows the performance of the test device to be effectively monitored.

4.3 Test setup of the test device and auxiliary equipment for EMC analysis of the reference design

Based on the EMC requirements for the necessary auxiliary equipment as previously described, the test setup shown in Figure 12 consists of two notebooks in the shielding box, an Ethernet cable, a USB cable and the test device.

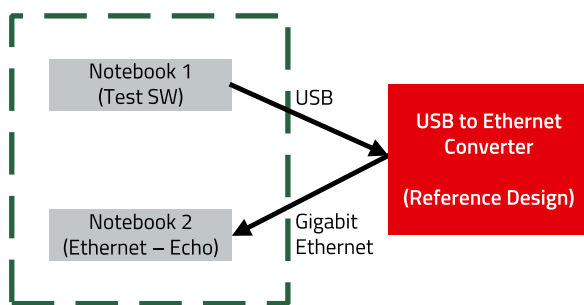

Figure 12: Test setup for analyzing the EMC behavior of the Ethernet reference design

The focus of the measurements and tests performed is on the Ethernet interface. The USB cable is therefore kept short in radiation testing and the Ethernet cable has a length of one meter on the test bench. The other EMC tests also focus on the Ethernet interface, so the USB interface was not tested. The test setup is shown in the application note [ANP105](#).

4.4 Influence of the cable type on interference emission

The influence of different cable types on the interference emission is considered at the beginning of the measurement series. This is particularly easy when testing interference emission, since the cable can simply be swapped between measurements and no special coupling networks adapted to the cable type are necessary.

When using shielded cables, it may be assumed that RF-compliant connection of the cable shield to the ground (GND plane) of the test device will lead to the lowest interference emission. To compare different cable types, a board with integrated interface setup (transformer and choke in the Ethernet jack) and direct shield connection (two-dimensional short circuit between the shield and ground plane) is selected.

The following cable types are compared with each other:

1. Shielded cable:
 - CAT8.1 S/FTP: Braided shielding as outer shield. The individual differential twisted pairs are shielded with foil.
 - CAT5E SF/UTP: Standard Ethernet cable for the commercial and office sector. Simple shielding of all cores with foil and light braiding. The differential twisted pairs are not shielded, so coupling between pairs is possible.
2. Unshielded cable:
 - CAT5E U/UTP: No shielding, the differential pairs are twisted pairs

The cable length used in the radiation testing is 3 to 5 m and may not be applicable for longer Ethernet cables as far as interference immunity is concerned, as the coupling between the individual pairs may be greater in this case.

Comparison of the radiated interference immunity

Interference immunity according to IEC 61000-4-3 is tested for the different cables. This shows that the two shielded cables in the frequency range 80 MHz to 3 GHz can be operated at least 20 V/m in "Performance Criterion A" during interference, and the unshielded cable at 10 V/m. The two shielded cables are thus comparable in performance for radiated interference immunity testing.

As the line lengths are only 3 to 5 m, the error rate may increase with longer cables due to stronger coupling.

Comparison of radiation

The following two figures show the interference radiation using different Ethernet cables.

APPLICATION NOTE

ANP116 | Gigabit Ethernet interface from an EMC perspective

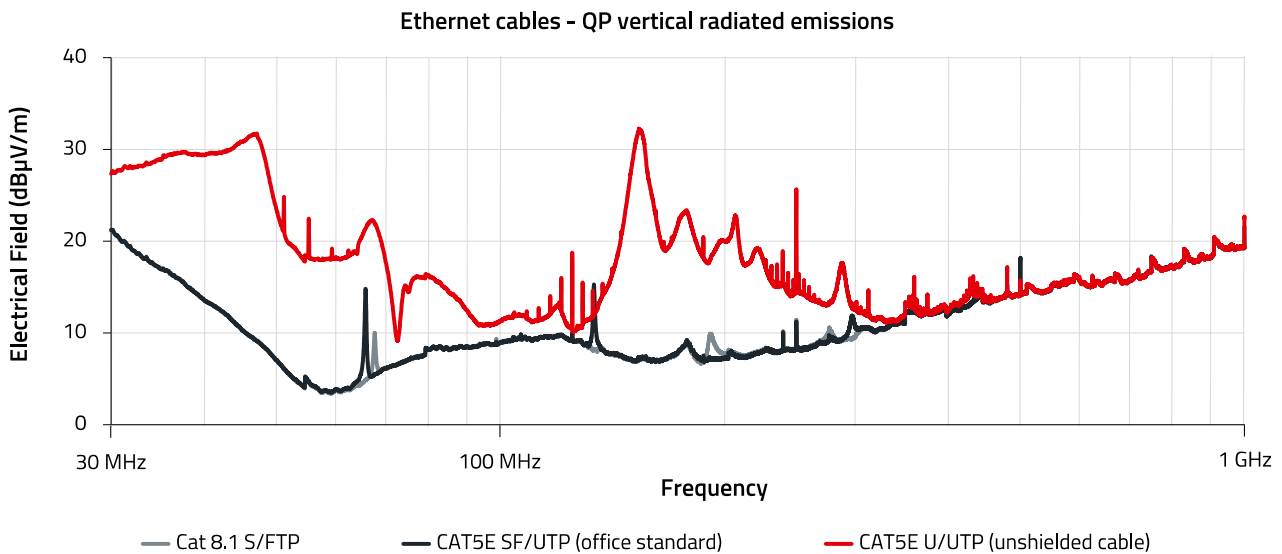

Figure 13: Comparison of radiated interference from different cables with integrated interface design – vertical polarization

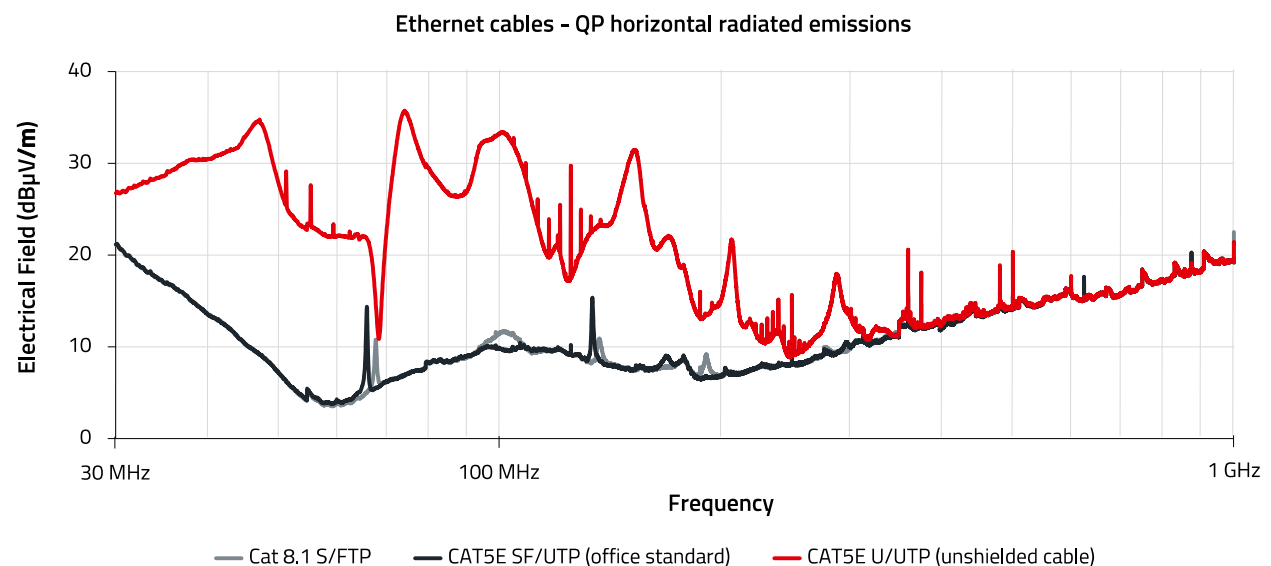

Figure 14: Comparison of radiated interference from different lines with integrated interface design – horizontal polarization

Figure 13 and Figure 14 show that the radiated interference emission with unshielded Ethernet cable is up to 20 dB higher in places than with the two shielded variants. The differences between CAT5E SF/UTP and CAT8.1 S/FTP are smaller, on the other hand. The use of the significantly higher-quality CAT8.1 cable in part reduces the far-field interference emission by 5 dB. Operating with both shielded cables, the interference spectrum is close to the background noise.

Ethernet cables for further consideration

As the results of the two shielded cables are similar, further tests and measurements will be performed with CAT5E SF/UTP (shielded) and CAT5E U/UTP cables.

4.5 Shield connection

As mentioned in section 4.4, different connections of the shield (Ethernet jack) to the electronics (ground plane) can affect the EMC behavior. Different types of contacting are compared here:

1. Full contact: The shield of the jack (chassis) is connected directly to the ground plane of the board.
2. 1 nF Y-capacitor: Classic connection, often mentioned in online sources, consisting of an SMD Y-capacitor and a parallel 1 MΩ SMD resistor.
3. Two 10 nF MLCC capacitors: Capacitive shield connection consisting of two 10 nF MLCCs (100 V type) with a parallel SMD varistor. The varistor

APPLICATION NOTE

ANP116 | Gigabit Ethernet interface from an EMC perspective

protects the capacitors from transient overvoltage damage.

4. One 10 nF MLCC capacitor: Capacitive shield connection consisting of one 10 nF MLCC (100 V type) with a parallel SMD varistor. The varistor protects the capacitors from transient overvoltage damage.

The various shield connections are compared with one another below.

Conducted interference emission

According to CISPR 32, the asymmetric interference on the Ethernet cable is tested using a CDN (Coupling Decoupling

Network). An unshielded CAT5E U/UTP cable is compared with a shielded CAT5E SF/UTP cable with different shield connections.

Ethernet networks are operated in two fundamentally different designs, shielded and unshielded. Figure 15 shows the difference in conducted interference emission. As already shown by the radiation in Figure 13 and Figure 14, the interference on the unshielded cable is 20 dB higher.

Noise on Ethernet cable

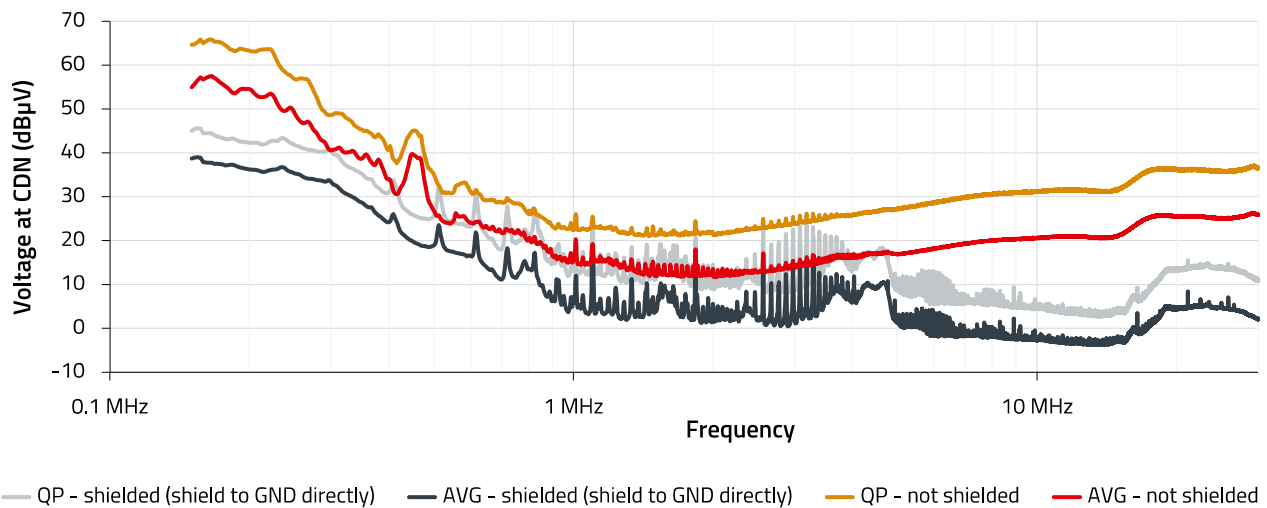

Figure 15: Comparison of interference voltage with shielded and unshielded cables

Noise on Ethernet cable

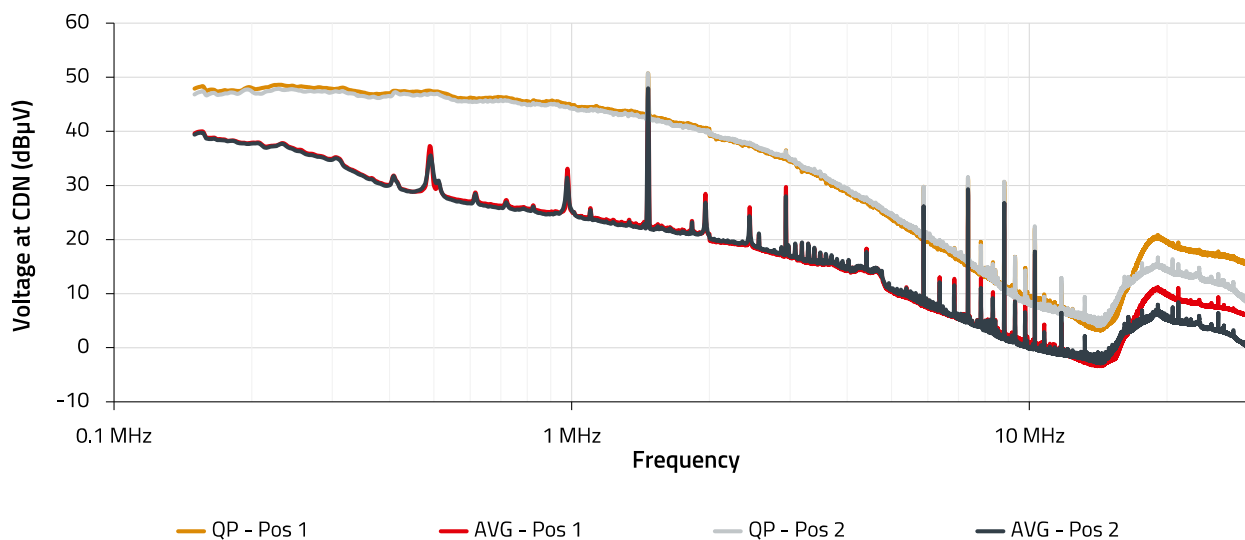

Figure 16: Conducted interference emission on the Ethernet cable. Shield connection with 10 nF MLCC and a varistor, with both components facing each other. Grey vs. red curve: With the position of the two components swapped

APPLICATION NOTE

ANP116 | Gigabit Ethernet interface from an EMC perspective

If a shielded Ethernet jack with only one capacitor is connected to the ground plane of the module, this design is not symmetrical. This can impact the EMC performance, as the interference currents are distributed unevenly in the board structure due to coupling effects.

Figure 16, but also Figure 18 (radiated frequency spectrum) show that the position of the capacitor (right or left of the connector) can influence the interference emission. So connection on both sides is recommended.

The different types of shield connections are tested by measuring the asymmetrical conducted interference emission on the cable shield.

Figure 17 shows that a direct, i.e., low-impedance galvanic

connection (dark blue curve in Figure 17), is preferable from an EMC perspective. Connection with a 1 nF Y-capacitor, which is often mentioned, but has the highest interference emission in the frequency range up to 30 MHz. If capacitive isolation between shield and ground plane, i.e., ground, is required, the configuration with two 10 nF capacitors and a varistor is recommended from an EMC perspective.

Radiated interference emission

The configurations measured for conducted emission were now also checked in the RF interference field. Figure 13 and Figure 14 show these results. The interference emission of unshielded cables is 20 dB higher than that of shielded cables.

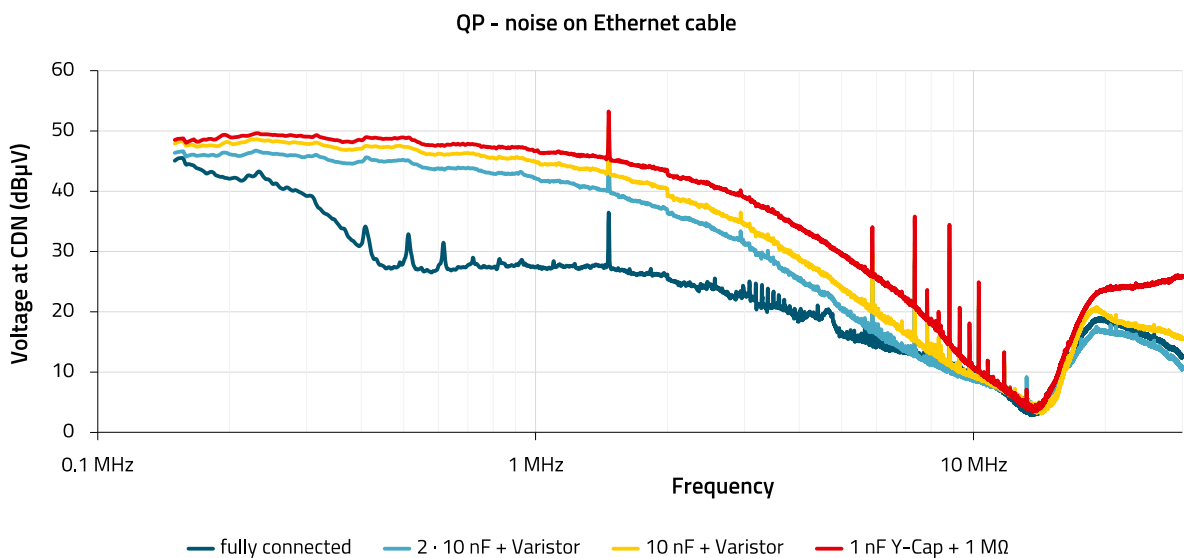

Figure 17: Conducted interference (quasi-peak detector) for different shield connections

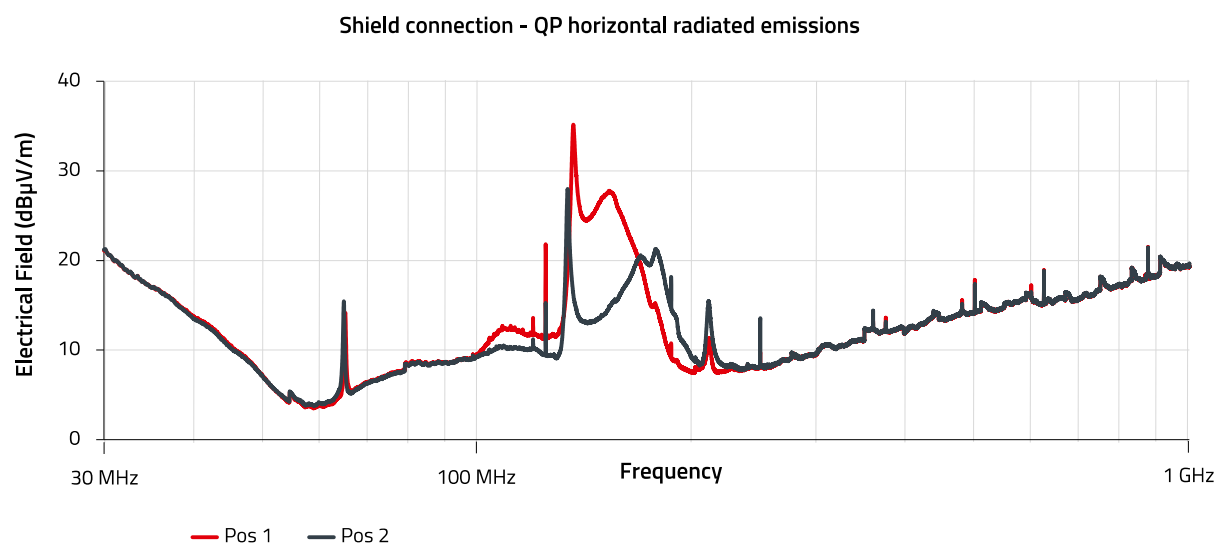

Figure 18: Radiated interference emission in horizontal polarization with connection of the Ethernet line shield using a 10 nF MLCC capacitor and a varistor with the components facing each other. The position of the two components swapped (red vs. grey)

APPLICATION NOTE

ANP116 | Gigabit Ethernet interface from an EMC perspective

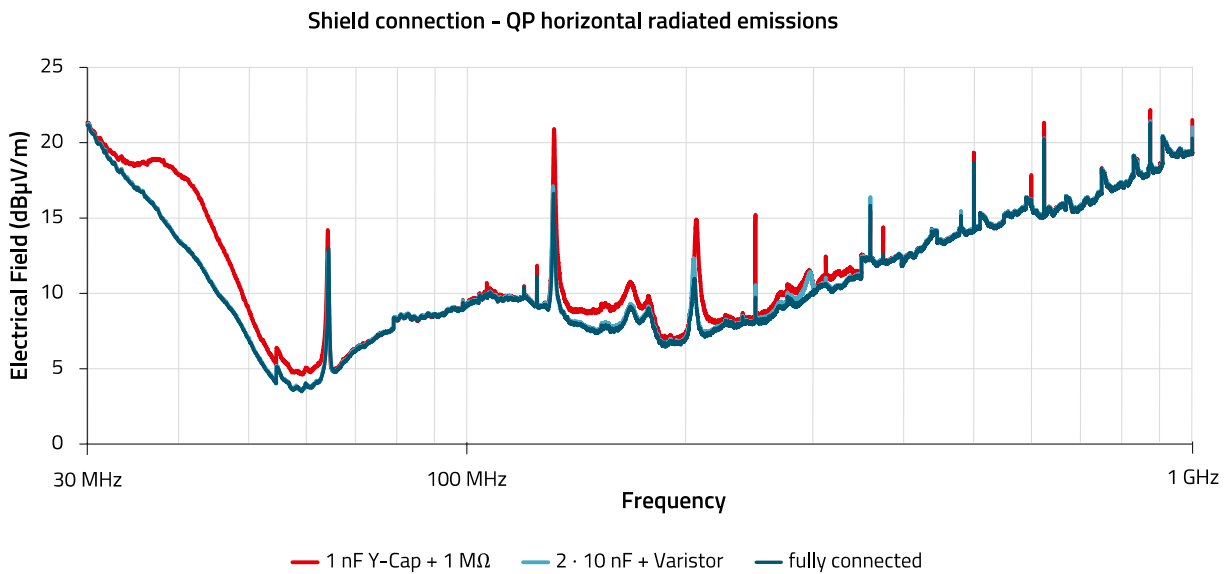

Figure 19: Radiated interference emission with different shield connections in horizontal antenna polarization

The position of the single capacitor was also compared by testing in the RF interference field. The difference is more evident in the radiated emission in Figure 18 than in the conducted emission in Figure 16. Depending on the position of the capacitor, the emission can differ by 10 dB. If this cannot be predicted in the PCB layout process, e.g., by prior experimentation, the effectiveness of the shield connection in the application is left to chance.

As in the case of conducted interference emission testing, different shield connections are also to be compared in the case of radiated interference emission testing. It was previously shown that the position of a capacitor can be relevant. This was observed in Figure 19. Here the direct, galvanic shield connection, the two 10 nF capacitor connections and the connection with only one 1 nF Y-capacitor are compared.

It can be seen from Figure 19 that the interference emission of a shield connection with two 10 nF capacitors is comparable to that with direct galvanic shield connection to the ground plane. Shield connection with a 1 nF Y-capacitor is up to 5 dB worse than the other two variants.

4.6 Radiated interference emission

The results of the radiated interference emission are shown and compared between the discrete and integrated designs. Many results of the reference design with integrated Ethernet transformer were shown in sections 4.4 and 4.5. The following subsections refer at appropriate points to the results already shown.

Measurement results for the integrated Ethernet interface setup

The results are represented in Figure 7, Figure 8, Figure 9, Figure 12 and Figure 13.

Measurement results for the discrete Ethernet interface design

In the discrete design, the reference design is tested with an unshielded cable and a shielded CAT5E SF/UTP cable with the two types of shield connections two 10 nF capacitors, varistor and 1 nF Y-capacitor. As the following figures show, similar to the discrete design, shield connection with two 10 nF is preferable if direct shield connection is not possible.

APPLICATION NOTE

ANP116 | Gigabit Ethernet interface from an EMC perspective

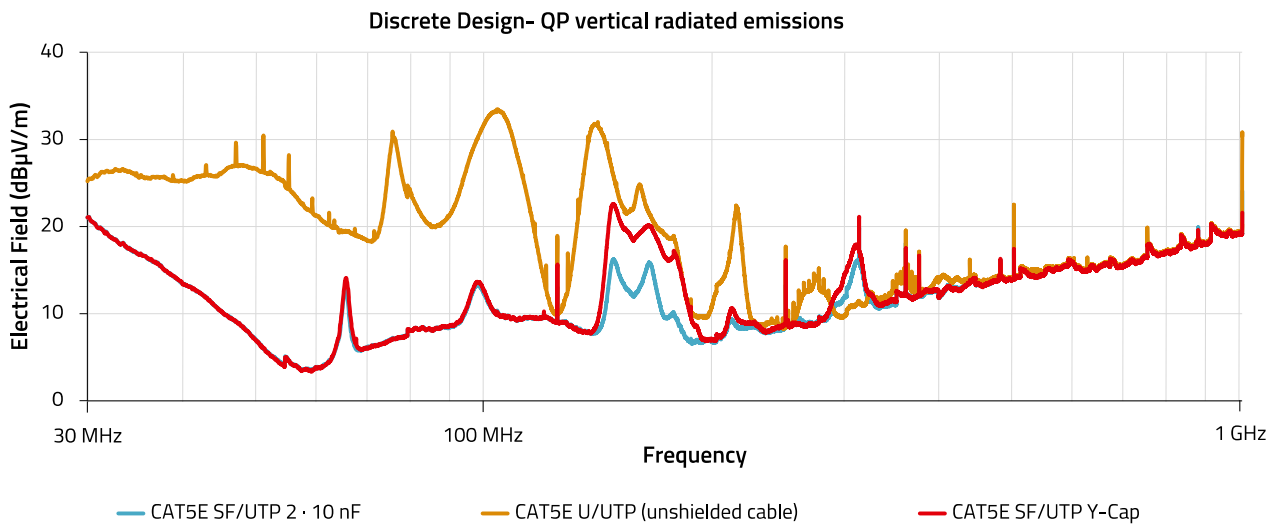

Figure 20: Radiated interference emission with unshielded cables in horizontal antenna polarization

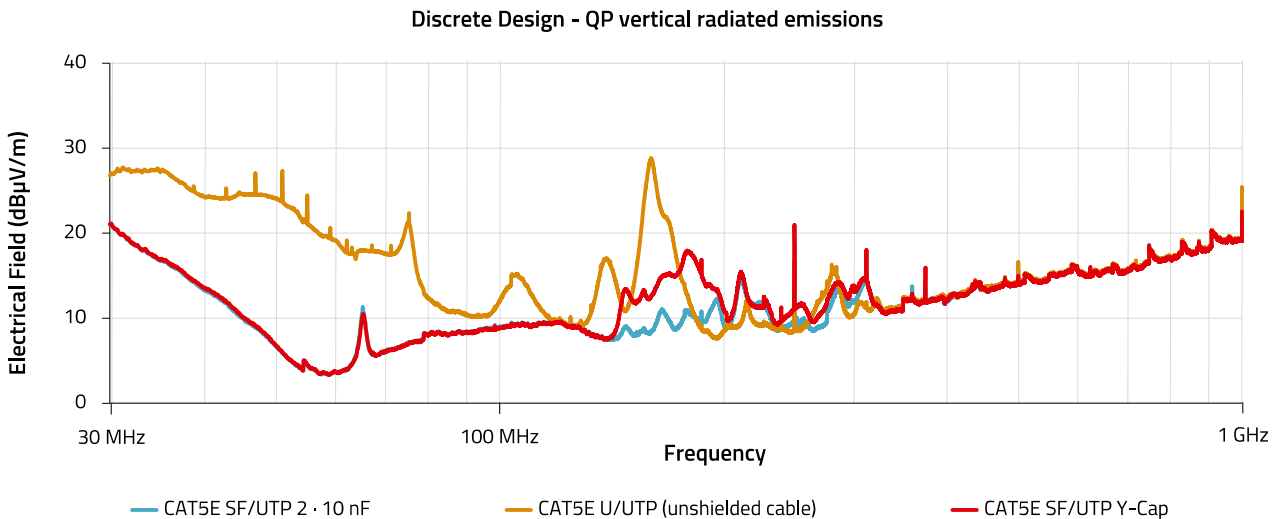

Figure 21: Radiated interference emission with unshielded cables in vertical antenna polarization

Direct comparison of the integrated and discrete interface designs

The following directly compared the two designs with different shield connection. The measurement results for the radiated interference emission are compared with the applicable CISPR32 standard Class B limits.

The following two figures show that the interference emissions of the two designs are comparable if an unshielded cable is used. The board with an integrated Ethernet jack tends to show slightly higher emission in certain frequency ranges.

Both designs are below the Class B limit for residential use in operation with unshielded cable and pass testing. If unshielded cables are used, the margin to the limit value is small, however. The use of shielded cables significantly reduces the radiated interference spectrum.

The lower emission of the setup with discrete components has different reasons. Using a machine-wound transformer enables higher symmetry of the symmetrical interface. However, integration of the components in the integrated Ethernet jack leads to a high component packing density and thus to higher coupling of electric and magnetic fields between the components, which increases the radiation over the Ethernet cable.

Using a shielded cable in both designs reduces the amplitude of the radiated interference spectrum.

APPLICATION NOTE

ANP116 | Gigabit Ethernet interface from an EMC perspective

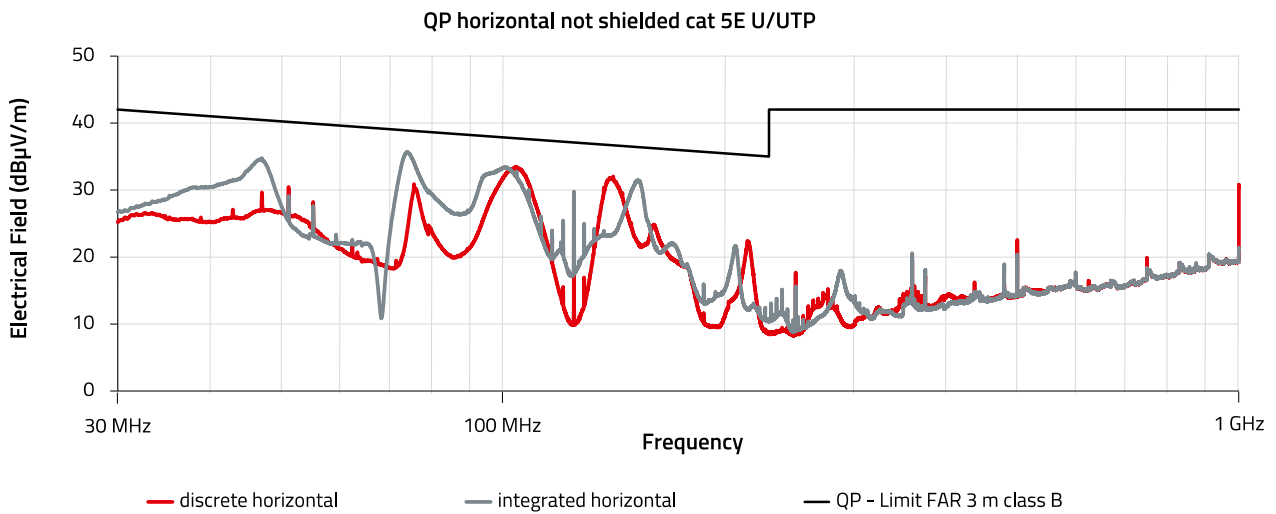

Figure 22: Radiated interference emission with unshielded cables in horizontal antenna polarization

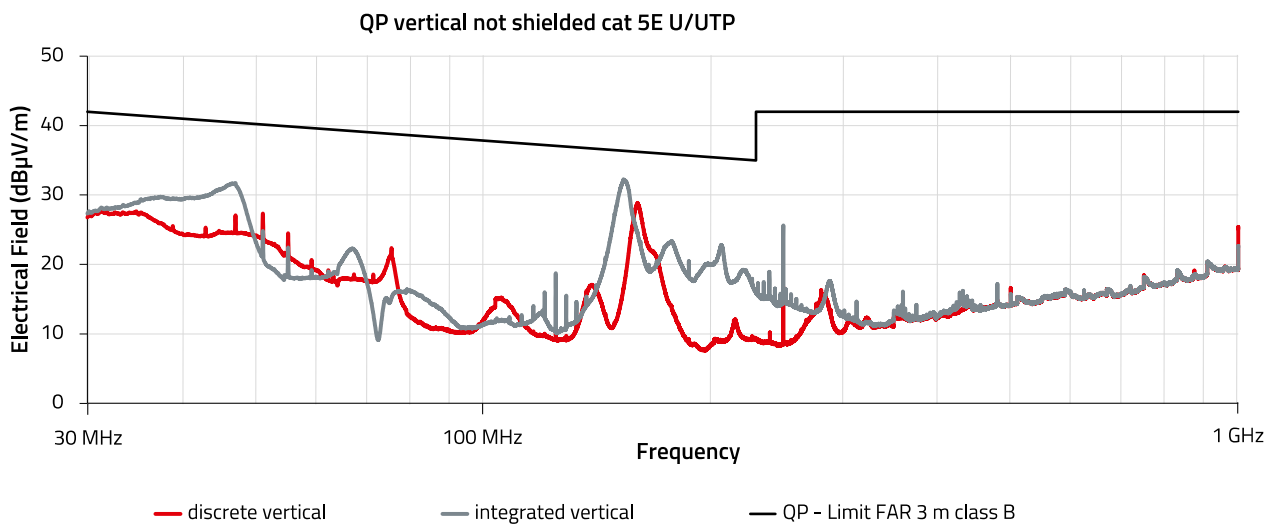

Figure 23: Radiated interference emission with unshielded cables in vertical antenna polarization

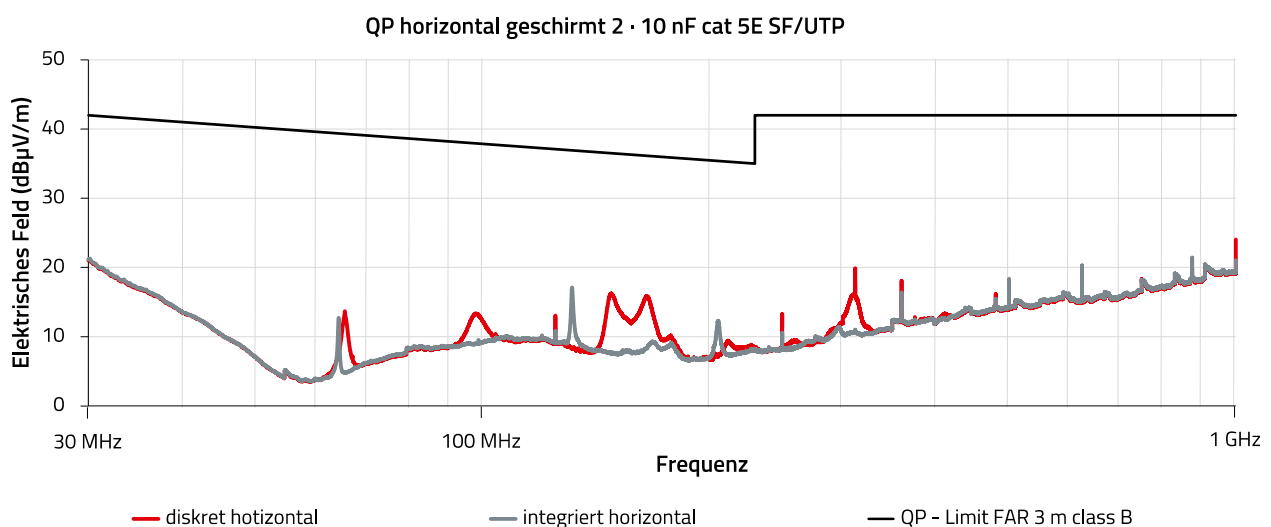

Figure 24: Radiated interference emission during shield connection with two 10 nF-capacitors in horizontal antenna polarization

APPLICATION NOTE

ANP116 | Gigabit Ethernet interface from an EMC perspective

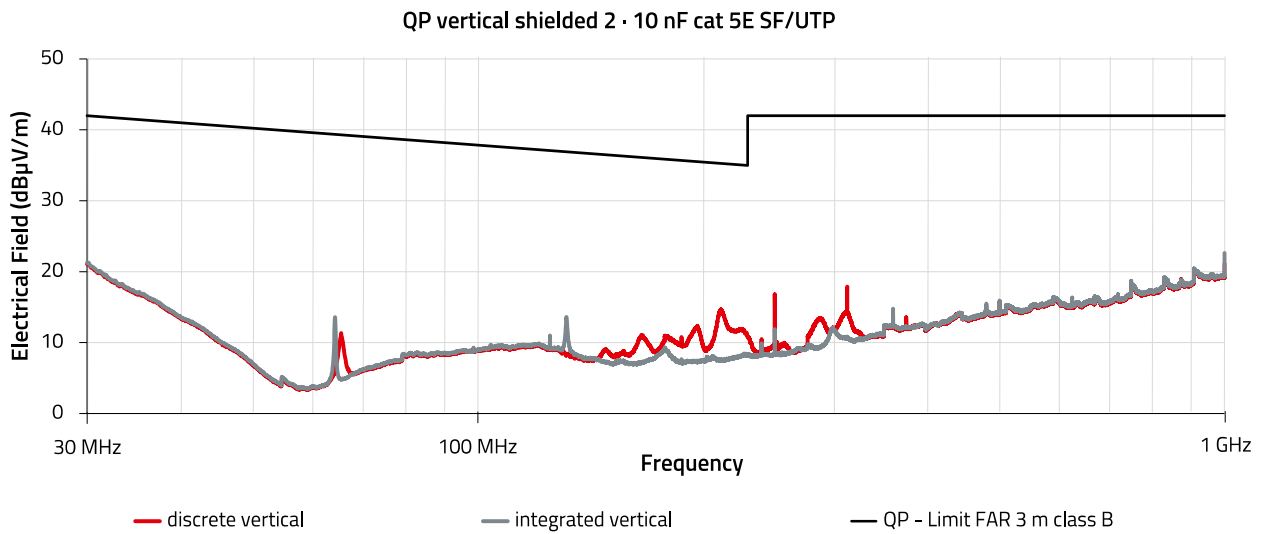

Figure 25: Radiated interference emission during shield connection with two 10 nF Y-capacitor in vertical antenna polarization

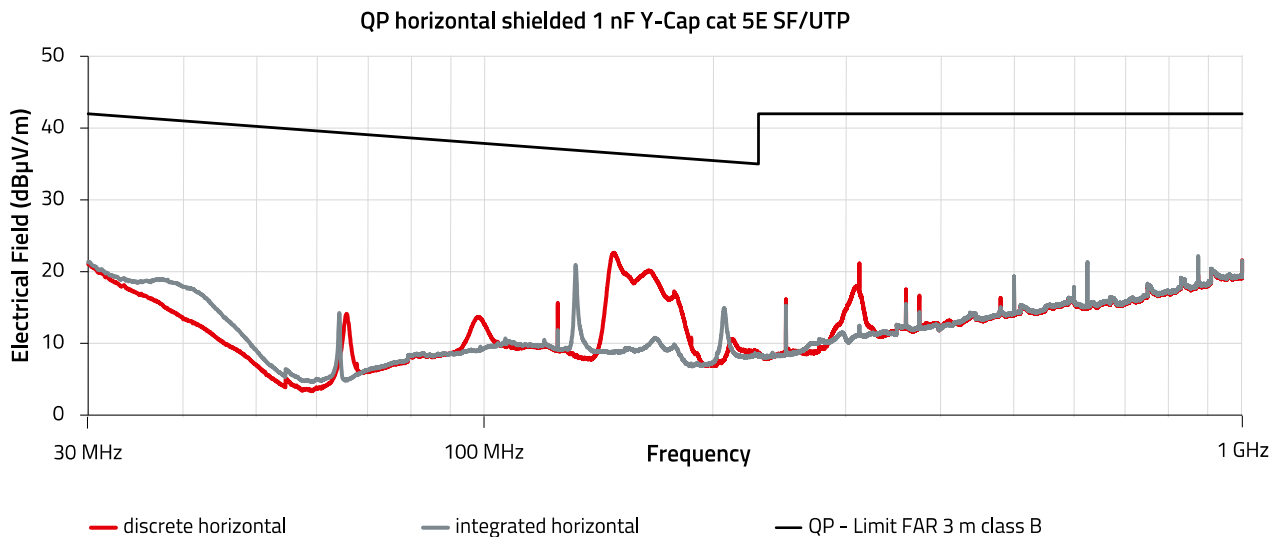

Figure 26: Radiated interference emission, shield connection with one 1 nF Y-capacitor in horizontal antenna polarization

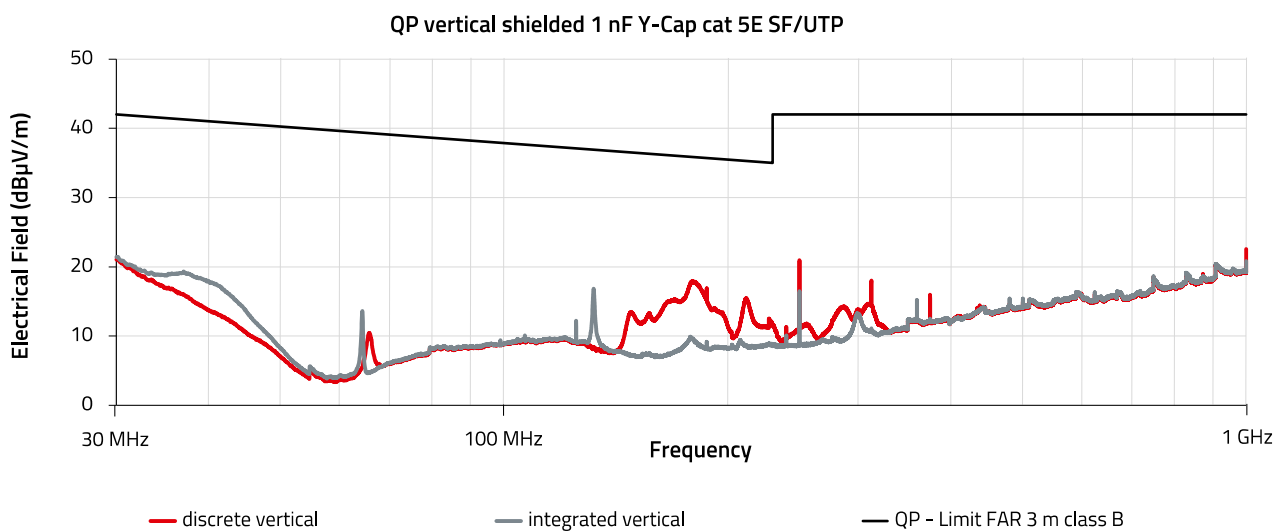

Figure 27: Radiated interference emission, shield connection with one 1 nF Y-capacitor in vertical antenna polarization

APPLICATION NOTE

ANP116 | Gigabit Ethernet interface from an EMC perspective

As previously stated, the shield connection with two 10 nF-capacitors is preferable to use. The designs differ in their radiation, but are comparable in their margin to the limit. The discrete design emits somewhat wider-band interference.

4.7 Conducted interference emission

The results of the conducted interference emission are shown and compared between the discrete and integrated designs.

Many results of the reference design with integrated Ethernet transformer were shown in sections 4.4 and 4.5. The following subsections refer to the results already shown where applicable.

Measurement results for the integrated Ethernet interface design

The results are represented in Figure 9, Figure 10 and Figure 11.

Measurement results for the discrete Ethernet interface design

As expected from the previous results, interference emission is lower with shielded cable, also with the discrete design. In Figure 28 an interface with galvanic, direct shield connection and CAT5E SF/UTP cable is compared with an interface with unshielded CAT5E U/UTP cable. It is clearly the case that the interference level is lower over the entire frequency range for an interface with shielded and direct galvanic connected cable shield.

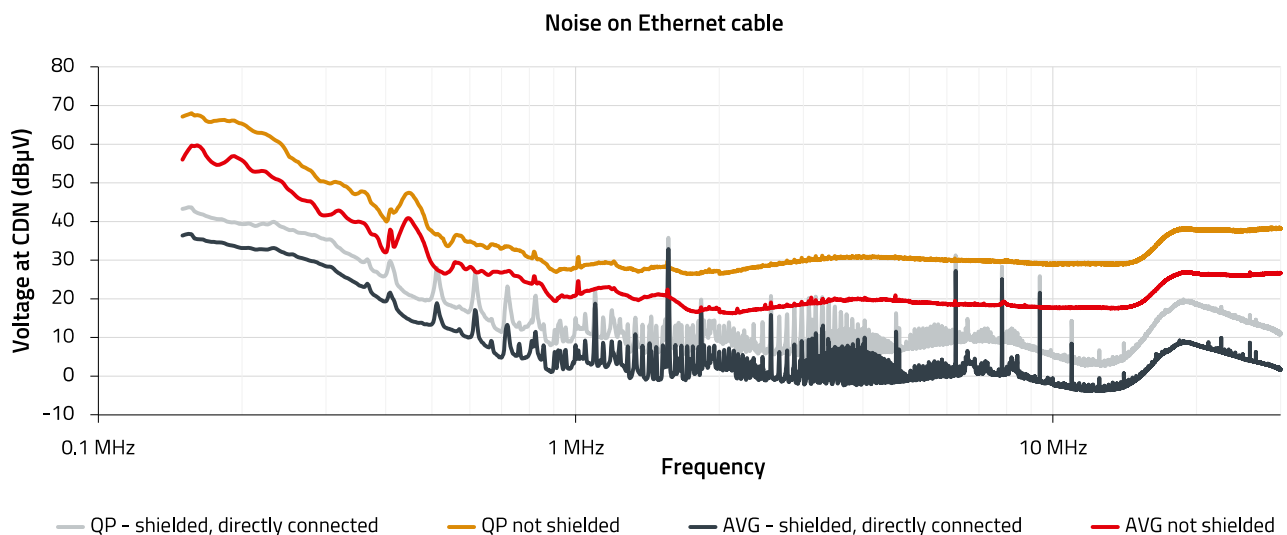

Figure 28: Comparison between shielded, direct galvanic connection and unshielded cable

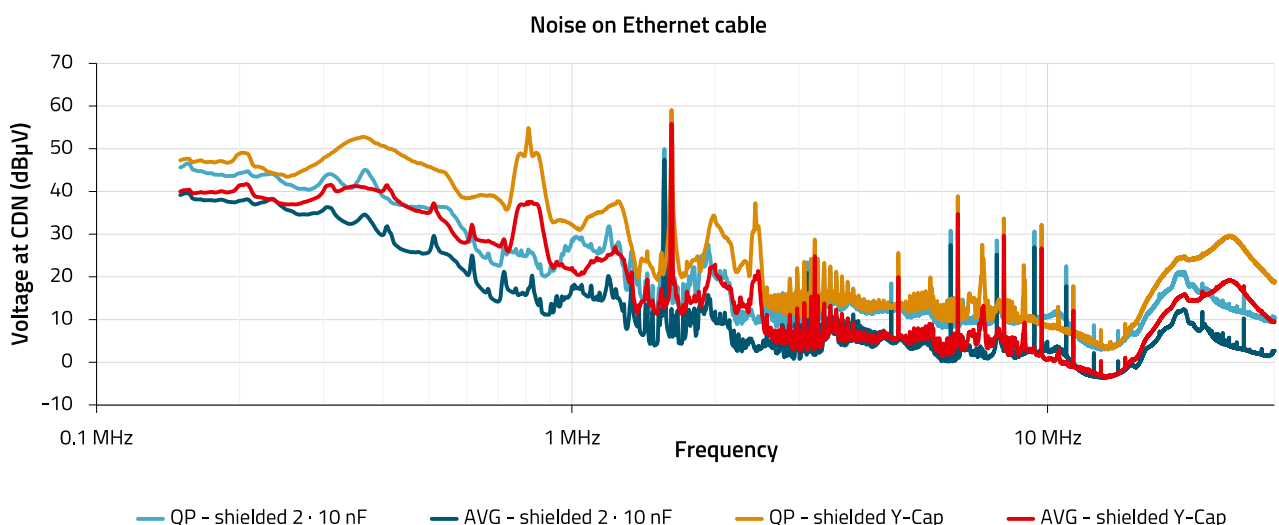

Figure 29: Conducted interference with different shield connection

APPLICATION NOTE

ANP116 | Gigabit Ethernet interface from an EMC perspective

The conducted interference emissions of the two previously proposed shielded connections are compared in Figure 29. Also in the discrete design, the shield connection with one 1 nF Y-capacitor has higher interference emission, and with two 10 nF capacitors and a varistor is preferred.

Comparison of integrated and discrete interface design

The two designs are now compared in the different types of shield connection. The measurement results for conducted interference emission on network lines are compared with the applicable Class B limits.

Using unshielded lines, the two designs are largely similar in their emission (Figure 24). The interference emission in the discrete design is in part slightly higher.

Both designs are consistently below Class B limits by at least 10 dB.

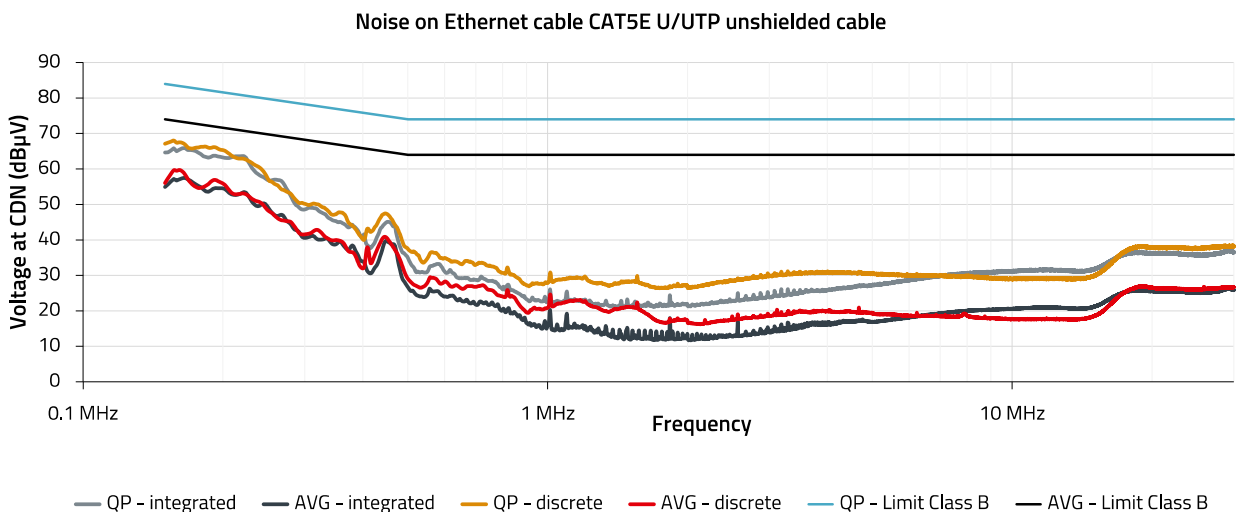

Figure 30: Conducted interference emission with unshielded cables, comparison between discrete and integrated designs

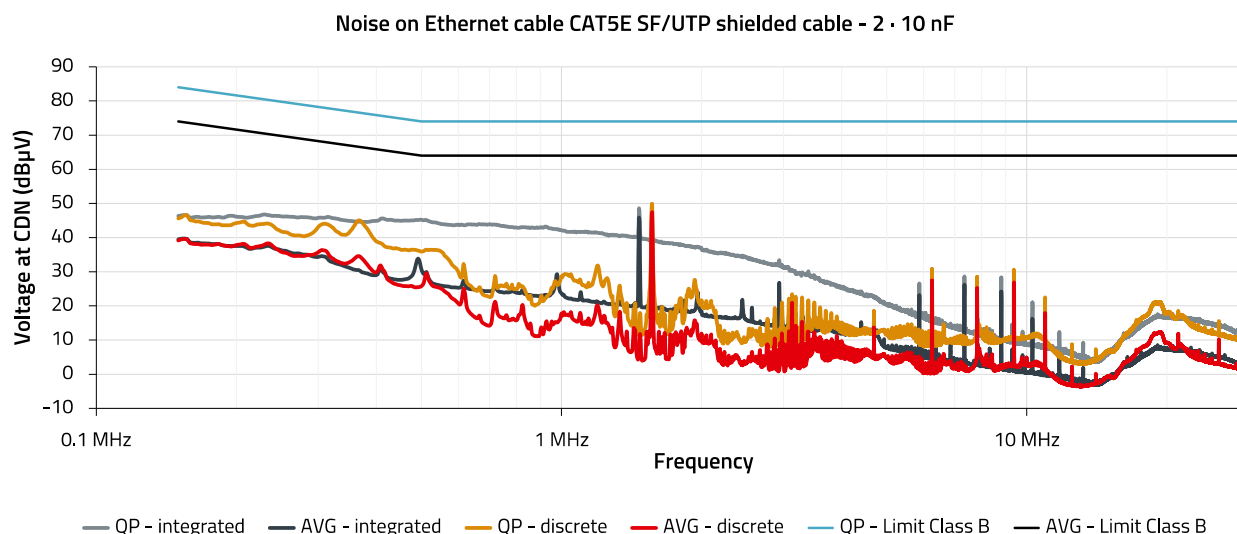

Figure 31: Conducted interference emission with shielded CAT5E SF/UTP cable. Shield connection with two 10 nF capacitors and one varistor

APPLICATION NOTE

ANP116 | Gigabit Ethernet interface from an EMC perspective

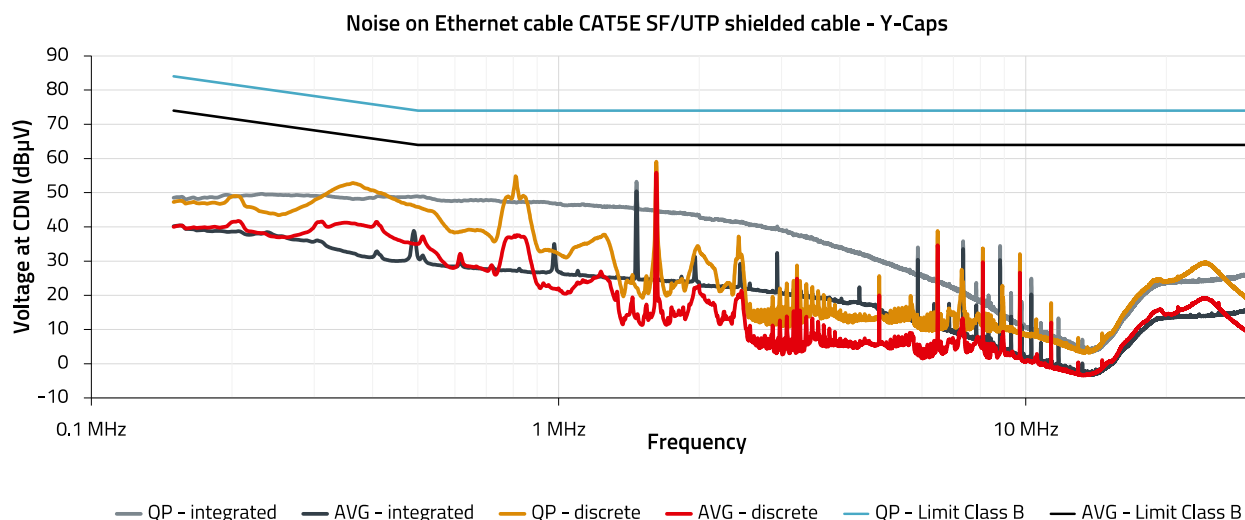

Figure 32: Conducted interference emission with shielded CAT5E SF/UTP cable. Shield connection with one 1 nF Y-capacitor and one 1 MΩ resistor

The types of shield connection compared in Figure 31 differ in their conducted interference spectrum. The level of the individual peaks is similar.

Both designs are below Class B limits by more than 10 dB. The emission spectrum of both interfaces is lower with shield connection with two 10 nF capacitors from Figure 31 than with shield connection with the Y-capacitor in Figure 32.

Figure 32 shows that for shield connection with a Y-capacitor, the integrated design is advantageous. However, the interference level of both designs increases compared to Figure 31. The margin to the limit is thereby reduced and the advantage of shielding is lost due to the capacitor's too small capacitance and the higher parasitic inductance between shield and ground. The disadvantages of shield connection with a Y-capacitor are particularly evident when considering conducted interference. The discrete design is only 8 dB below the mean value limit at 1.6 MHz.

4.8 Radiated interference

Radiated interference immunity is tested according to the IEC 61000-4-3 standard. The exposure time of the field is selected as three seconds to test one complete communication cycle. The evaluation criteria from Table 1 are applied. As IEC 61000-4-3 models continuous interference emitted by radio transmitters and other radio equipment, Evaluation Criterion A is applied. The background is that these radio transmitters transmit continuously. So, should functional error occur during exposure to this

interference, this fact could subsequently lead to inability to use the application in the field.

The designs behave the same during testing, which is why only shielded and unshielded Ethernet cables are distinguished in the following.

Unshielded Ethernet cable

Both designs pass the test at the levels according to Table 2 and thus pass the interference immunity requirements for industrial applications.

Frequency range (MHz)	Interference immunity level (V/M)
80 - 1000	10
1000 - 3000	20

Table 2: Radiated interference immunity level for unshielded CAT5E U/UTP cables

At higher test levels, the data rate drops sharply and connection failures may occur. As unshielded Ethernet cables are uncommon in industrial applications, a good safety margin is provided for residential applications in which unshielded Ethernet cables are commonly used.

Shielded Ethernet cable

The cable shields connection with two 10 nF capacitors or one 1 nF Y-capacitor can be operated at the maximum test field strength available (see Figure 33) in Evaluation Criterion A.

APPLICATION NOTE

ANP116 | Gigabit Ethernet interface from an EMC perspective

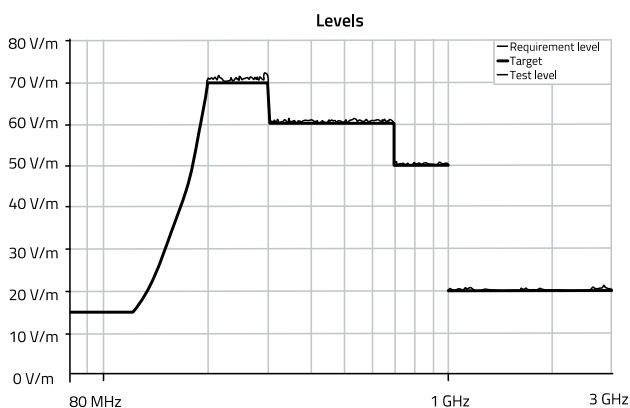

Figure 33: Maximum field strength available in the EMC lab

As the industrial environment in the frequency range up to 1 GHz only requires 10 V/m of interference immunity, the shielded designs offer significantly higher interference immunity than is required.

4.9 Conducted interference immunity

Conducted interference immunity is tested according to the IEC 61000-4-6 standard. Conducted interference immunity extends tests of continuous interference in the frequency range below 80 MHz and simulates coupling through the connected cables into the device. Here it is assumed that interference in the frequency range from 150 kHz to 80 MHz is mainly coupled via the connected cables which serve as antennas. As direct coupling into the interface is physically simpler than generating a high homogeneous electric field, the CDN method is used for this purpose. As the interference is assumed to be continuous, the same evaluation criteria apply as in the previous section 4.8. Even though the USB cable may be longer than 3 m, interference immunity testing on this interface is not carried out here, as this App Note focuses on the Ethernet interface.

Unshielded Ethernet cables

For conducted interference immunity testing, the possible test levels of the two designs differ.

Design	Test level 150 kHz – 80 MHz
Integrated Ethernet jack	10 V
Discrete Ethernet design	3 V

Table 3: Conducted interference immunity level for unshielded cables in Evaluation Criterion A

Conducted interference immunity differs between the designs. The integrated design can meet performance Criterion A at the higher test level for industrial applications. The discrete reference design meets the requirements for residential use. As unshielded Ethernet cables are

uncommon in the industrial environment, the performance is sufficient.

Shielded Ethernet cables

Both designs behave similarly with shield connection using two 10 nF capacitors and a varistor. The interference immunity tests were carried out at a level of 20 V, and both designs were able to meet performance Criterion A. For shield connection with a 1 nF Y capacitor, the integrated design passes the performance Criterion A at a level of 10 V. The discrete board passes Criterion A at 20 V. Thus, in all configurations, at least the industrial noise immunity requirement of 10 V is met.

Design	Test level 150 kHz – 80 MHz	
	Shield connection 1 nF Y-capacitor	Shield connection two 10 nF MLCC
Integrated Ethernet jack	10 V	20 V
Discrete Ethernet setup	20 V	20 V

Table 4: Conducted interference immunity level for shielded CAT5E SF/UTP cables in Evaluation Criterion A

4.10 Transient interference immunity, burst

Burst packets arise when inductive circuits are switched at the switching connection, because opening the inductive circuit causes the voltage at the switching connection to rise until sparking occurs. Burst interference couples strongly into the conductor structure, e.g. parallel conductors. As burst pulses occur when switching inductive loads and not as a continuous interference, Evaluation Criterion B is applied. It should be pointed out at this point that Criterion B may be sufficient from a normative perspective, but may lead to major problems in real daily operation. An example is a sensor that fails briefly during the burst (for example, a photoelectric sensor) and is fully functional again after completion of the test. This may be acceptable for the sensor as Evaluation Criterion B, but if it is installed in a higher-level system this may lead to a system emergency stop (evaluation criterion C + line stoppage). Here it is important with subsystems to ensure that they subsequently also meet the requirements of the overall system. This must also be taken into account in the Ethernet design, and the user of the reference design must decide whether Criterion B is sufficient. An EMC risk analysis could be informative in this case. It should be noted that bursts are very common in practice.

APPLICATION NOTE

ANP116 | Gigabit Ethernet interface from an EMC perspective

The IEC 61000-4-4 standard describes two different test signals with different repetition rates for the individual burst pulses:

1. 5 kHz repetition rate: Historically evolved test signal, which is still preferred in most product standards.
2. 100 kHz repetition rate: More realistic waveform

Experience in EMC lab operation has shown that test devices rarely react to just one type of signal. So it is recommended to test with both signals. The following tests are carried out at both 5 kHz and 100 kHz repetition rates.

Even though the USB cable may be longer than 3 m, immunity testing is not carried out here, as this App Note focuses on the Ethernet interface.

Unshielded Ethernet cable

Both reference designs behave similarly in operation with an unshielded CAT5E U/UTP cable during interference immunity testing. Operation in Evaluation Criterion A is not possible during burst coupling using a capacitive coupling clamp with unshielded cables. Both designs can meet Evaluation Criterion B up to 5.5 kV, however. So when using unshielded cables, although the designs meet the requirements of the product interference immunity standards, it is questionable whether this is sufficient in the real application of the end user. In residential use, where unshielded Ethernet cables are mostly used, Evaluation Criterion B is sufficient, since bursts occur less frequently here and the data rate in the home network is only reduced for a short time.

Shielded Ethernet cable

Using shielded Ethernet cables results in clear differences in performance between the two interface designs. As shown in Table 5, the discrete design allows significantly higher test levels in Evaluation Criterion A. The IEC 61000-6-2 generic standard for interference immunity in industrial environments calls for a test level of +/- 1 kV in Evaluation Criterion B on signal and control connections.

Design	Burst test level with "Pass" in Evaluation Criterion A		
	Shield connection 1 nF Y-capacitor	Shield connection two 10 nF MLCC	Galvanic shield contact
Integrated Ethernet jack	Fail	1 kV	2 kV
Discrete Ethernet setup	1 kV	5 kV	5 kV

Table 5: Performance in interference immunity testing with 5 kHz and 100 kHz burst packets

The results show that shield connection with a Y-capacitor is unfavorable in both designs as compared with direct connection or connection with two capacitors and a varistor.

The setup with a discrete interface with direct, galvanic shield connection allows high burst test levels without loss of performance. So this interface setup is recommended in EMC environments with high transient environmental interference. The reason for the improved performance is the use of a machine-wound transformer [749020310](#), as already explained for the interference emission. This facilitates higher symmetry of the interface and the discrete design enables lower coupling of electric and magnetic fields between the components.

For applications with high performance and high burst load, this means a discrete design is preferable. Nonetheless, both designs pass the industrial interference immunity requirements in Evaluation Criterion A – and can therefore be used for standard applications if the right shield connection is selected.

4.11 Transient surge immunity

The surge test is performed on the Ethernet interface according to the IEC 61000-4-5 standard. Here a distinction must be made between coupling into shielded and unshielded lines. IEC 61000-45 defines shielded cable such that the shield is connected to ground on both sides. Both devices must therefore have shield grounding in the final application. If this is not the case, the interface is considered to be unshielded and the interference is coupled asymmetrically into the cable. As the device manufacturer cannot ensure that this point is covered in all configurations in subsequent use, it is recommended to test both configurations.

APPLICATION NOTE

ANP116 | Gigabit Ethernet interface from an EMC perspective

The USB interface is a local point-to-point interface with a cable length significantly less than 30 m, so for this reason the USB interface is not tested.

Unshielded Ethernet cable

Surge testing on unshielded lines is performed with levels up to 3 kV for both designs. The notebook connected to the USB interface is battery powered. The surge is coupled asymmetrically using a high-speed CDN.

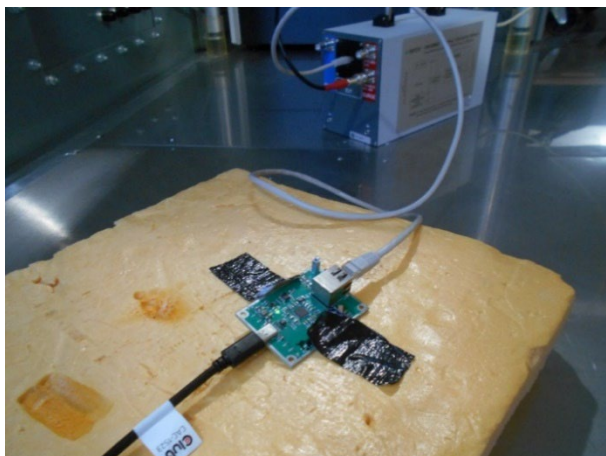

Figure 34: Surge coupling into unshielded Ethernet cable using a CNI 508N2 CDN

The CDN couples the surge towards the test device and provides decoupling on the Ethernet cable towards the notebook. The test can be performed up to a maximum of 3 kV restricted by the CDN limits. The test setup is intended to simulate the interface setup of an unshielded device without a PE connection, as is typically found on IP phones or commercial routers designed for residential use.

Shielded Ethernet cable

Surge immunity was tested with the configuration from Figure 35.

Both designs pass the test for Evaluation Criterion A with shielded, 20 m CAT5E SF/UTP cable with a test level of 5 kV and with the following types of shield connection:

1. Two 10 nF capacitors and one varistor
2. Direct galvanic shield connection
3. 1 nF Y-capacitor



Figure 35: Test setup for direct surge coupling into the cable shield with 2 Ω generator impedance. Surge decoupling by means of an alligator clip and metal bolt on the level of the Ethernet jack – in the picture above left

The setup from Figure 35 assumes that the subsequent final application will have a metallic chassis connected to ground. The surge is therefore not decoupled on the PCB ground, but on the shield GND plane. So the high test current does not flow through the board, but is decoupled at the connection point to the chassis.

05. CONCLUSION

The reference designs feature very high interference immunity, low noise emission and high data transmission rates. Table 6 provides an overview of all tests carried out and the EMC performance of the Gigabit Ethernet designs.

HW-Version	cable	radiated immunity 61000-4-3										conducted immunity 61000-4-6					Surge 61000-4-5				
		emission class B		80 MHz - 1 GHz					1 GHz - 3 GHz		Burst 61000-4-4					Surge 61000-4-5					
		radiated	conducted	3 V/m	10 V/m	20 V/m	30 V/m	max	10 V/m	20 V/m	3 V	10 V	20 V	1 kV	2 kV	4kV	5,5 kV	crit. B lvl	1	2	3
integrated V2.1 4 caps	cat5E U/UTP	pass	pass	nt	pass	fail	fail	nt	pass	pass	nt	pass	fail	nt	nt	200		nt	nt	nt	nt
	cat5E SF/UTP	pass	pass	nt	nt	nt	pass	pass	nt	pass	nt	nt	pass					nt	nt	nt	nt
	cat8.1 S/FTP	pass	nt	nt	nt	nt	pass	nt	nt	pass	nt	nt	nt					nt	nt	nt	nt
integrated V2.1 - 10 nF cap	cat5E SF/UTP	pass	pass	nt	nt	nt	nt	pass	nt	pass	nt	nt	pass	nt	nt	nt	nt	nt	nt	nt	nt
	cat5E SF/UTP (2 Stück)	pass	pass	nt	nt	nt	nt	pass	nt	pass	nt	nt	pass	pass	nt	nt	1700				
integrated V2.1 shorted	cat5E SF/UTP	pass	pass	nt	nt	nt	nt	pass	nt	pass	nt	nt	pass	nt	pass	nt	2300				nt
integrated V2.1 1nF y-Cap	cat5E SF/UTP	pass	pass	nt	nt	nt	nt	pass	nt	pass	nt	pass	fail	nt	nt	200				nt	nt
discrete	cat5E U/UTP	pass	pass	nt	x	x	nt	nt	nt	pass	pass	fail	fail	na	na	300				nt	
	cat5E SF/UTP (2 x 10 nF)	pass	pass				nt	pass	nt	pass	nt	nt	pass	nt	pass	pass	na			nt	nt
	cat5E SF/UTP (full connection)	nt	pass	nt	nt	nt	nt	nt	nt	nt	nt	nt	nt	nt	nt	pass	na			nt	nt
	cat5E SF/UTP (Y-Cap 2 pcs)	pass	pass				nt	pass	nt	pass	nt	nt	pass	pass	nt	nt	2 kV			nt	nt
	cat5E SF/UTP (Y-Cap)	pass	pass				nt	pass	nt	pass	nt	nt	pass	pass	nt	1,5 kV				nt	nt

Table 6: Overview of the EMC performance of the reference designs tested

APPLICATION NOTE

ANP116 | Gigabit Ethernet interface from an EMC perspective

The most important findings of the extensive series of tests are briefly summarized as follows. It was shown that the cable type does not necessarily affect the EMC behavior. The difference between shielded and unshielded Ethernet interface is particularly apparent. For cable lengths between 3 m and 5 m, the different shielded cables had no significant effect on EMC behavior. In tests with unshielded cables, the measured interference levels in the interference emission are significantly higher and the immunity levels lower.

A direct shield connection and direct, short and low-impedance connection between the Ethernet jack and the ground plane is ideal from an EMC perspective. As this design partly conflicts with the requirements of electrical safety or functional aspects (50 Hz equalization currents), capacitive connection may be required. In the case of capacitive shield connection with a capacitor, changing the side to right or left of the Ethernet jack can make a difference in EMC behavior. If capacitive connection is required, then it is recommended to be double-sided. Connection with two 10 nF capacitors is recommended as a low impedance solution and therefore to allow connection even in the lower frequency range. This circuit type comes closest to direct connection. A parallel SMD varistor is recommended to protect the capacitors from transient interference damage.

The use of a shielded cable is recommended for high immunity to continuous interference. A CAT5E SF/UTP cable with a short length of 3 m to 5 m has proven to be sufficient in this case. Error-free and fast data transmission is possible, despite high interference coupling.

The two reference designs differ in EMC behavior, mainly in the tolerance towards high burst levels. The discrete Ethernet interface design is recommended in case enhanced performance is required in EMC environments with very high burst levels, as the interference coupling is lower. Otherwise the EMC behavior of the two board types is largely comparable.

06. FURTHER INFORMATION

The designs used for this App Note are described in detail in Reference Design Note [RDO16](#). The design data is available on the Würth Elektronik homepage to be used freely.

APPLICATION NOTE

ANP116 | Gigabit Ethernet interface from an EMC perspective

IMPORTANT NOTICE

The Application Note is based on our knowledge and experience of typical requirements concerning these areas. It serves as general guidance and should not be construed as a commitment for the suitability for customer applications by Würth Elektronik eiSos GmbH & Co. KG. The information in the Application Note is subject to change without notice. This document and parts thereof must not be reproduced or copied without written permission, and contents thereof must not be imparted to a third party nor be used for any unauthorized purpose.

Würth Elektronik eiSos GmbH & Co. KG and its subsidiaries and affiliates (WE) are not liable for application assistance of any kind. Customers may use WE's assistance and product recommendations for their applications and design. The responsibility for the applicability and use of WE Products in a particular customer design is always solely within the authority of the customer. Due to this fact it is up to the customer to evaluate and investigate, where appropriate, and decide whether the device with the specific product characteristics described in the product specification is valid and suitable for the respective customer application or not.

The technical specifications are stated in the current data sheet of the products. Therefore the customers shall use the data sheets and are cautioned to verify that data sheets are current. The current data sheets can be downloaded at www.we-online.com. Customers shall strictly observe any product-specific notes, cautions and warnings. WE reserves the right to make corrections, modifications, enhancements, improvements, and other changes to its products and services.

WE DOES NOT WARRANT OR REPRESENT THAT ANY LICENSE, EITHER EXPRESS OR IMPLIED, IS GRANTED UNDER ANY PATENT

RIGHT, COPYRIGHT, MASK WORK RIGHT, OR OTHER INTELLECTUAL PROPERTY RIGHT RELATING TO ANY COMBINATION, MACHINE, OR PROCESS IN WHICH WE PRODUCTS OR SERVICES ARE USED. INFORMATION PUBLISHED BY WE REGARDING THIRD-PARTY PRODUCTS OR SERVICES DOES NOT CONSTITUTE A LICENSE FROM WE TO USE SUCH PRODUCTS OR SERVICES OR A WARRANTY OR ENDORSEMENT THEREOF.

WE products are not authorized for use in safety-critical applications, or where a failure of the product is reasonably expected to cause severe personal injury or death. Moreover, WE products are neither designed nor intended for use in areas such as military, aerospace, aviation, nuclear control, submarine, transportation (automotive control, train control, ship control), transportation signal, disaster prevention, medical, public information network etc. Customers shall inform WE about the intent of such usage before design-in stage. In certain customer applications requiring a very high level of safety and in which the malfunction or failure of an electronic component could endanger human life or health, customers must ensure that they have all necessary expertise in the safety and regulatory ramifications of their applications. Customers acknowledge and agree that they are solely responsible for all legal, regulatory and safety-related requirements concerning their products and any use of WE products in such safety-critical applications, notwithstanding any applications-related information or support that may be provided by WE.

CUSTOMERS SHALL INDEMNIFY WE AGAINST ANY DAMAGES ARISING OUT OF THE USE OF WE PRODUCTS IN SUCH SAFETY-CRITICAL APPLICATIONS

USEFUL LINKS



Application Notes
www.we-online.com/appnotes



REDEXPERT Design Platform
www.we-online.com/redexpert



Toolbox
www.we-online.com/toolbox



Product Catalog
www.we-online.com/products

CONTACT INFORMATION



appnotes@we-online.com
Tel. +49 7942 945 - 0



Würth Elektronik eiSos GmbH & Co. KG
Max-Eyth-Str. 1 · 74638 Waldenburg
Germany
www.we-online.com