

APPLICATION NOTE



Peak Current Proof Input Filter with Multilayer Power Suppression Bead WE-MPSB

ANP041 BY RANJITH BRAMANPALLI

1. Introduction

Power supplies are often designed for steady state operation, with transient conditions mainly considered as an afterthought. In practice, transient conditions such as startup, shutdown, and load transients are often far more stressful on the components of the power supply than operation in steady state. To suppress high frequency noise, chip bead ferrites are mainly placed at the input and output of power supplies.

There are two good examples of transients that are often overlooked, but requires merit careful attention. The inrush current occurs when a power supply first starts up or when PWM used for variable loads such as dimming of LED drivers. Chip bead ferrites are often positioned at the inputs and outputs of power supplies where they must endure heavy transient currents, and this creates a need for compact, cost effective devices that are also highly reliable. Such ferrites are placed at the input and output because they are very effective at filtering the high frequency noise in switching regulators. The high frequency noise results from rapid switching currents ringing with parasitic inductance and capacitance. Such noise tends to occur at frequencies from 50 MHz to 500 MHz and is known as “ringing”, “spikes” or “periodic and random deviation noise” (PARD noise). Figure 2 shows PARD at the origin, the switching node, and also shows how PARD noise shows up at the input and output of the switcher.

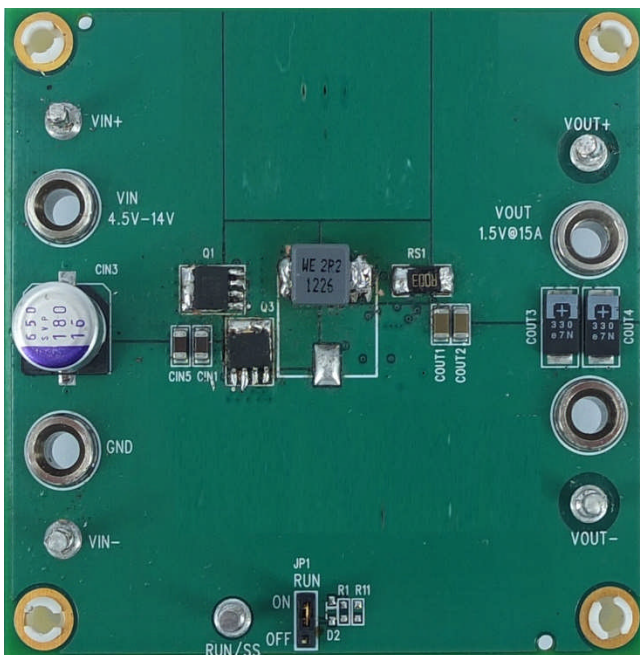

Figure 1: Initial Test Circuit without Chip Bead Ferrites

Zooming in and measuring the frequency of PARD noise in Figure 2 reveals a frequency of 170 MHz. Conducted noise like the waveforms in Figure 2 will generate radiated noise if it leaks onto input and output wiring harnesses.

In general, chip bead ferrites should be always placed as close as possible to the converter as source of noise. However, one effective method for preventing PARD noise from getting into the input and output leads of a switching power supply is to place chip bead ferrites in series with the inputs and outputs. As shown in

APPLICATION NOTE



Peak Current Proof Input Filter with Multilayer Power Suppression Bead WE-MPSB

Figure 3, these should be placed as close as possible to the edge of the PCB and/or to the connectors, and footprints for ferrites should be placed in series with both the positive and the negative of each connector.

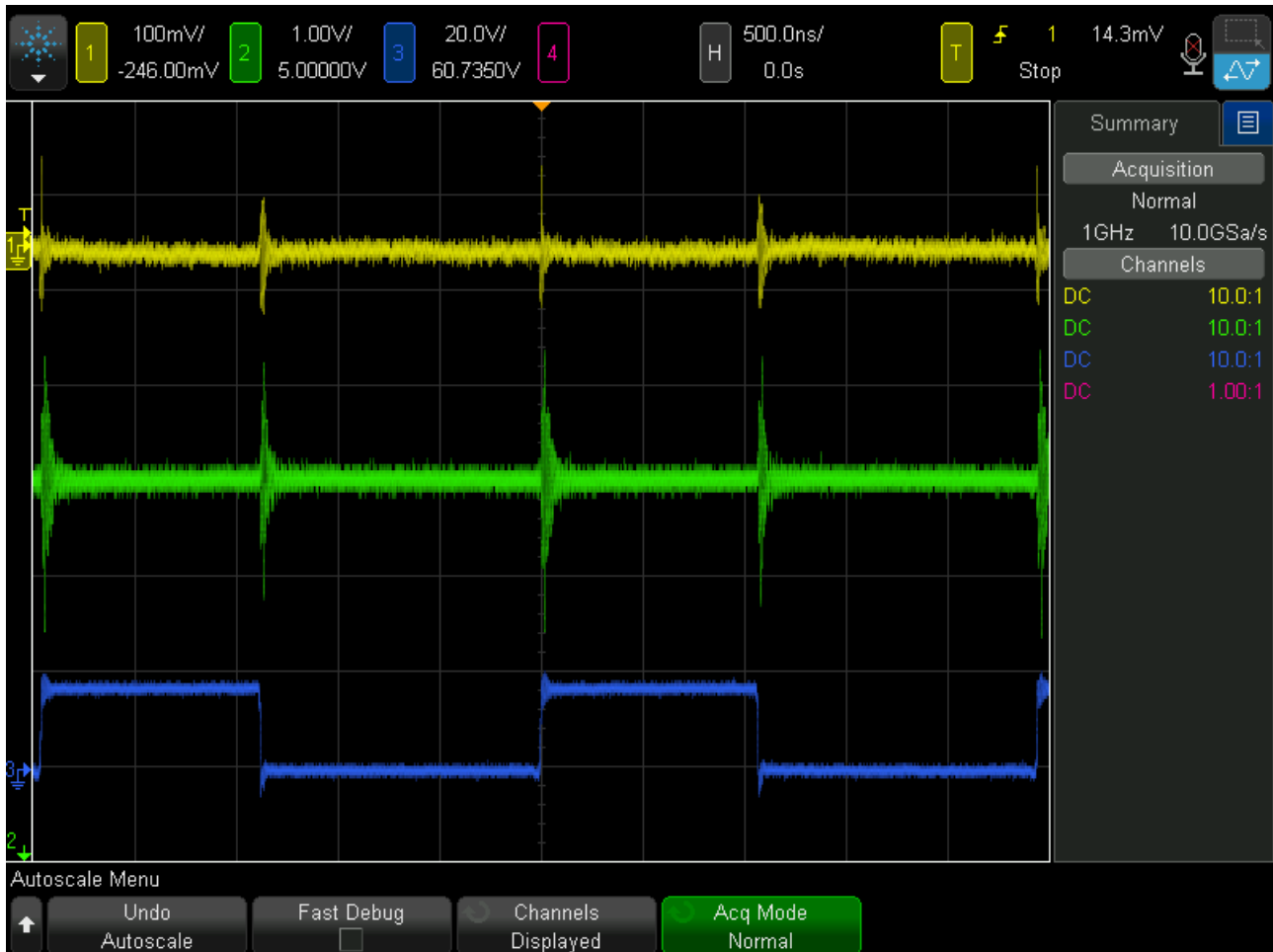

Figure 2: PARD noise without Chip Bead Ferrites starts at the switching node of a buck converter (blue) and contaminates the input voltage (yellow) and the output voltage (green)

Again, in general ferrites should be placed as close as possible to the source of the noise because the noise couples into the unfiltered traces and cables. However, be aware that it is very likely that high frequency noise can couple around a ferrite via parasitic capacitance to GND and earth planes. Most EMC standards begin limiting radiated EMI at 30 MHz, so preventing this unwanted antenna effect of input and output leads is highly important. When a ground plane or a shielded enclosure is present, noise can couple around a ferrite placed towards the interior of a PCB, as shown in Figure 4.

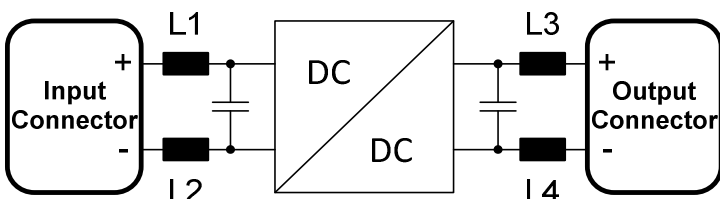

Figure 3: Generic DC-DC converter with chip bead ferrite beads L1-L4 at the inputs and outputs

APPLICATION NOTE



Peak Current Proof Input Filter with Multilayer Power Suppression Bead WE-MPSB

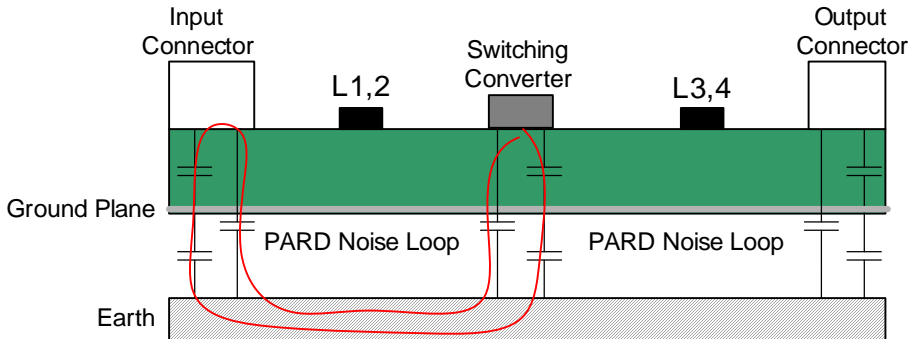

Figure 4: PARD noise gets around chip bead ferrite beads L1-L4 by coupling capacitive through the ground plane and earth to the input and output connectors

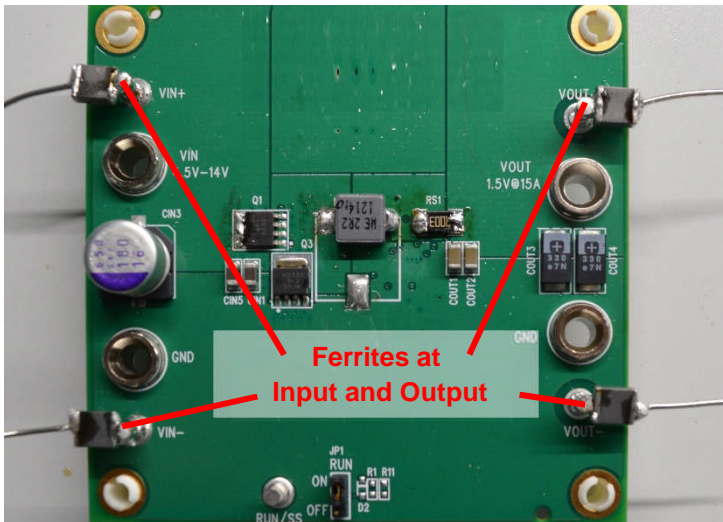

Figure 5: Generic DC-DC converter with chip bead ferrites L1-L4 at the inputs and outputs to prevent PARD noise

Würth Elektronik eiSos has recently developed a family of chip bead ferrites that feature high average / RMS current ratings, low DC resistance and are also tested and specified for high current pulses. This peak current proof series, the [WE-MPSB](#) Multilayer Power Suppression Bead family, is especially suitable for use in positions where short-duration currents far exceed the average currents.

APPLICATION NOTE



Peak Current Proof Input Filter with Multilayer Power Suppression Bead WE-MPSB

2. Inrush Currents at Turn-On

At the moment when a power supply is turned on, any capacitors connected to the input bus will begin to charge. In some very rare cases, a soft-start of the input supply controls the ramp in a smooth, monotonic behavior, but in most cases, the input voltage ramps up very quickly. For example, if the 12 VDC power bus in Figure 6 is already up and running when a mechanical switch connects it to the buck converter, the ramp slope is only limited by the source resistance and the resistance and parasitic inductance of the leads/PCB traces/switch. For this application note the resistance and inductance of a 30 cm banana-to-banana test cable was measured and came out to 8 mΩ and 0.3 μH, respectively. In practice all voltage sources are current limited, but if the 12 VDC bus had a large amount of output capacitance, a fact for the laboratory DC power supply used in this application note, then the charging current when the mechanical switch closed could easily exceed 30 A as shown in Figure 7.

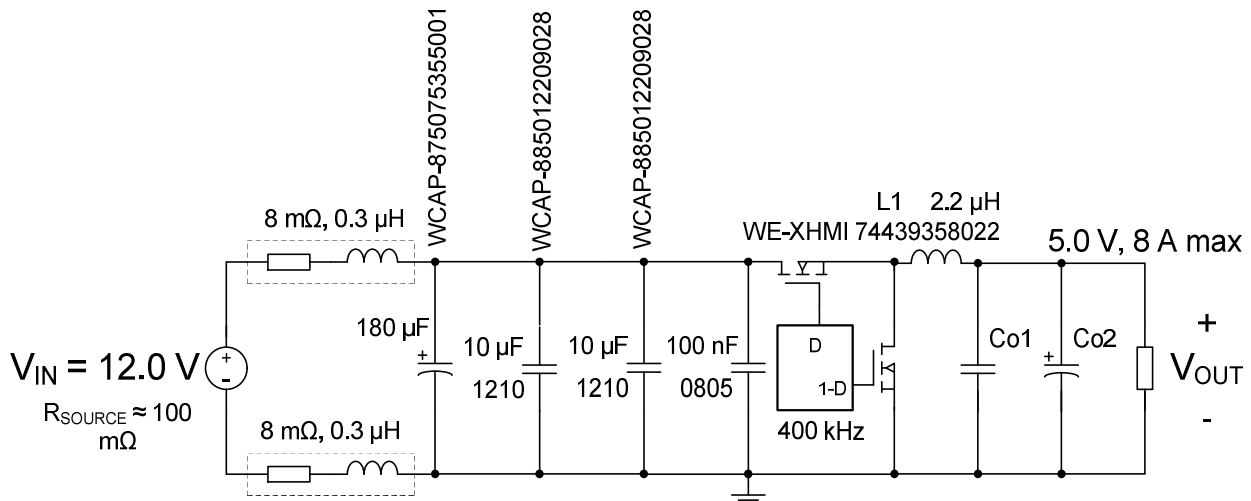

Figure 6: Schematic of the test buck converter showing source resistance, input lead resistance and inductance along with all input capacitors

APPLICATION NOTE



Peak Current Proof Input Filter with Multilayer Power Suppression Bead WE-MPSB

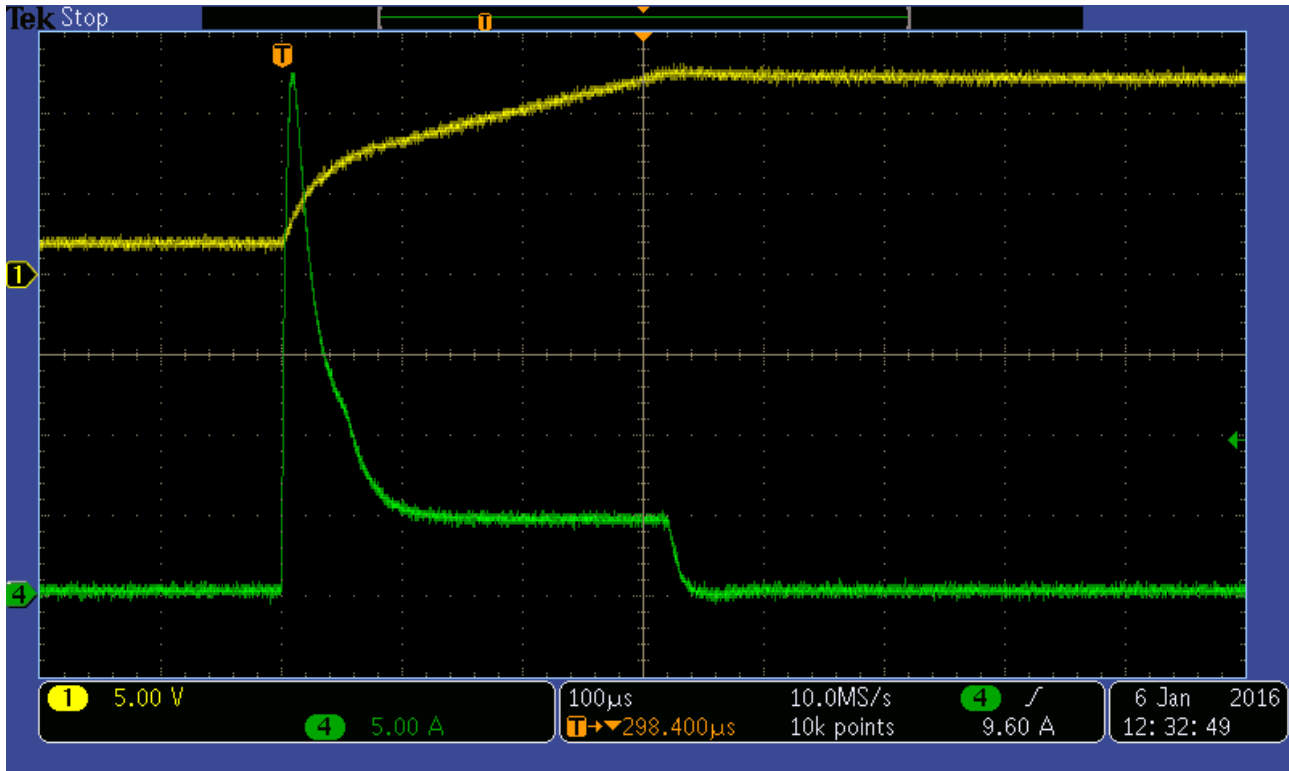

Figure 7: Input inrush current of 33 A for a 12 VDC bus with a near-instantaneous connection charging 20 µF of ceramic and 180 µF of polymer aluminum input capacitance

Figure 7 shows a pulse that peaks at approximately 33 A and settles after around 100 µs to the 5 A current limit of the laboratory power supply used as the input source. It then takes another 200 µs to charge the input capacitors up to the target 12 V. Compare this waveform to the steady state input source current:

$$I_{\text{source, max}} = \frac{V_{\text{out}} \cdot I_{\text{out, max}}}{\eta \cdot V_{\text{in, min}}} = \frac{5 \text{ V} \cdot 8 \text{ A}}{0.95 \cdot 11.4 \text{ V}} = 3.7 \text{ A} \quad \text{EQ.1.}$$

(η is the measured power efficiency of 95%)

The compromise facing the circuit designer becomes evident: any input filter components must be able to handle heavy current pulses each time the converter is switched on, but selecting ferrites rated to handle the full pulse current leads to overdesign for steady state.

3. Outrush Currents at Turn-On

Figure 8 shows the same test buck converter but focusing on the output. The converter has two polymer aluminum 330 µF output capacitors with 20 mΩ of ESR each and two 100 µF multi-layer ceramic capacitors with approximately 3 mΩ of ESR each. This capacitor bank is capable of supplying large pulses of current in a short time. The same 30 cm cables were used to connect the 5.0 V output to a load that draws the maximum of 8 A of output current, and Figure 9 shows that when the 8 A load is connected with a fast rise time the current transient comes close to 25 A.

APPLICATION NOTE



Peak Current Proof Input Filter with Multilayer Power Suppression Bead WE-MPSB

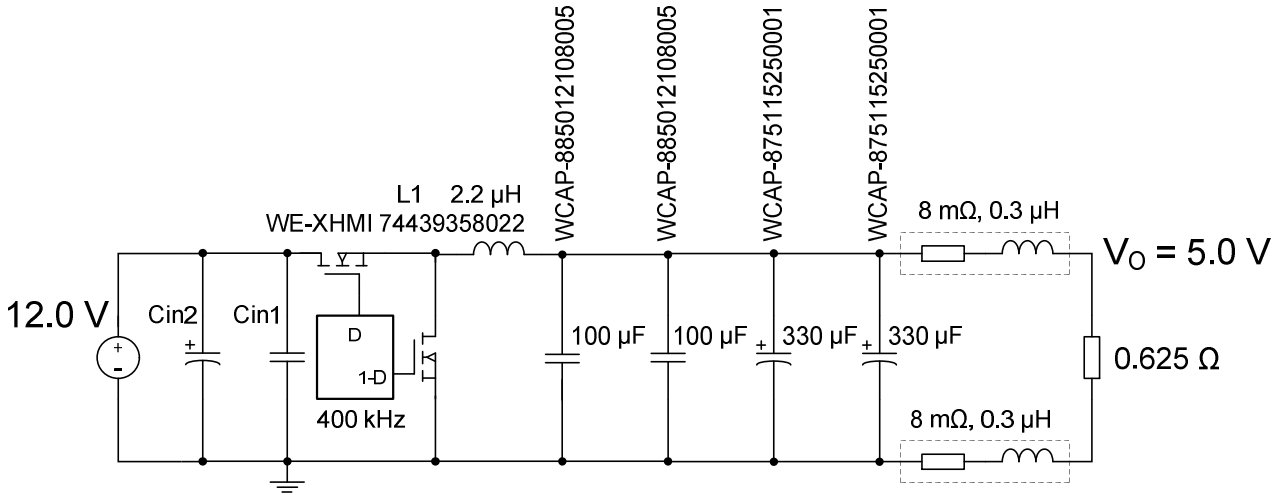

Figure 8: Schematic of the test buck converter showing load resistance, output lead resistance and inductance along with all output capacitors

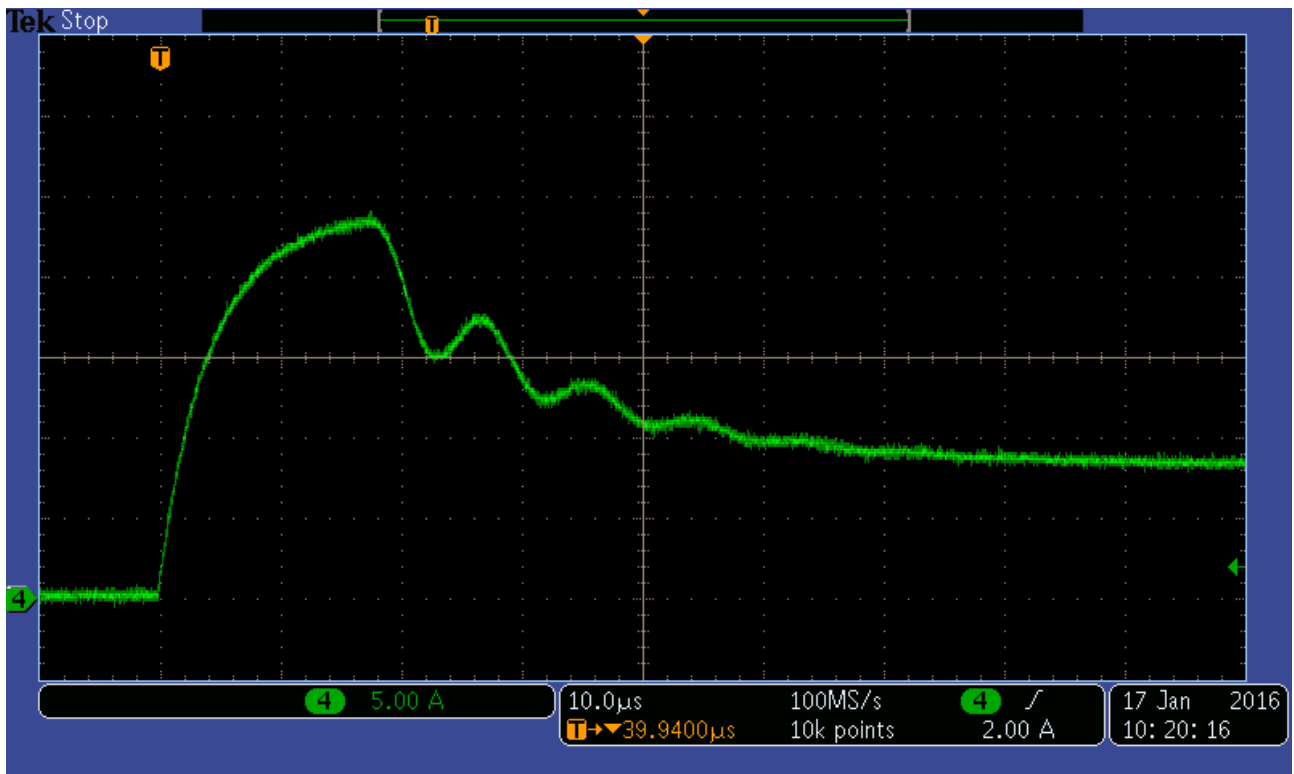

Figure 9: Outrush current for a 5 VDC bus with a near-instantaneous connection to an 8 A load with 200 μF of ceramic and 660 μF of polymer aluminum output capacitance

APPLICATION NOTE



Peak Current Proof Input Filter with Multilayer Power Suppression Bead WE-MPSB

4. Using WE-MPSB Multilayer Power Suppression Bead

4.1. Problems with Steady State Current Ratings

The [WE-MPSB](#) family was designed to provide a similar range of impedances as the standard, [WE-CBF](#) family of chip bead ferrites. The [WE-CBF](#) family provides RMS current ratings, but like nearly all other chip bead ferrites from any manufacturer, no peak or pulse current ratings. In this example, in order to handle a 33 A pulse with steady state specifications multiple [WE-CBF](#) family devices would be needed, since the highest RMS current rating in this family is 6 A, for the 1806 or 1812-sized devices. Just one [WE-CBF](#) family device, for example the 4 A-rated [742 792 150](#) with a 1206 case size and rated 80 Ω at 100 MHz would handle the steady state current, but repeated startup transients could lead to failures such as the ones depicted in Figure 8.



Figure 10: Melted and burned chip bead ferrites due to overcurrent and overheating

Six such devices would be needed for the positive input line and another six for the negative input line, and this is not practical for several reasons: First, chip bead ferrites can be paralleled for continuous currents and their positive temperature coefficient will ensure that they share current more or less evenly. However, such current sharing is neither tested nor guaranteed for short-duration pulse currents. Second, placing several components in parallel with impedance that is dominated by resistance and inductance causes the inductance, the resistance and the impedance to drop, making them far less effective at filtering the desired noise. Third, six components cause high costs and need much PCB space.

4.2. Select the proper WE-MPSB

In situations where peak currents exceed average current by ratios from 3:1 to nearly 10:1 WE-MPSB are typical area of use. A first pass for selecting chip bead ferrites is to review all parts that can handle the RMS current of 3.7 A.

4.2.1. Peak Current Proof Ferrites for the Input

In our application we are expecting 10 000 switching cycles during lifetime, so 10 000 pulses with 33 A will stress the WE-MPSB of the input filter and needs to be survived. The first step and most comfortable way is to enter these data into the pulse designer of **REDEXPERT**. There are 9 parts left, which we took all in the *product storage* for easy comparison.

APPLICATION NOTE



Peak Current Proof Input Filter with Multilayer Power Suppression Bead WE-MPSB

Filter	Pulse
System	PARAMETERS
Pulse	<p>Single Pulse</p> <p>I 33 A Length 0.5 ms</p> <p>Pulse Repetition for 8ms Pulses</p> <p>Number 10 k I 33 A</p>

Figure 11: Enter the pulse length, peak current and number of pulses

4.2.2. Validation of Effective Resistance

From the 9 left [WE-MPSB](#) we now select the one with the highest resistance (not total impedance) at the noise frequency. In general chip bead ferrites have their highest resistance at the frequency of their highest total impedance, but for other frequencies there is no general approximation possible. The fastest way to find the best part is using **REDEXPERT** from Würth Elektronik (www.we-online.com/redexpert). As a registered user you can place the chart slider at 170 MHz (see Figure 12), and read directly the resistance values of each part out of the grid, and even sort descending to get the part with highest resistance.

APPLICATION NOTE



Peak Current Proof Input Filter with Multilayer Power Suppression Bead WE-MPSB

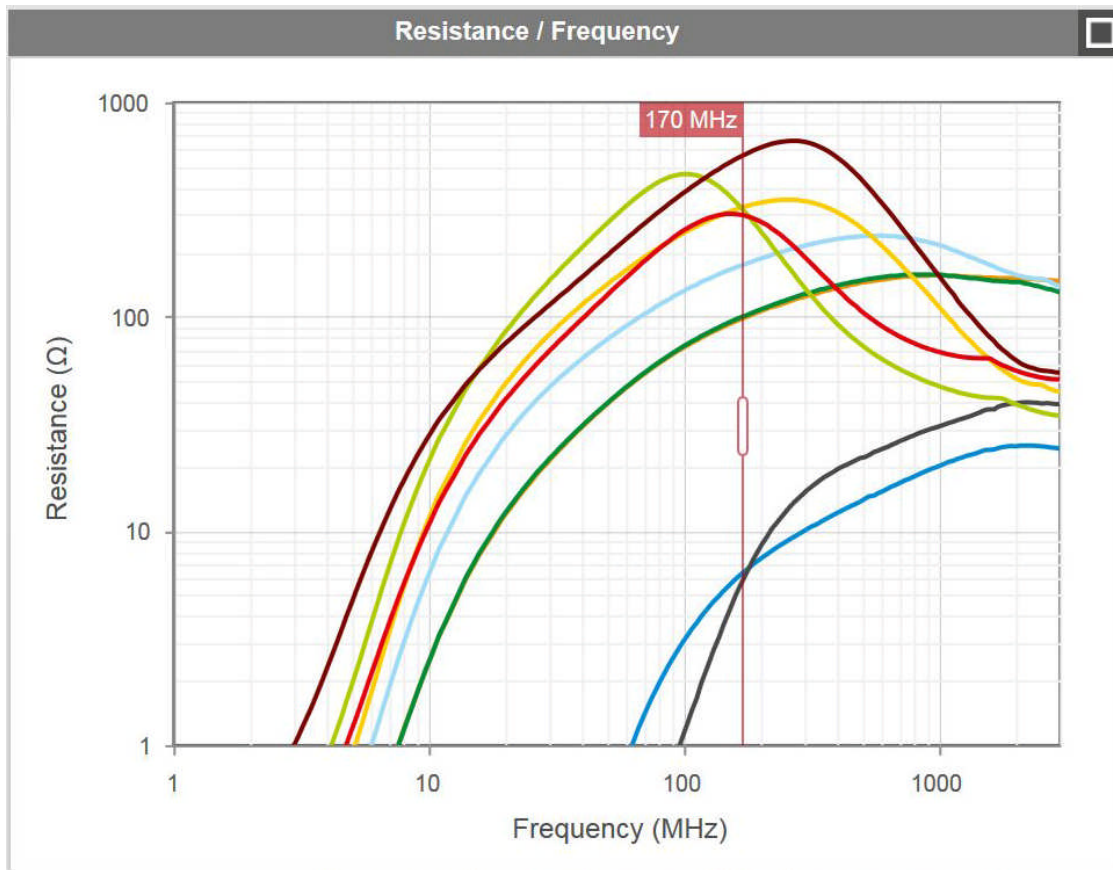

Order Code	Series	Size	Spec	Type	N @33.0 A	Z	R @170 MHz	R _{DC}	I _R
Filters: I _R ≥ 3.70 A * N @33.0 A ≥ 10.0 k * Series = WE-MPSB *									
74279224251	WE-MPSB	2220		High Current	18.7 k	250 Ω @100 MHz	298 Ω	12.0 mΩ	4.00 A
74279224181	WE-MPSB	2220		High Current	62.5 k	180 Ω @100 MHz	174 Ω	10.0 mΩ	5.00 A
74279224101	WE-MPSB	2220		High Current	11.3 k	100 Ω @100 MHz	99.8 Ω	5.00 mΩ	7.00 A
74279226101	WE-MPSB	1812		High Current	11.3 k	100 Ω @100 MHz	97.8 Ω	6.00 mΩ	8.00 A
7427922808	WE-MPSB	0603		High Current	15.7 k	8.00 Ω @100 MHz	6.32 Ω	2.50 mΩ	9.50 A
74279221100	WE-MPSB	1206		High Current	27.2 k	10.0 Ω @100 MHz	5.78 Ω	1.00 mΩ	10.5 A

Figure 12: Determine the best suitable WE-MPSB with REDEXPERT leads to [742 792 245 51](#)

Considering all of above parameters the red highlighted part [WE-MPSB 742 792 245 51](#) seems to be the best suitable component for our application. Its current rating is 4.0 A, and it can withstand about 18 700 pulses of 33 A and 8 ms length. Keeping in mind that this 8 ms is much longer than the initial pulse of 500 μs and the short peak of 100 μs, gives it a plenty safety margin. From all suitable components, it is the one with the highest resistance at 170 MHz.

APPLICATION NOTE



Peak Current Proof Input Filter with Multilayer Power Suppression Bead WE-MPSB

4.2.3. Pulse-Stable Ferrites for the Output

The output RMS current is the same as the average output current of 8.0 A. Following the same guidelines, there are five candidates rated for greater than 8.0 A:

Order Code	Series	Size	Spec	Type	N @ 25.00 A	Z	R @170 MHz	R _{DC}	I _R
74279225101	WE-MPSB	3312		High Current	17.0 k	100 Ω @100 MHz	110 Ω	4.00 mΩ	10.0 A
74279226101	WE-MPSB	1812		High Current	55.1 k	100 Ω @100 MHz	97.8 Ω	6.00 mΩ	8.00 A
74279223560	WE-MPSB	1612		High Current	32.2 k	56.0 Ω @100 MHz	56.1 Ω	4.00 mΩ	10.0 A
7427922808	WE-MPSB	0603		High Current	81.4 k	8.00 Ω @100 MHz	6.32 Ω	2.50 mΩ	9.50 A
74279221100	WE-MPSB	1206		High Current	100 k	10.0 Ω @100 MHz	5.78 Ω	1.00 mΩ	10.5 A

Figure 13: Suitable parts for the output filter

All five parts (see Figure 13) can handle more than 10 000 pulses and have more than 8 A rms current rating, so the final selection will require actual EMC testing to determine which part filters the most noise. The smaller parts are less expensive but provide less reduction of noise.

4.2.4. EMC-Testing of the selected components

For final lab testing we added the above mentioned [WE-MPSB 742 792 245 51](#) to the input and [WE-MPSB 742 792 251 01](#) to the output. You can easily see, that the green output voltage is now already silent.

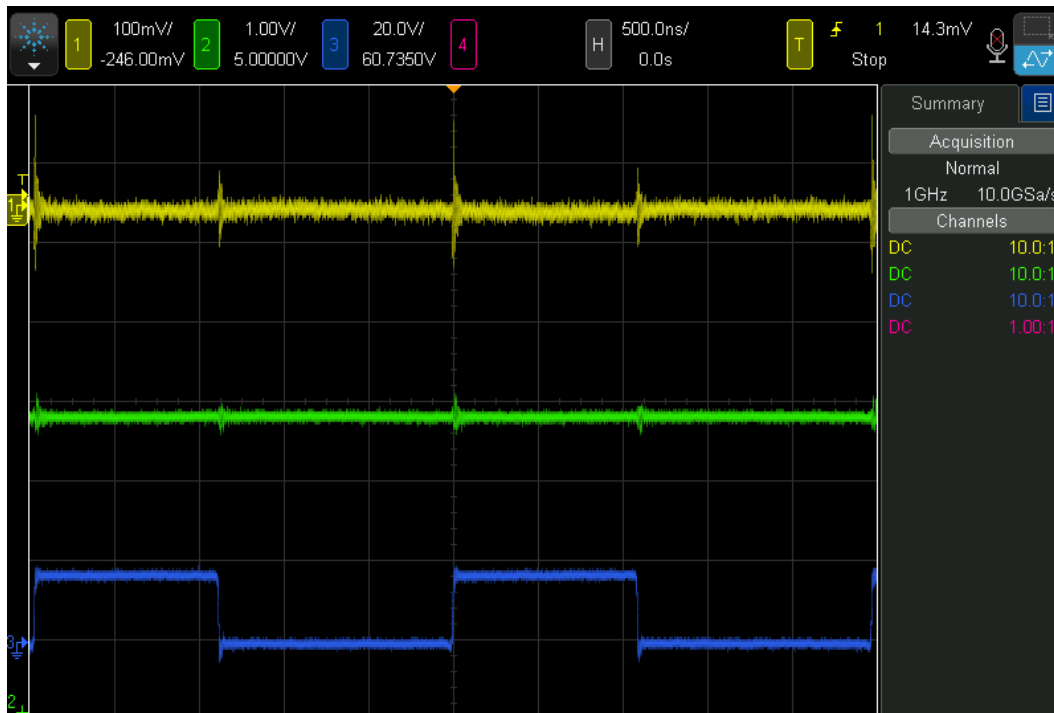

Figure 14: Lab Results of EMC-Testing. The green output voltage is almost silent

APPLICATION NOTE



Peak Current Proof Input Filter with Multilayer Power Suppression Bead WE-MPSB



Figure 15: Comparison of unfiltered and filtered Voltages and its filter effect to PARD noise

Performing radiated EMI scans proves that the chip beads successfully suppress the PARD noise. Especially in the range of the 170 MHz PARD ringing, the EMI is significantly improved.

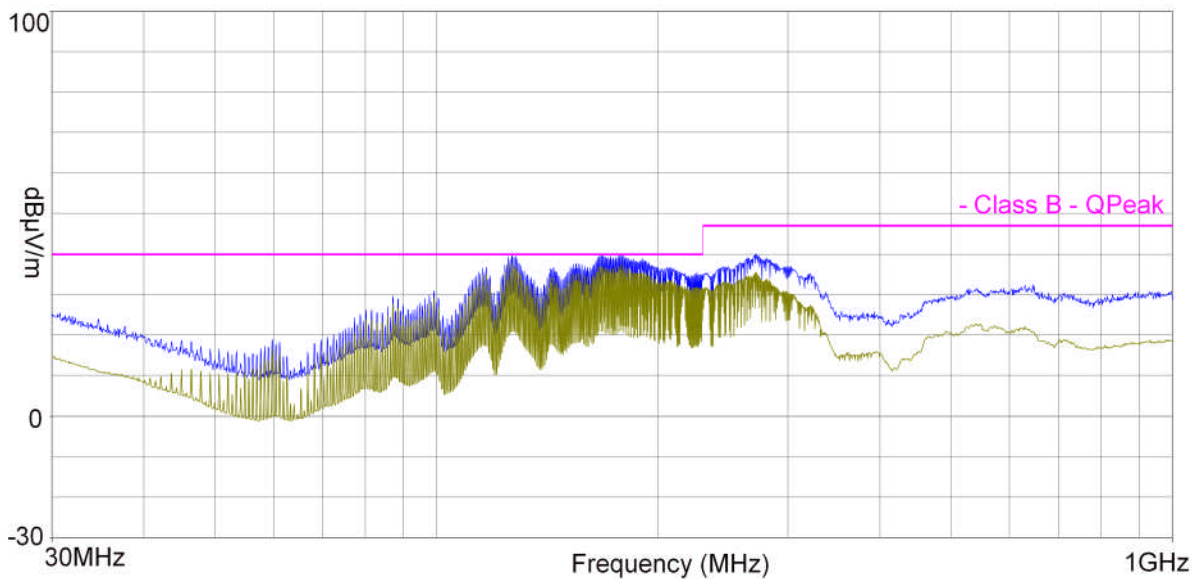

APPLICATION NOTE



Peak Current Proof Input Filter with Multilayer Power Suppression Bead WE-MPSB

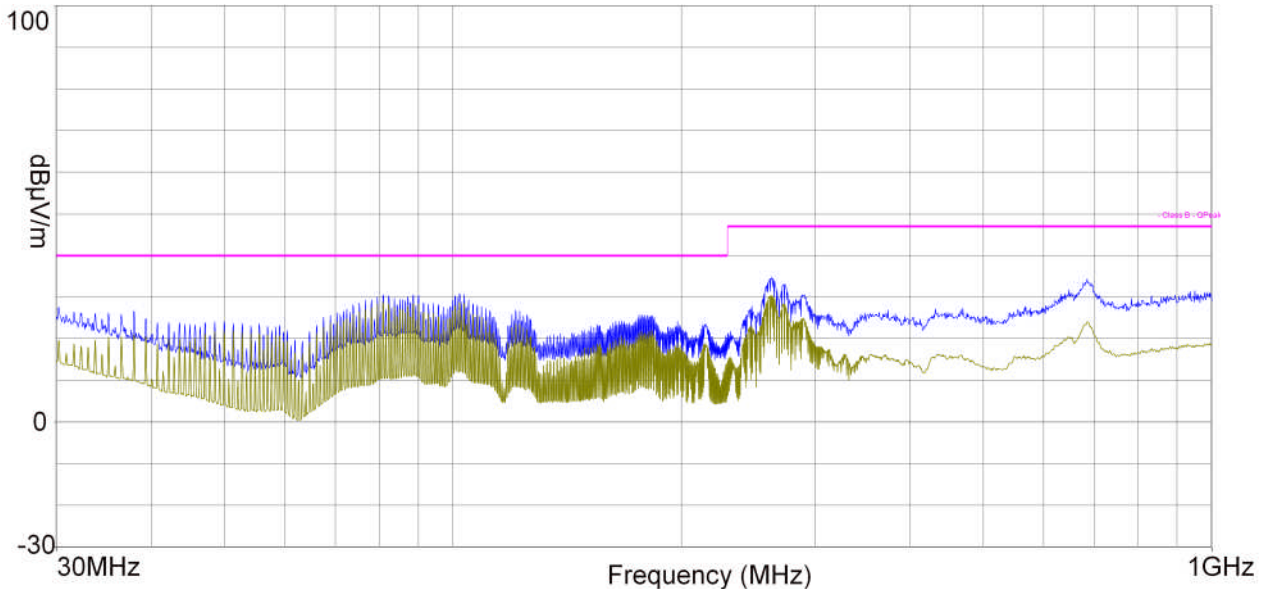

Figure 16: Lab Results of EMC-Testing. The used WE-MPSB chip beads in the measurement below significantly improve the radiated EMI in the range from 100 to 250 MHz, compared to w/o WE-MPSB.

5. Further Considerations

5.1. Influence of R_{DC} to overall efficiency

The used [WE-MPSB 742 792 245 51](#) has a DC resistance of 35 mΩ, which adds additional conduction losses and therewith reduces the efficiency. The measurements in our lab shown just a slight decrease of the efficiency from 95% down to 94.5% for each used chip bead ferrite. To investigate it in detail, we calculate the efficiency as follow:

$$\eta = \frac{P_{out}}{P_{in}} = \frac{V_{out} \cdot I_{out}}{V_{in} \cdot I_{in} + R_{DC} \cdot I_{in}^2} = \frac{5 \text{ V} \cdot 8 \text{ A}}{12 \text{ V} \cdot 3.5 \text{ A} + 35 \text{ m}\Omega \cdot 3.5^2 \text{ A}^2} = 94.3\% \quad \text{EQ.2.}$$

5.2. Influence of DC Bias to Impedance Characteristic

As all magnetic parts, also chip bead ferrites follow the physics principle of elementary magnets. With increasing DC current, they will continuously saturate up to the level of complete saturation. This saturation effect shifts the impedance curve, as shown in Figure 17. The peak inductance value remains almost constant with a drop of just 40% of its initial value, whereas the impedance at lower frequencies significantly drops by rates of up to 90%. In low frequencies the inductive part is dominating, which saturates with DC current. Above the SRF the capacitive part is dominating, which is not effected by the DC current.

However, if you do your EMI measurements at full load current, this (worst case) impedance shift is already considered in your measurements, and you don't have to care about this effect. Important to know is, that the bigger the size of the chip bead ferrites, the lower is the shift of impedance caused by DC current.

APPLICATION NOTE



Peak Current Proof Input Filter with Multilayer Power Suppression Bead WE-MPSB

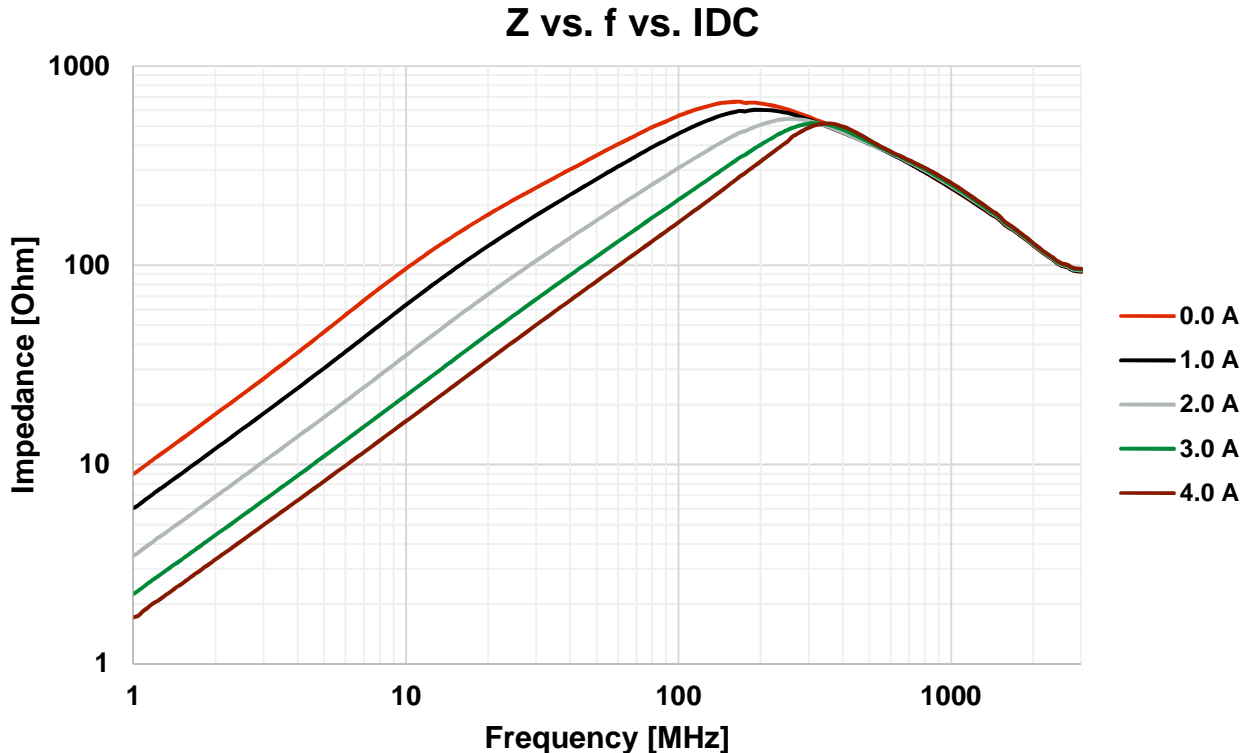

Figure 17: Impedance of [WE-MPSB 742 792 245 51](#) with DC bias current from 0A to 4A

6. Conclusion

Chip bead ferrites are the best components for reducing high frequency noise above 10 MHz. In power supply layouts they must be placed as close as possible to the source of noise which can be the input and output connectors, to properly filter conducted EMI from the input and output wiring harnesses. This prevents conducted EMI from becoming radiated EMI. Being the first components and the last components in the chain exposes chip bead ferrites to heavy transient currents, and circuit designers can now select parts that filter noise with minimal impact to power efficiency and will handle large current pulses with excellent reliability.

7. Bill of Materials

Index	Description	Size	Value	Order Code
	WE-MPSB Multilayer Power Suppression Bead	2220	4 A, 550 Ω	742 792 251 51
	WE-MPSB Multilayer Power Suppression Bead	3312	10 A, 100 Ω	742 792 251 01

APPLICATION NOTE



Use Pulse Stable Chip Bead Ferrites to Suppress EMI and Survive Heavy Transient Currents

IMPORTANT NOTICE

The Application Note is based on our knowledge and experience of typical requirements concerning the areas, serves as general guidance and should not be construed as a commitment for the suitability for customer applications by Würth Elektronik eiSos GmbH & Co. KG. The information in the Application note is subject to change without notice. This document and parts thereof must not be reproduced or copied without written permission, and contents thereof must not be imparted to a third party nor be used for any unauthorized purpose.

Würth Elektronik eiSos GmbH & Co. KG and its subsidiaries and affiliates (WE) are not liable for application assistance of any kind. Customers may use WE's assistance and product recommendations for their applications and design. The responsibility for the applicability and use of WE Products in a particular customer design is always solely within the authority of the customer. Due to this fact it is up to the customer to evaluate, where appropriate to investigate and decide whether the device with the specific product characteristics described in the product specification is valid and suitable for the respective customer application or not.

The technical specifications are stated in the current data sheet of the products. Therefore the customers shall use the data sheets and are cautioned to verify that data sheets are current. The current data sheets can be downloaded at www.we-online.com. Customers shall strictly observe any product-specific notes, cautions and warnings. WE reserve the right to make corrections, modifications, enhancements, improvements, and other changes to its products and services.

WE DOES NOT WARRANT OR REPRESENT THAT ANY LICENSE, EITHER EXPRESS OR IMPLIED, IS GRANTED UNDER ANY PATENT RIGHT, COPYRIGHT, MASK WORK RIGHT, OR OTHER INTELLECTUAL PROPERTY RIGHT RELATING TO ANY COMBINATION, MACHINE, OR PROCESS IN WHICH WE PRODUCTS OR SERVICES ARE USED. INFORMATION PUBLISHED BY WE REGARDING THIRD-PARTY PRODUCTS OR SERVICES DOES NOT CONSTITUTE A LICENSE FROM WE TO USE SUCH PRODUCTS OR SERVICES OR A WARRANTY OR ENDORSEMENT THEREOF.

WE products are not authorized for use in safety-critical applications, or where a failure of the product is reasonably expected to cause severe personal injury or death. Moreover WE products are neither designed nor intended for use in areas such as military, aerospace, aviation, nuclear control, submarine, transportation (automotive control, train control, ship control), transportation signal, disaster prevention, medical, public information network etc. Customers shall inform WE about the intent of such usage before design-in stage. In certain customer applications requiring a very high level of safety and in which the malfunction or failure of an electronic component could endanger human life or health customers must ensure that they have all necessary expertise in the safety and regulatory ramifications of their applications. Customers acknowledge and agree that they are solely responsible for all legal, regulatory and safety-related requirements concerning their products and any use of WE products in such safety-critical applications, notwithstanding any applications-related information or support that may be provided by WE. CUSTOMERS SHALL INDEMNIFY WE AGAINST ANY DAMAGES ARISING OUT OF THE USE OF WE PRODUCTS IN SUCH SAFETY-CRITICAL APPLICATIONS.

USEFUL LINKS

Application Notes:

<http://www.we-online.com/app-notes>

REDEXPERT Design Tool:

<http://www.we-online.com/redexpert>

Toolbox:

<http://www.we-online.com/toolbox>

Product Catalog:

<http://katalog.we-online.de/en/>

CONTACT INFORMATION

Würth Elektronik eiSos GmbH & Co. KG

Max-Eyth-Str. 1, 74638 Waldenburg, Germany

Tel.: +49 (0) 7942 / 945 – 0

Email: appnotes@we-online.de

Web: <http://www.we-online.com>