

Support Note

How to Use Supercapacitors? A Brief Guide to the Design-In Process



SN009 // RENÉ KALBITZ / FRANK PUHANE

1 EDLC – Supercapacitor

Compared to other capacitor technologies, EDLCs (Electric Double Layer Capacitor) are outstanding for their very high charge storage capacity and very low equivalent series resistance (ESR). Their high cycle life, low charging time and their large power output make them the ideal choice for many electric power applications.

Possible applications are:

(Intermediate) storage devices

- To provide an application with power during battery change or power-offline periods
- To provide power in emergency cases as uninterruptible power supplies (UPS)

Hybrid application with battery

- To relieve batteries during high power peak
- To buffer energy fluctuations in order to increase battery life time

The most important parameters for the design-in process are capacitance, discharging and charging time as well as the corresponding voltages. Below we present a summary of the most important formulas and provide examples of calculations.[1,2,3]

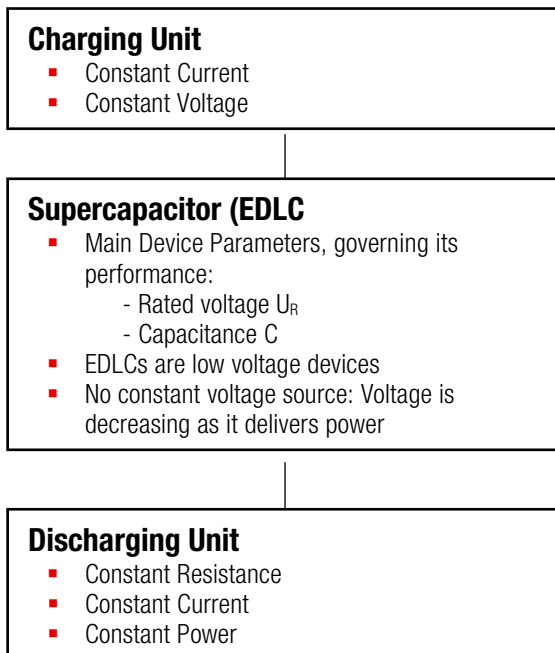

Figure 1: General concept of charging/discharging infrastructure.

2 General Procedure of Design-In

- 1st** Identify the mode of operation for the discharge process:
 - Constant Resistance
 - Constant Current
 - Constant Power
- 2nd** Calculate*) the necessary capacitance depending on desired operation parameter such as operation time, output power and output current.

**)For the sake of simplicity we may neglect the losses due to ESR, leads and connections.*
- 3rd** Identify the suitable charging process:
 - Constant Current
 - Constant Voltage
- 4th** Calculate the charging time depending on the charging current. If necessary calculate the protective resistor.



Figure 2: Radial through-hole EDLC series **WCAP-STSC**

Some important formulas for the design-in process are summarized in the following sections.

Support Note

How to Use Supercapacitors? A Brief Guide to the Design-In Process



3 Parameter and Performance

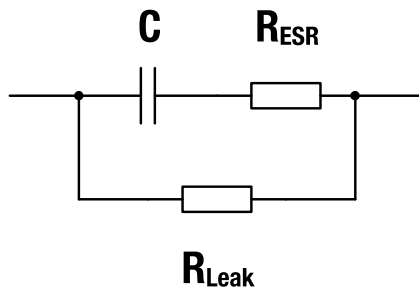

Figure 3: Equivalent Circuit of EDLC

Basic Parameters:

V_R	rated voltage <ul style="list-style-type: none"> Non-Aqueous Electrolyte (typ.) $\approx 2\text{ V} - 3\text{ V}$ given in the datasheet
C	capacitance (given in the datasheet and directly on the capacitors marking)
R_{ESR}	equivalent series resistance (ESR) (given in the datasheet)
R_{Leak}	equivalent parallel resistance, leakage resistance <ul style="list-style-type: none"> corresponding parameter is leakage current I_{Leak}, given in the datasheet relation: $R_{Leak} = \frac{U_R}{I_{Leak}}$ influence on charge storing capabilities $R_{Leak} \approx 10\text{ k}\Omega - 1\text{ M}\Omega$
P	power output, i.e. power consumption of application

Performance Parameters:

V_1 charging voltage, usually $V_R = V_1$

V_2 lower cut-off voltage

energy storage capacity:

$$E = \frac{1}{2} \cdot C \cdot (V_1^2 - V_2^2)$$

$$E = \int P(t) dt = P \cdot t \quad (\text{if } P(t) = \text{const.})$$

maximum power output:

$$P_{\max} = \frac{V_R^2}{4 \cdot R_{ESR}}$$

3.1 Example

An application needs to be driven with a constant power of $P = 0.4\text{ W}$ for $t = 360\text{ s}$. The lower cutoff voltage is $V_2 = 1\text{ V}$. How large is the total amount of energy E and how large is the required capacitance C ?

Calculation:

$$P = 0.4\text{ W for } t = 360\text{ s; } V_1 = V_R = 2.7\text{ V; } V_2 = 1\text{ V}$$

$$E = P \cdot t = 0.4\text{ W} \cdot 360\text{ s} = 144\text{ J} = 0.04\text{ Wh}$$

The required energy is $E = 144\text{ J}$

$$C = 2 \cdot \frac{E}{V_1^2 - V_2^2} = 2 \cdot \frac{144\text{ J}}{(2.7\text{ V})^2 - (1\text{ V})^2} \approx 46\text{ F}$$

The required capacitance is $C = 46\text{ F}$, thus a capacitor with a capacitance of 50 F is recommended.

Support Note

How to Use Supercapacitors? A Brief Guide to the Design-In Process



4 Constant Voltage Charging

For constant voltage charging it is recommended to use a protective resistor in series with the EDLC. It may be necessary to restrict the current with a protective resistor R_P to a specific value I_{max} . For a given I_{max} the resistance is calculated by:

$$R_P = \frac{V_1}{I_{max}} - R_{ESR}$$

The charge characteristic is calculated by ($t_0 = 0$):

$$V = V_1 \cdot \left(1 - e^{-\frac{t}{(R_{ESR} + R_P) \cdot C}} \right)$$

$$I = \frac{U_1}{R_{ESR} + R_P} \cdot e^{-\frac{t}{(R_{ESR} + R_P) \cdot C}}$$

The corresponding charging time is calculated by:

$$t = \ln \left(\frac{V_1}{V_1 - V} \right) \cdot (R_{ESR} + R_P) \cdot C$$

$$t = \ln \left(\frac{100 \%}{100 \% - p} \right) \cdot (R_{ESR} + R_P) \cdot C$$

Charging to 99.9% :

$$t \approx 7 \cdot (R_{ESR} + R_P) \cdot C$$

C	capacitance
V_1	charging voltage
I_0	current at t_0
I_{max}	max. allowable current
V_R	rated voltage
V	voltage at t
t	charging time
t_0	start time
R_P	protective resistance
R_{ESR}	equivalent series resistance
p	charging level in %

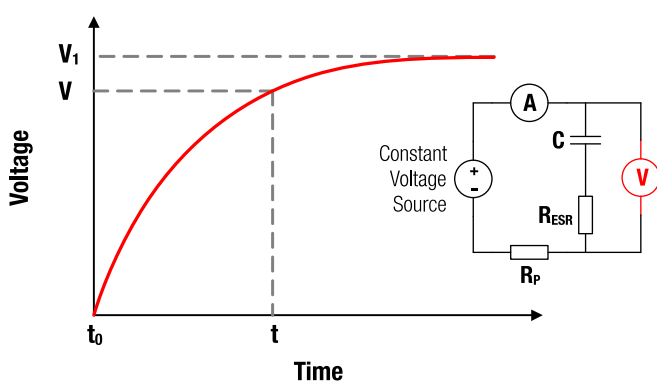

Figure 4: V-t characteristics for constant voltage charging

4.1 Example Protective Resistance

A capacitor with capacitance $C = 50 \text{ F}$ and an equivalent series resistance $R_{ESR} = 0.02 \Omega$ shall be charged with a unprotected power source at $V_1 = V_R = 2.7 \text{ V}$. The power source has a maximal allowable current of $I_{max} = 5 \text{ A}$. How large should the protective resistance be, to prevent overcurrent?

Calculation:

$$I_{max} = 5 \text{ A}; V_R = V_1 = 2.7 \text{ V}; R_{ESR} = 0.02 \Omega$$

$$R_P = \frac{V_1}{I_{max}} - R_{ESR}$$

$$R_P = \frac{2.7 \text{ V}}{5 \text{ A}} - 0.02 \Omega = 0.52 \Omega$$

In order to prevent over current at the power source, a protective resistor with $R_P \geq 0.52 \Omega$ should be used.

4.2 Example Charging Time

A capacitor with capacitance $C = 50 \text{ F}$ is charged to $V = 2.16 \text{ V}$ (80 % of V_R) at constant voltage $V_R = 2.7 \text{ V}$ with a protective resistor $R_P = 0.5 \Omega$ and an equivalent series resistance $R_{ESR} = 0.02 \Omega$. How long is the charging process?

Calculation:

$$C = 50 \text{ F}; V = 2.16 \text{ V}; V_1 = V_R = 2.7 \text{ V}; R_P = 0.5 \Omega; R_{ESR} = 0.02 \Omega$$

$$t = \ln \left(\frac{V_1}{V_1 - V} \right) \cdot (R_{ESR} + R_P) \cdot C$$

$$t = \ln \left(\frac{2.7 \text{ V}}{2.7 \text{ V} - 2.16 \text{ V}} \right) \cdot (0.02 \Omega + 0.5 \Omega) \cdot 50 \text{ F} \approx 42 \text{ s}$$

The charging time is $\approx 42 \text{ s}$.

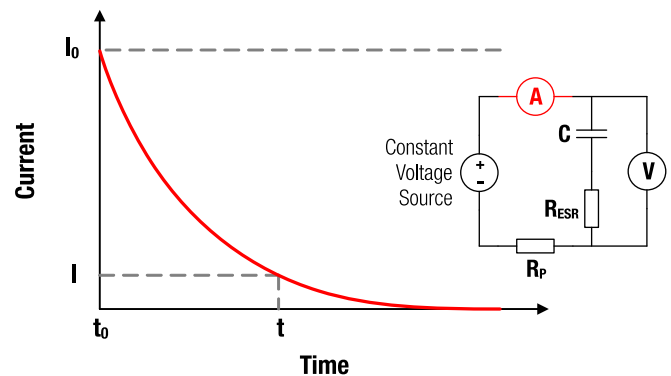

Figure 5: I-t characteristics for constant voltage charging

Support Note

How to Use Supercapacitors? A Brief Guide to the Design-In Process



5 Constant Resistance Discharging

The discharging characteristics of a capacitor with capacitance C over given load resistance R_L is calculated by ($t_0=0$):

$$V = V_0 \cdot e^{-\frac{t}{(R_{ESR} + R_L) \cdot C}}$$

$$|I| = \frac{V_0}{R_{ESR} + R_L} \cdot e^{-\frac{t}{(R_{ESR} + R_L) \cdot C}}$$

The corresponding discharging time is calculated by:

$$t = \ln\left(\frac{V_0}{V}\right) \cdot (R_{ESR} + R_L) \cdot C$$

The necessary capacitance is calculated with:

$$C = \frac{t}{\ln\left(\frac{V_0}{V}\right) \cdot (R_{ESR} + R_L)}$$

C	capacitance
V_0	charging voltage at t_0
I_0	current at t_0
V_R	rated voltage
V	voltage at t
t	discharging time
t_0	start time
R_L	load resistance
R_{ESR}	equivalent series resistance

5.1 Example Discharging Time

A capacitor with capacitance $C = 50 \text{ F}$ is discharged from its rated voltage $V_R = 2.7 \text{ V}$ to $V = 0.3 \text{ V}$ with a load of $R_L = 1 \text{ } \Omega$. How long is the discharging process?

Calculation:

$$R_{ESR} = 0.02 \text{ } \Omega; R_L = 1 \text{ } \Omega; C = 50 \text{ F}; V_0 = V_R = 2.7 \text{ V}; V = 0.3 \text{ V}$$

$$t = \ln\left(\frac{V_0}{V}\right) \cdot (R_{ESR} + R_L) \cdot C$$

$$t = \ln\left(\frac{2.7 \text{ V}}{0.3 \text{ V}}\right) \cdot (0.02 \text{ } \Omega + 1 \text{ } \Omega) \cdot 50 \text{ F} \approx 112 \text{ s}$$

The discharge time is approximately 112 seconds.

5.2 Example Voltage Drop

A capacitor with a capacitance $C = 50 \text{ F}$ is discharged from its rated voltage $V_R = 2.7 \text{ V}$ with a load of $R_L = 2 \text{ } \Omega$ for a period of time $t = 280 \text{ s}$. What is the remaining voltage?

Calculation:

$$R_{ESR} = 0.02 \text{ } \Omega; R_L = 2 \text{ } \Omega; C = 50 \text{ F}; V_0 = V_R = 2.7 \text{ V}; t = 280 \text{ s}$$

$$V = V_0 \cdot e^{-\frac{t}{(R_{ESR} + R_L) \cdot C}} = 2.7 \text{ V} \cdot e^{-\frac{280 \text{ sec}}{(0.02 \text{ } \Omega + 2 \text{ } \Omega) \cdot 50 \text{ F}}} = 0.17 \text{ V}$$

The remaining voltage is $V = 0.17 \text{ V}$.

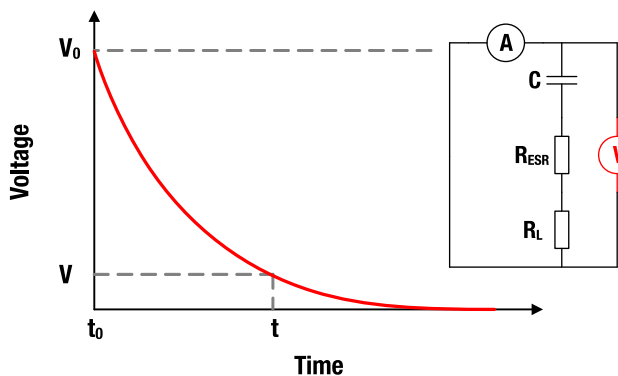

Figure 6: V-t characteristics for constant resistance discharging

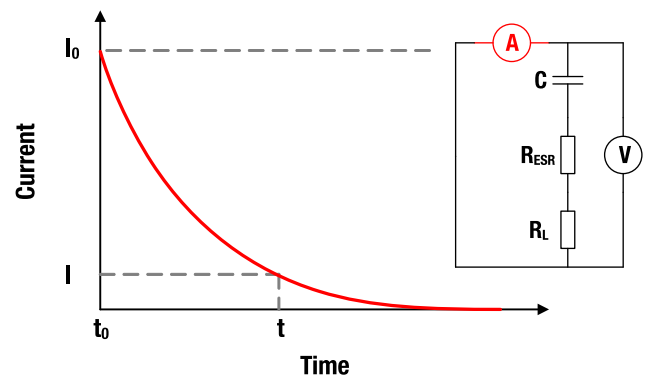

Figure 7: I-t characteristics for constant resistance discharging

Support Note

How to Use Supercapacitors? A Brief Guide to the Design-In Process



6 Constant Current Charging/Discharging

If a constant current is used, the voltage V at the terminals for time t ($t = 0$) is calculated by:

$$V - V_0 = \frac{I_C}{C} \cdot t$$

The corresponding discharge time ($t_0 = 0$) is calculated by:

$$t = (V_0 - V) \cdot \frac{C}{I_D}$$

The corresponding charging time ($t_0 = 0$) is calculated by:

$$t = (V - V_0) \cdot \frac{C}{I_C}$$

The necessary capacitance is calculated with:

$$C = \frac{t \cdot I_D}{(V_0 - V)}$$

$I_{C,D}$	constant charge / discharge current
C	capacitance
V_R	rated voltage
V, I	voltage, current at t
V_0	voltage at t_0 (charging)
$ t - t_0 $	(dis)charge time
t_0	start time
R_{ESR}	equivalent series resistance

6.1 Example Charging Time

A capacitor with capacitance $C = 50 \text{ F}$ is charged from $V_0 = 0.3 \text{ V}$ to its rated voltage $V_R = 2.7 \text{ V}$ with a constant current $I_C = 2 \text{ A}$. How long is the charging process?

Calculation:

$$I_C = 2 \text{ A}; C = 50 \text{ F}; V = V_R = 2.7 \text{ V}; V_0 = 0.3 \text{ V}$$

$$t = (V - V_0) \cdot \frac{C}{I_C} = (2.7 \text{ V} - 0.3 \text{ V}) \cdot \frac{50 \text{ F}}{2 \text{ A}} = 60 \text{ s}$$

The charge time is 60 seconds.

6.2 Example Voltage Increase

A capacitor with capacitance $C = 50 \text{ F}$ and an initial voltage $V_0 = 0.3 \text{ V}$ is charged with a constant current $I_C = 2 \text{ A}$ for $t = 5 \text{ s}$. How large is the capacitor voltage?

Calculation:

$$I_C = 2 \text{ A}; C = 50 \text{ F}; V_0 = 0.3 \text{ V}; t = 5 \text{ s}$$

$$V = V_0 + \frac{I_C}{C} \cdot t = 0.3 \text{ V} + \frac{2 \text{ A}}{50 \text{ F}} \cdot 5 \text{ s} = 0.5 \text{ V}$$

The capacitor voltage is $V = 0.5 \text{ V}$.

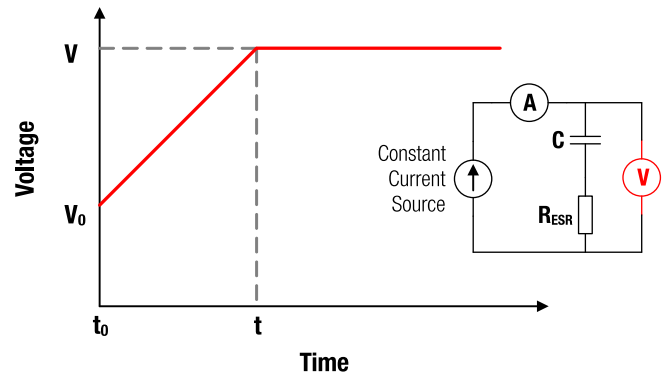

Figure 8: V-t characteristics for constant current charging.

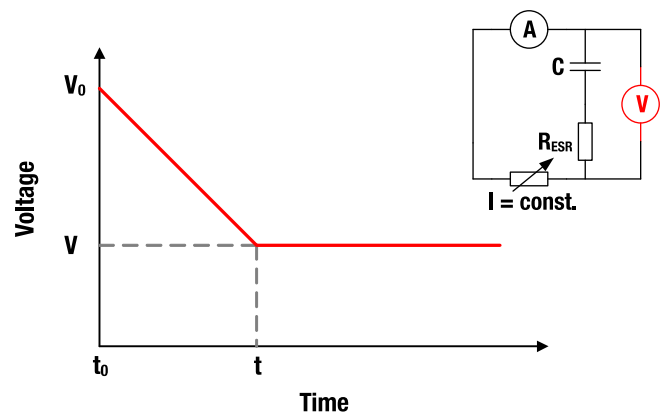

Figure 9: V-t characteristics for constant current discharging.

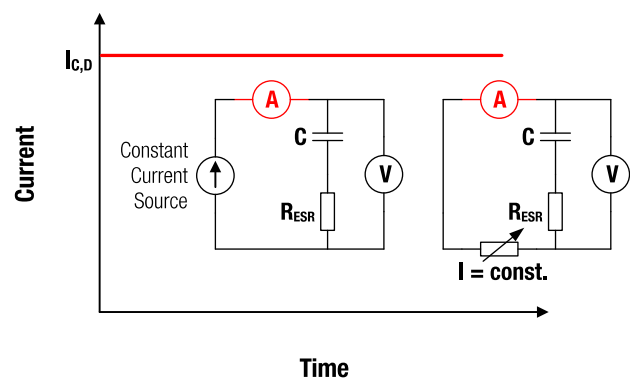

Figure 10: I-t characteristics for constant current charging and discharging.

Support Note

How to Use Supercapacitors? A Brief Guide to the Design-In Process



7 Constant Power Discharging

If the capacitor is discharged at a constant power P_C , the voltage and current characteristic are calculated by ($t_0 = 0$):

$$V_0^2 - V^2 = \frac{2 \cdot P_C}{C} \cdot t$$

$$|I| = \left(\frac{V_0^2}{P_C^2} - \frac{2}{C \cdot P_C} \cdot t \right)^{\frac{1}{2}}$$

The corresponding discharge time ($t_0 = 0$) is calculated by:

$$t = (V_0^2 - V^2) \frac{C}{2 \cdot P_C}$$

The necessary capacitance is calculated with:

$$C = \frac{2 \cdot t \cdot P_C}{V_0^2 - V^2}$$

P_C	constant power output
C	capacitance
V_R	rated voltage
V, I	voltage, current at t
I_0	current at t_0
V_0	voltage at t_0 (charging)
$t - t_0$	discharge time
t_0	start time

7.1 Example Discharge Time

A capacitor with capacitance $C = 50 \text{ F}$ and rated voltage $V_R = 2.7 \text{ V}$ is discharged at constant power $P_C = 0.2 \text{ W}$. The cut-off voltage is $V = 0.7 \text{ V}$. How long can the capacitor be operated under this condition?

Calculation:

$$P_C = 0.2 \text{ W}; C = 50 \text{ F}; V_0 = V_R = 2.7 \text{ V}; V = 0.7 \text{ V}$$

$$t = (V_0^2 - V^2) \frac{C}{2 \cdot P_C}$$

$$t = ((2.7 \text{ V})^2 - (0.7 \text{ V})^2) \cdot \frac{50 \text{ F}}{2 \cdot 0.2 \text{ W}} = 850 \text{ s}$$

It can be operated for $t = 850 \text{ s}$.

7.2 Example Voltage Drop

A fully charged capacitor with capacitance $C = 50 \text{ F}$ and rated voltage $V_R = 2.7 \text{ V}$ has been operated for $t = 180 \text{ s}$ at constant power output of $P_C = 0.7 \text{ W}$. How large is the remaining voltage?

Calculation:

$$P_C = 0.7 \text{ W}; C = 50 \text{ F}; V_0 = V_R = 2.7 \text{ V}; t = 180 \text{ s}; t_0 = 0 \text{ s}$$

$$V = \sqrt{V_0^2 - \frac{2 \cdot P_C}{C} \cdot t}$$

$$V = \sqrt{(2.7 \text{ V})^2 - \frac{2 \cdot 0.7 \text{ W}}{50 \text{ F}} \cdot 180 \text{ s}} = 1.5 \text{ V}$$

The remaining voltage is $V = 1.5 \text{ V}$

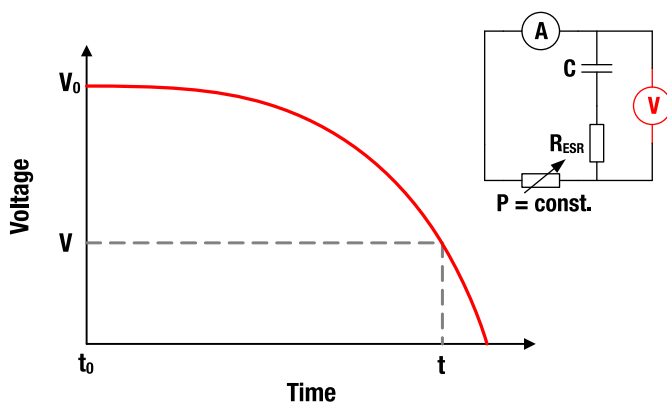

Figure 11: V-t characteristics for constant power discharging

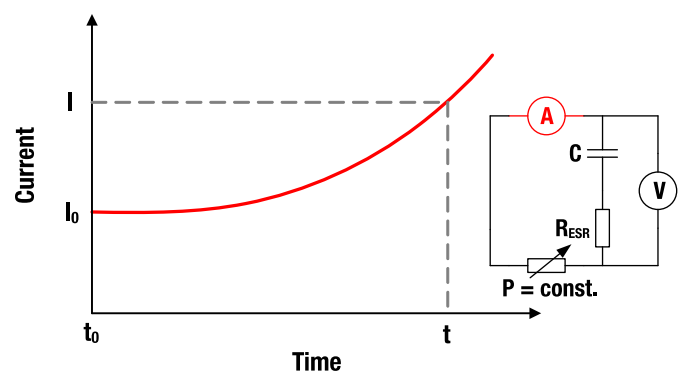

Figure 12: I-t characteristics for constant power discharging

Support Note

How to Use Supercapacitors? A Brief Guide to the Design-In Process



A. Appendix

A.1. References

- [1] N. Kularatna (2015). *Energy Storage Devices for Electronic Systems – Rechargeable Batteries and Supercapacitors*. Elsevier Academic Press (Print Book)
- [2] F. Beguin, E. Frackowiak, G. Q. M. Lu (eds.) (2013). *Supercapacitors - Materials, Systems, and Applications*. Wiley-VCH (Print Book)
- [3] B. E. Conway (1999). *Electrochemical Supercapacitors – Scientific Fundamentals and Technological Applications*. Kluwer Academics / Plenum Publishers, New York (Print book)

Support Note

How to Use Supercapacitors? A Brief Guide to the Design-In Process



IMPORTANT NOTICE

The Application Note is based on our knowledge and experience of typical requirements concerning these areas. It serves as general guidance and should not be construed as a commitment for the suitability for customer applications by Würth Elektronik eiSos GmbH & Co. KG. The information in the Application Note is subject to change without notice. This document and parts thereof must not be reproduced or copied without written permission, and contents thereof must not be imparted to a third party nor be used for any unauthorized purpose.

Würth Elektronik eiSos GmbH & Co. KG and its subsidiaries and affiliates (WE) are not liable for application assistance of any kind. Customers may use WE's assistance and product recommendations for their applications and design. The responsibility for the applicability and use of WE Products in a particular customer design is always solely within the authority of the customer. Due to this fact it is up to the customer to evaluate and investigate, where appropriate, and decide whether the device with the specific product characteristics described in the product specification is valid and suitable for the respective customer application or not.

The technical specifications are stated in the current data sheet of the products. Therefore the customers shall use the data sheets and are cautioned to verify that data sheets are current. The current data sheets can be downloaded at www.we-online.com. Customers shall strictly observe any product-specific notes, cautions and warnings. WE reserves the right to make corrections, modifications, enhancements, improvements, and other changes to its products and services.

WE DOES NOT WARRANT OR REPRESENT THAT ANY LICENSE, EITHER EXPRESS OR IMPLIED, IS GRANTED UNDER ANY PATENT RIGHT,

COPYRIGHT, MASK WORK RIGHT, OR OTHER INTELLECTUAL PROPERTY RIGHT RELATING TO ANY COMBINATION, MACHINE, OR PROCESS IN WHICH WE PRODUCTS OR SERVICES ARE USED. INFORMATION PUBLISHED BY WE REGARDING THIRD-PARTY PRODUCTS OR SERVICES DOES NOT CONSTITUTE A LICENSE FROM WE TO USE SUCH PRODUCTS OR SERVICES OR A WARRANTY OR ENDORSEMENT THEREOF.

WE products are not authorized for use in safety-critical applications, or where a failure of the product is reasonably expected to cause severe personal injury or death. Moreover, WE products are neither designed nor intended for use in areas such as military, aerospace, aviation, nuclear control, submarine, transportation (automotive control, train control, ship control), transportation signal, disaster prevention, medical, public information network etc. Customers shall inform WE about the intent of such usage before design-in stage. In certain customer applications requiring a very high level of safety and in which the malfunction or failure of an electronic component could endanger human life or health, customers must ensure that they have all necessary expertise in the safety and regulatory ramifications of their applications. Customers acknowledge and agree that they are solely responsible for all legal, regulatory and safety-related requirements concerning their products and any use of WE products in such safety-critical applications, notwithstanding any applications-related information or support that may be provided by WE.

CUSTOMERS SHALL INDEMNIFY WE AGAINST ANY DAMAGES ARISING OUT OF THE USE OF WE PRODUCTS IN SUCH SAFETY-CRITICAL APPLICATIONS.

USEFUL LINKS



Application Notes

www.we-online.com/app-notes



REDEXPERT Design Tool

www.we-online.com/redexpert



Toolbox

www.we-online.com/toolbox



Product Catalog

www.we-online.com/products

CONTACT INFORMATION

appnotes@we-online.com

Tel. +49 7942 945 - 0



Würth Elektronik eiSos GmbH & Co. KG
Max-Eyth-Str. 1 · 74638 Waldenburg · Germany

www.we-online.com

