

ICCS – Intelligent Control and Command Systems

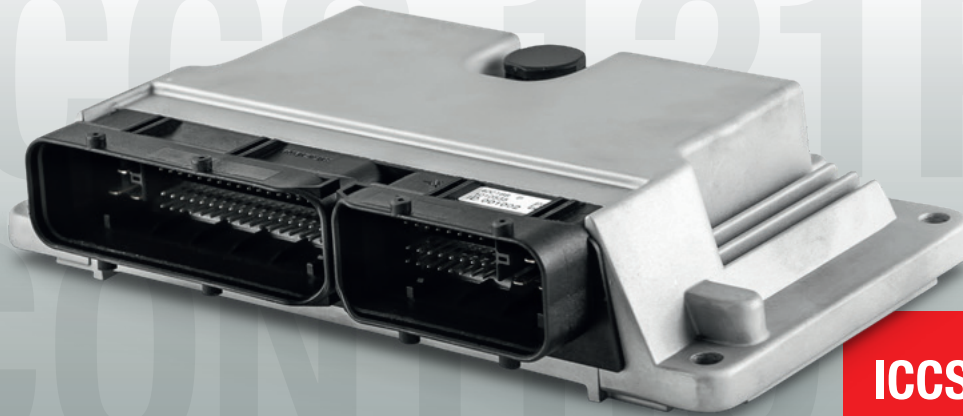

ICCS 121P CAN Controller

ICCS 121P CAN Controller is a part of the Intelligent Control and Command Systems (ICCS) product range, which can be easily implemented in your CAN network, or used as a standalone module. The 16 bit processor NXP HCS12XEQ with an integrated co-processor has sufficient computing power to handle complex tasks. The two CAN and an optional LIN master interfaces allow the data exchange between independent bus systems or enable gateway / filter functions.

Applications

- Transmission of sensor values to the CAN bus
- CAN to CAN gateway function
- LIN to CAN gateway function
- Direct supply of loads up to 2 A
- Interface between switches and CAN bus
- Lighting system handling
- Protected power splices with built-in poly fuses

GENERAL INFORMATION

Housing	Metal housing
Connector	1 x 81 pins, 1 x 40 pins
Dimensions	95.1 x 179 x 39.3 mm
Weight	~530 g
Operating temperature	-30 °C to 70 °C
Storage temperature	-30 °C to 70 °C
Ingress protection	IP65
Operating voltage	9-30 V (with limitation on 12 V LIN bus)
Pre-fusing	10 A / Power entry
Current consumption	50 mA
Processor type	NXP HCS12XEQ
Clock frequency	100 MHz
Flash memory	384 kB
RAM	24 kB
EEPROM	1 kB available for graphical programming
E1 certification	ECE10 Rev.05 : 058257

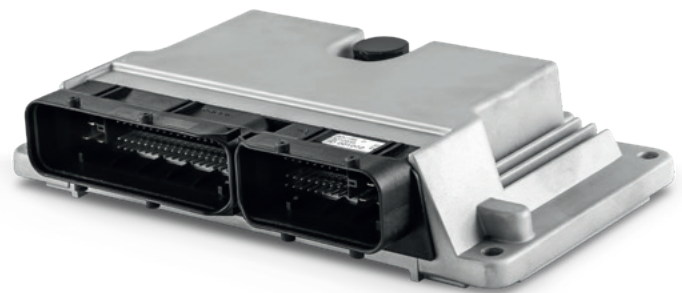

CAN BUS

acc. ISO 11898-2	High speed
acc. CAN 2.0 B	29 Bits extended address identifier
acc. CAN 2.0 A	11 Bits address identifier
Baud rate	20 kBit/s to 1000 kBit/s (125 kBit/s default value)

LIN BUS

LIN 2.1 master	Pull-up to Vsupply, 1 k Ω & diode
Baud rate	4800 to 115200 bps
Vsupply	Recommended max 12 V (1 k Ω -12 V LIN)

INPUTS / OUTPUTS OVERVIEW

4	Analogue inputs	0-10 V DC / 0-20mA
3	Analogue inputs	0-10 V DC
3	Analogue inputs	0-30 V DC
3	Analogue inputs	0-5 V DC
4	Frequency inputs	Switch on / switch off level : see Inputs / outputs details
16	Digital inputs	Switch on/switch off level : see Inputs / outputs details
16	Digital outputs	Low side outputs max 300 mA / channel
16	Digital outputs	High side outputs max 2 A / channel

ICCS 121P CAN Controller



INPUTS / OUTPUTS DETAILS	
Analogue inputs	4 x 0-10 V DC / 0-20 mA
Voltage / current	0-11.4 V DC / 0-23 mA
Resolution	12 bits
Input resistance	22.6 kΩ
Pull-down resistance	Switchable 0.5 kΩ in 0-20 mA mode (4x)
Analogue inputs	3 x 0-10 V DC
Input voltage	0-11.4 V DC
Resolution	12 bits
Input resistance	22.6 kΩ
Analogue inputs	3 x 0-5 V DC
Input voltage	0-5 V DC
Resolution	12 bits
Input resistance	61.6 kΩ
Analogue inputs	3 x 0-30 V DC
Input voltage	0-33.6 V DC
Resolution	12 bits
Input resistance	66.6 kΩ

INPUTS / OUTPUTS DETAILS	
Frequency inputs	4
Input resistance	100 kΩ
Input frequency	5 kHz (max)
Switch-on level	3 V DC
Switch-off level	2 V DC
Digital inputs	16
Input voltage	0 V DC to Vsupply
Switch-on level	7 V DC
Switch-off level	5 V DC
Input resistance	22.6 kΩ
Digital outputs	16 x Low Side
Load current	300 mA
Digital outputs	16 x High Side
Load current	max 2 A Diagnostic current sense, freewheel diode
PWM outputs	8 of 16 digital outputs
PWM frequency	max 1 kHz
Duty cycle	0 to 100 %
Resolution	0.10 %
Load current	max 1 A

Hardware Map

9	SPLICE1_1	Splice 1 0 Ω bridges 3 A max
10	SPLICE1_2	
11	SPLICE1_3	
12	SPLICE1_4	
8	SPLICE2_1	Splice 2 0 Ω bridges 3 A max
7	SPLICE2_2	
6	SPLICE2_3	
25	SPLICE2_4	
105	SPLICE3	ANA9
113	SPLICE3	
114	SPLICE3	
117	SPLICE3	
30	RPM_A0	Frequency Input
31	RPM_A1	
32	RPM_B0	
33	RPM_B1	
36	ANA0	Analogue Input ANAS Lowest Level
37	ANA1	
38	ANA2	
68	ANA3	
49	ANA4	
48	ANA5	
107	ANA_U_I_10	
106	ANA_U_I_11	
98	ANA_U_I_12	
99	ANA_U_I_13	
29	DIO	Digital Input DIO Lowest Level
34	DI1	
35	DI2	
75	DI4	
85	DI5	
93	DI6	
102	DI7	
103	DI8	
104	DI8	
112	DI9	
76	DI10	
41	DI11	
101	DI12	
100	DI13	
42	DI14	
91	CAN0_Term_H	Bridge to activate 120Ω res. on CAN0
83	CAN0_Term_L	
65	CAN0_H	CAN bus 0
66	CAN0_L	
84	CAN0_L	
44	CAN1_H	
90	CAN1_H	
45	CAN1_L	
82	CAN1_L	Bridge to activate 120Ω res. on CAN1
47	CAN1_Term_H	
46	CAN1_Term_L	
70	LIN Bus	LIN master

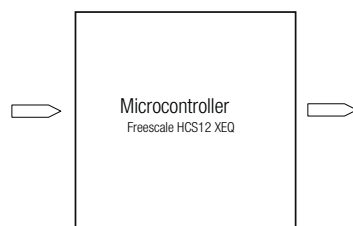
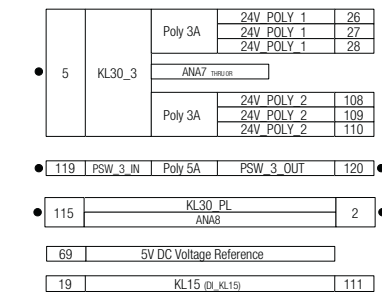

FLASH	384 kB
RAM	24 kB
EEPROM	1 kB*

*EEPROM available for graphical programming

Ground	
AGND	3
	67
	71
	72
	79
	80
	87
	88
	116
	118

● JPT power pin

High side Power Supply	
KL30_1 (0-3)	1
KL30_2 (4-11)	4
KL30_4 (12-15)	121

Digital Output		
High side 2A max / output With current sense PWM Output 0 to 7	OUTPUT0	62
	OUTPUT1	81
	OUTPUT2	60
	OUTPUT3	59
		78
	OUTPUT4	58
		77
	OUTPUT5	57
	OUTPUT6	56
	OUTPUT7	55
		74
	OUTPUT8	54
	OUTPUT9	73
	OUTPUT10	53
	OUTPUT11	52
	50	
OUTPUT12	51	
	86	
OUTPUT13	94	
OUTPUT14	95	
OUTPUT15	96	
	89	
	97	

Digital Output		
Low side 300mA	OUTPUT0	14
	OUTPUT1	64
	OUTPUT2	13
	OUTPUT3	15
	OUTPUT4	16
	OUTPUT5	18
	OUTPUT6	17
	OUTPUT7	40
	OUTPUT8	21
	OUTPUT9	20
	OUTPUT10	22
	OUTPUT11	39
	OUTPUT12	23
	OUTPUT13	43
	OUTPUT14	63
OUTPUT15	24	

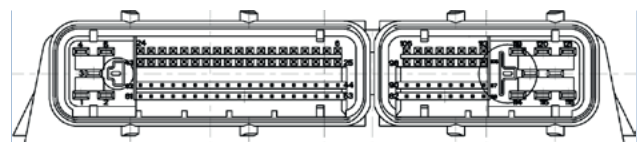



ICCS

121P CAN Controller

PIN ASSIGNMENT FOR 81 PINS CONNECTOR

Pin	Description	Function
1	KL30_1	Power supply for outputs 0-3
2	KL30_PL	Internal link between two pins (115-2) measured from ANA_8 0-30 V
3	GND	Ground, all ground pins are interconnected
4	KL30_2	Power supply for outputs 4-11
5	KL30_3	Power supply input for polyfuse / ANA in 7 0-30 V
6	splice 2	Signal distribution 0 Ω all splice 2
7	splice 2	Signal distribution 0 Ω all splice 2
8	splice 2	Signal distribution 0 Ω all splice 2
9	splice 1	Signal distribution 0 Ω all splice 1
10	splice 1	Signal distribution 0 Ω all splice 1
11	splice 1	Signal distribution 0 Ω all splice 1
12	splice 1	Signal distribution 0 Ω all splice 1
13	LSD output 2	LSD output 300 mA
14	LSD output 0	LSD output 300 mA
15	LSD output 3	LSD output 300 mA
16	LSD output 4	LSD output 300 mA
17	LSD output 6	LSD output 300 mA
18	LSD output 5	LSD output 300 mA
19	KL15	Wake up / ignition - internally bridged to 111
20	LSD output 9	LSD output 300 mA
21	LSD output 8	LSD output 300 mA
22	LSD output 10	LSD output 300 mA
23	LSD output 12	LSD output 300 mA
24	LSD output 15	LSD output 300 mA
25	splice 2	Signal distribution 0 Ω all splice 2
26	Power supply poly	3 A polyfuse output (shared between pin 26, 27, 28) supplied by KL30_3
27		
28		
29	DI_0	Digital input
30	Freq_A0	Frequency input / digital encoder
31	Freq_A1	Frequency input / digital encoder
32	Freq_B0	Frequency input / digital encoder
33	Freq_B1	Frequency input / digital encoder
34	DI_1	Digital input
35	DI_2	Digital input
36	ANA_0	Analogue input 0-10 V
37	ANA_1	Analogue input 0-10 V
38	ANA_2	Analogue input 0-10 V
39	DI_16 / LSD output 11	Digital input shared with a low side output
40	DI_15 / LSD output 7	Digital input shared with a low side output
41	DI_14	Digital input
42	DI_11	Digital input
43	LSD output 13	LSD output 300 mA
44	CAN1 H	CAN 1 H also available on pin 90
45	CAN1 L	CAN 1 L also available on pin 82
46	CAN1 term L	Wire bridge to CAN1 term H to link a 120 Ω resistor
47	CAN1 term H	Wire bridge to CAN1 term L to link a 120 Ω resistor
48	ANA_5	Analogue input 0-5 V
49	ANA_4	Analogue input 0-5 V
50	HSD output 11	Digital output 2 A HSD shared with pin 51
51	HSD output 11	Digital output 2 A HSD shared with pin 50
52	HSD output 10	Digital output 2 A HSD
53	HSD output 9	Digital output 2 A HSD
54	HSD output 8	Digital output 2 A HSD shared with pin 73
55	HSD output 7	Digital output 2 A HSD shared with pin 74 (PWM)

PIN ASSIGNMENT FOR 81 PINS CONNECTOR

Pin	Description	Function
56	HSD output 6	Digital output 2 A HSD (PWM)
57	HSD output 5	Digital output 2 A HSD (PWM)
58	HSD output 4	Digital output 2 A HSD shared with pin 77 (PWM)
59	HSD output 3	Digital output 2 A HSD shared with pin 78 (PWM)
60	HSD output 2	Digital output 2 A HSD (PWM)
61	HSD output 1	Digital output 2 A HSD (PWM)
62	HSD output 0	Digital output 2 A HSD shared with pin 81 (PWM)
63	LSD output 14	LSD output 300 mA
64	LSD output 1	LSD output 300 mA
65	CANO H	CAN 0 H also available on pin 92
66	CANO L	CAN 0 L also available on pin 84
67	GND	Ground, all ground pins are interconnected
68	ANA_3	Analogue input 0-5 V
69	5V Vref	Switchable 5 V reference approx. 400 mA
70	LIN bus	LIN master type shared with DL_17
71	GND	Ground, all ground pins are interconnected
72	GND	Ground, all ground pins are interconnected
73	HSD output 8	Digital output 2 A HSD shared with pin 54
74	HSD output 7	Digital output 2 A HSD shared with pin 55 (PWM)
75	DI_4	Digital input distribution to pin 85
76	DI_10	Digital input
77	HSD output 4	Digital output 2 A HSD shared with pin 58 (PWM)
78	HSD output 3	Digital output 2 A HSD shared with pin 59 (PWM)
79	GND	Ground, all ground pins are interconnected
80	GND	Ground, all ground pins are interconnected
81	HSD output 0	Digital output 2 A HSD shared with pin 62 (PWM)

- DI_3 and ANA6 do not exist in the design.
- Each analogue input is also usable as a digital input in the programming software.
- All digital outputs HSD are equipped with freewheel diodes.



ICCS 121P CAN Controller

PIN ASSIGNMENT FOR 40 PINS CONNECTOR

Pin	Description	Function
82	CAN1 L	CAN 1 L also available on pin 44
83	CAN0 term L	Wire bridge to CAN0 term H to link a 120 Ω resistor
84	CAN0 L	CAN 0 L also available on pin 66
85	DI_4	Digital input distribution to pin 75
86	HSD output 12	Digital output 2 A HSD shared with pin 94
87	GND	Ground, all ground pins are interconnected
88	GND	Ground, all ground pins are interconnected
89	HSD output 15	Digital output 2 A HSD shared with pin 97
90	CAN1 H	CAN 1 H also available on pin 44
91	CAN0 term H	Wire bridge to CAN0 term L to link a 120 Ω resistor
92	CAN0 H	CAN 0 H also available on pin 65
93	DI_5	Digital input
94	HSD output 12	Digital output 2A HSD shared with pin 86
95	HSD output 13	Digital output 2 A HSD
96	HSD output 14	Digital output 2 A HSD
97	HSD output 15	Digital output 2 A HSD shared with pin 89
98	ANA_U_I_12	ANA in 0-10 V / 0-20 mA
99	ANA_U_I_13	ANA in 0-10 V / 0-20 mA
100	DI_13	Digital input
101	DI_12	Digital input

PIN ASSIGNMENT FOR 40 PINS CONNECTOR

Pin	Description	Function
102	DI_6	Digital input
103	DI_7	Digital input
104	DI_8	Digital input
105	splice 3	Hardwired signal distribution connected to ANA in 9 0-30 V
106	ANA_U_I_11	ANA in 0-10 V / 0-20 mA
107	ANA_U_I_10	ANA in 0-10 V / 0-20 mA
108	Power supply poly	3 A polyfuse output (shared between pin 108,109,110) supplied by KL30_3
109		
110		
111	KL15	Wake up / ignition - internally bridged to 19
112	DI_9	Digital input
113	splice 3	Hardwired signal distribution connected to ANA in 9 0-30 V
114	splice 3	Hardwired signal distribution connected to ANA in 9 0-30 V
115	KL30_PL	Internal link between two pins (115-2) measured from ANA_8 0-30 V
116	GND	Ground, all ground pins are interconnected
117	splice 3	Hardwired signal distribution connected to ANA in 9 0-30 V
118	GND	Ground, all ground pins are interconnected
119	Power supply poly in	5 A polyfuse protected line 119-120
120	Power supply poly out	5 A polyfuse protected line 119-120
121	KL30_4	Power supply for output 12-15

Power supply distribution - Schematic

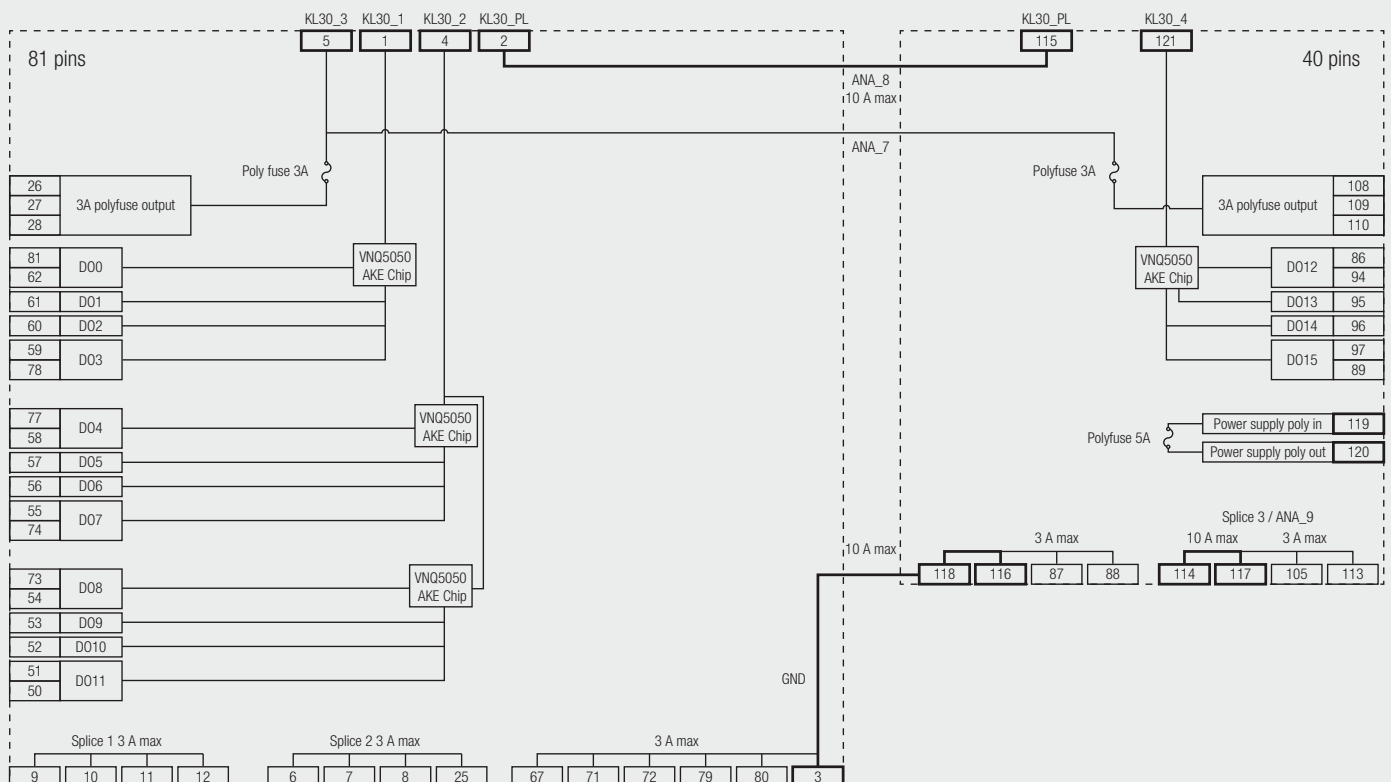

ICCS 121P CAN Controller

Dimensions

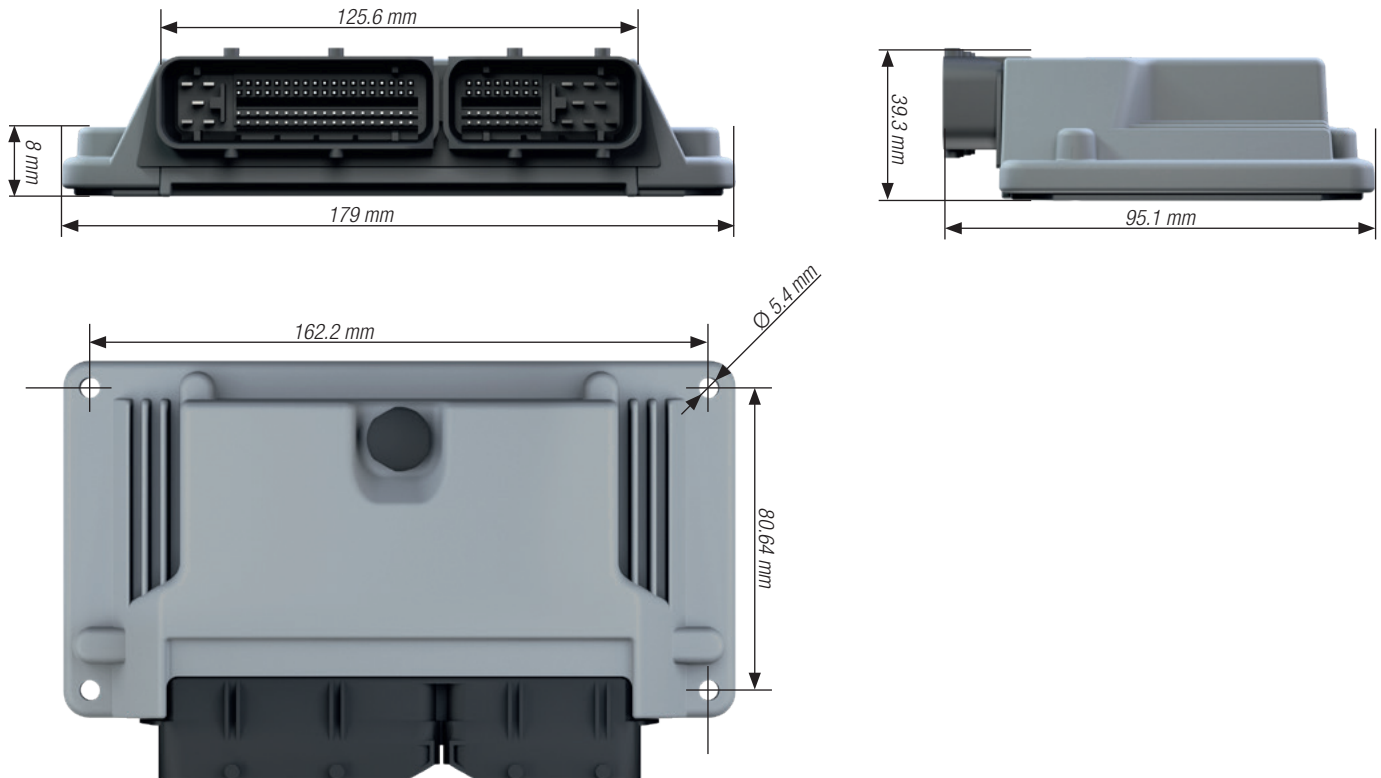

Order information

AVAILABLE REFERENCE	PART NUMBER WE ICS
ICCS 121P XEQ	ICS-103362

MATING CONNECTOR 40 PINS	PART NUMBER TYCO
Crimp contact MQS 0.50-0.75 mm ²	968221-1
Single wire seal JPT 1.5 mm ²	828905-1
Crimp contact JPT 1.5-2.5 mm ²	927768-3
Locking for 40 pins connector	368388-1
Locking lever for 40 pins connector (type A)	1473255-1
Housing for 40 pins connector	1473252-1

MATING CONNECTOR 81 PINS	PART NUMBER TYCO
Crimp contact MQS 0.50-0.75 mm ²	968221-1
Single wire seal JPT 1.5 mm ²	828905-1
Crimp contact JPT 1.5-2.5 mm ²	927768-3
Locking for 81 pins connector	368382-1
Locking lever for 81 pins connector (type A)	1473247-1
Housing for 81 pins connector	1473244-1

This item is a standard product, please consider the relevant datasheet notes.
The user is responsible for the product's functionality in its purposed system environment.

For more information visit us at
www.we-online.com/ics or call
+49 7940 9810-0

Würth Elektronik ICS GmbH & Co. KG Intelligent Power & Control Systems

Gewerbepark Waldzimmern
Würthstraße 1
74676 Niedernhall
Germany
Tel. +49 7940 9810-0
Fax +49 7940 9810-1099
ics@we-online.com
www.we-online.com/ics