

Product Portfolio

Portfolio Overview Capacitors

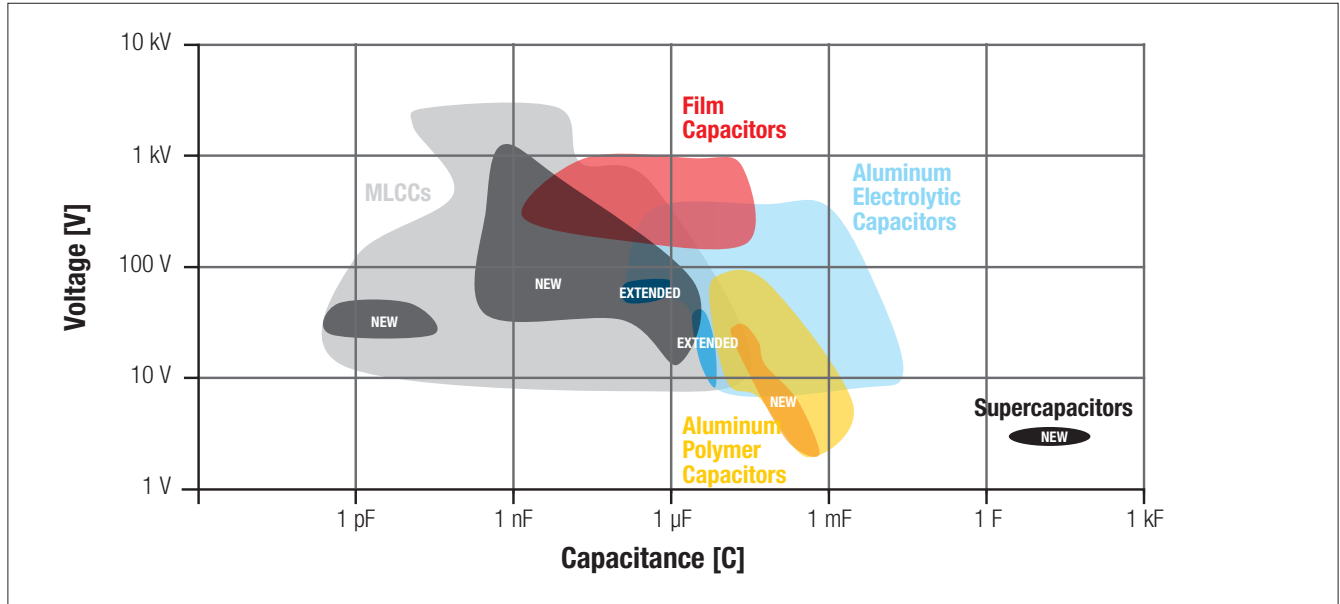

Supercapacitors (Electric Double Layer Capacitors – EDLCs)

Product series: WCAP-STSC

Supercapacitors close the gap between capacitors and batteries



Supercapacitors have:

- Higher power density than batteries
- Higher energy density than conventional capacitors

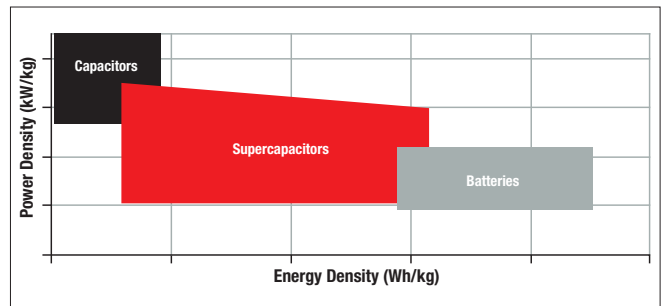

Features

- Large charge storing capacitance
- Ultra low equivalent series resistance (ESR)
- Provide a fast charging and discharging within seconds or minutes
- Cycle life is about 500 times and power output about 10 times higher compared to usual batteries
- Depending on the field of applications – possible replacement for batteries
- Easy to use: No battery charging circuit is required to prevent overcharging

Applications



Storage devices for power-offline periods



Hybrid application with battery

MLCCs – High Frequency

Product series: WCAP-CSRF

Designed for high frequency applications

- NPO ceramic for high temperature stability, low equivalent series resistance and high Q characteristics
- Inner electrode consists of an exceeding conductive material



Applications



Power amplifier



Telecommunication

MLCCs – Soft Termination

Product series: WCAP-CSST

Better absorption of mechanical stress

- Terminations with an additional conductive polymer layer
- Minimizes the risk of internal cracks
- More stable and robust performance during PCB handling as well as in the final application



Applications



Power supply



Lighting applications

Inner structure

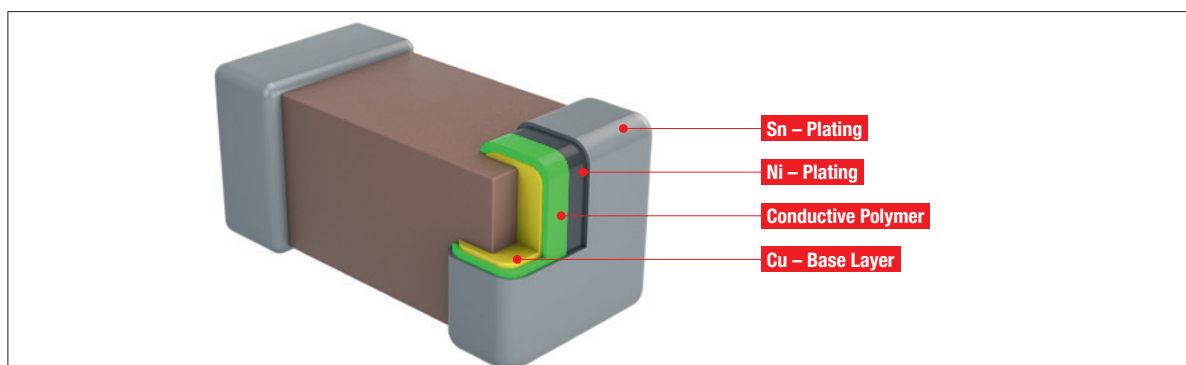

Board Flex up to 5 mm

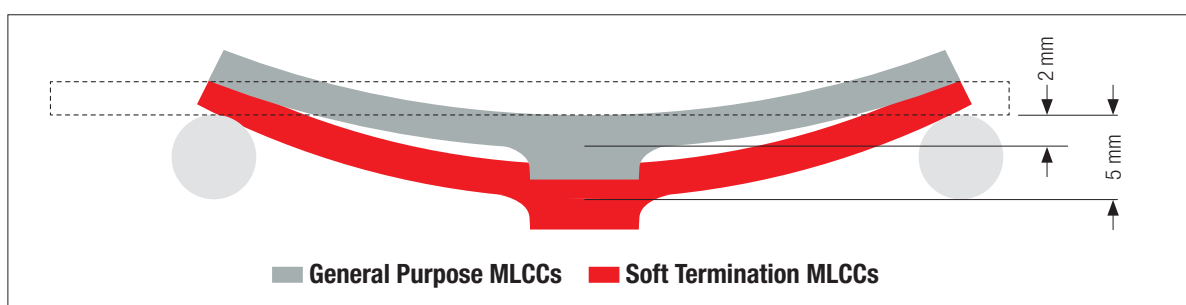

Product Portfolio

WCAP-ASLU with slim diameter of 3 mm

- Low leakage current series of V-Chip SMT Aluminum Electrolytic Capacitors
- Products with a diameter of 3 mm are now available



Applications



DC/DC converter

H-Chip Aluminum Polymer Capacitors

Product series: WCAP-PHGP, WCAP-PHSE, WCAP-PHLE

Suitable alternative for Tantalum Capacitors & MLCCs

- Aluminum Polymer technology
- Low profile surface mount (SMT) package
- Extremely low ESR and ESL
- Suitable for high ripple currents



Applications



Servers

- Input and output capacitors for SMPS
- Noise suppression
- Communication infrastructures
- Servers
- Mainboards

Inner Structure

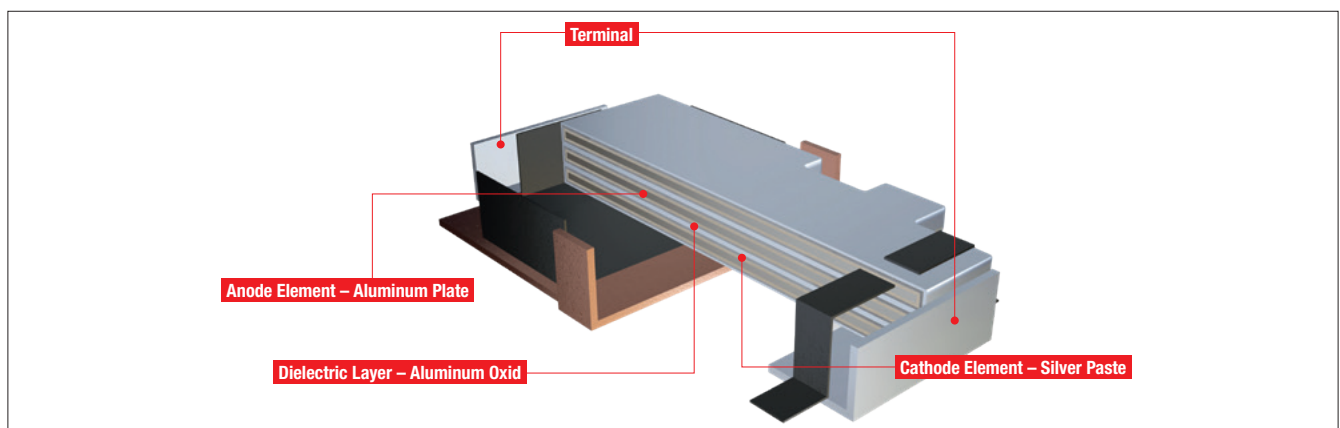

Learn more about our H-Chip Aluminum Polymer Capacitor:
https://youtu.be/Cd-Yu_UAa78



Impedance vs. Frequency

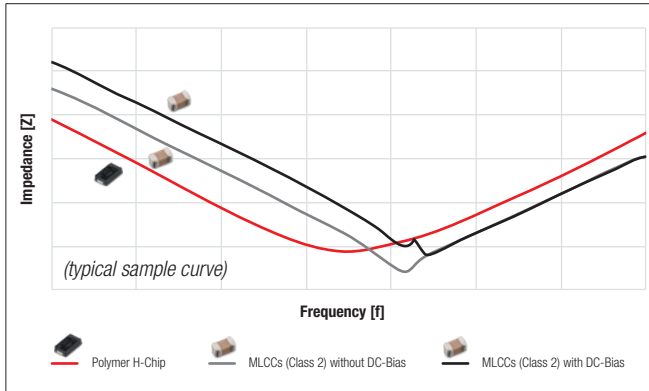

Capacitance Change vs. DC-Bias Voltage

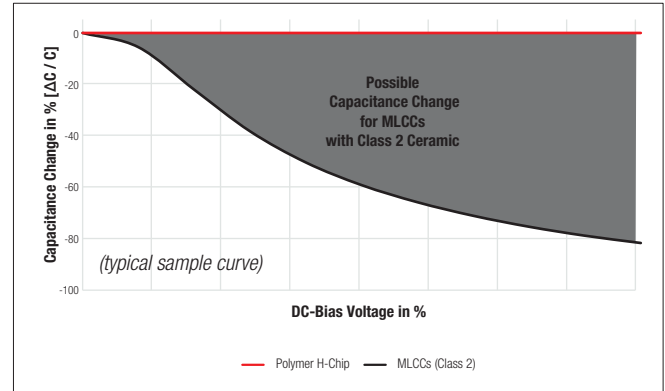

Capacitance Change vs. Temperature

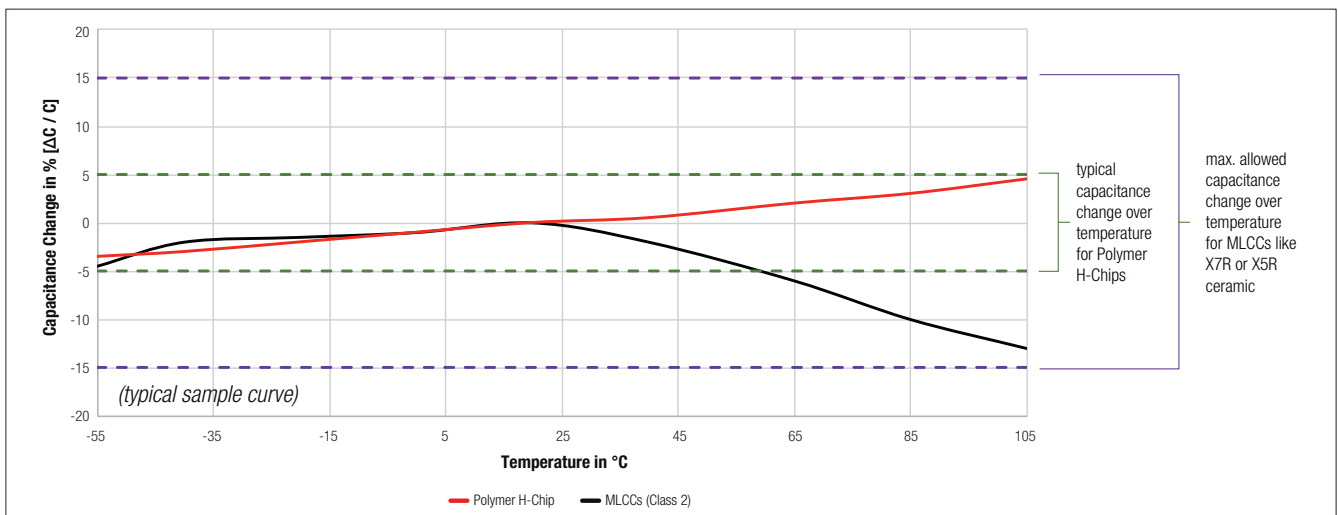

Save Space on your PCB

24 x MLCCs

- P/N: 885012107006 with 47 μF
- 24 x 47 μF = 1128 μF
- $V_R = 6.3$ V (DC)
- Size 0805 → 2 mm x 1.5 mm
- **C @ 6 V(DC) = 216 μF due to DC-Bias**
- **A = 255 mm²**

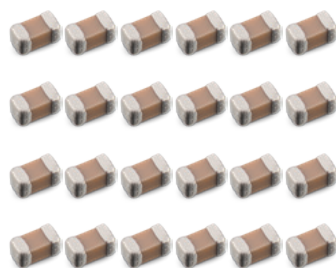

1 x H-Chip Aluminum Polymer Capacitor

- P/N: 875015119006 with 220 μF
- 1 x 220 μF = 220 μF
- $V_R = 6.3$ V (DC)
- Size 2917 → 7.3 mm x 4.3 mm
- **C @ 6 V(DC) = 220 μF**
- **A = 44 mm²**