

Description

- Standard 7.0 x 5.0mm crystal oscillator in a ceramic package with a seam sealed metal lid, hermetically sealed.
- Model **CFPS-72**
- Model Issue number **16**

Frequency Parameters

- Frequency **48.0MHz**
- Frequency Stability **±50.00ppm**
- Operating Temperature Range **0.00 to 70.00°C**
- Ageing **±5ppm per year max**

Electrical Parameters

- Supply Voltage **5.0V ±10%**
- Current Draw **35.000mA max**
- Note: parameters are referenced to 15pF load

Output Details

- Output Compatibility **CMOS**
- Drive Capability **15pF typ, 30pF max**
- Rise and Fall Time **6.0ns max**
- Duty Cycle **40/60 max**
- Start up time: 10ms max, 1.1ms typ to 90% of final amplitude (under ideal conditions @25°C).

Output Control

- Standby Operation:
Logic '1' (>70% Vs) to pad 1 enables oscillator output.
Logic '0' (<30% Vs) to pad 1 disables oscillator output; the oscillator output goes to the high impedance state.
No connection to pad 1 enables oscillator output.
Standby Current: 10µA max, 2.3µA typ @25°C.

Environmental Parameters

- Shock: Half Sine shock pulse with peak acceleration 500g; Pulse duration: 0.3ms
- Vibration: MIL-STD-202 Method 204. 5g for 20 minutes, 12 cycles in each of the 3 orientations, 10 - 2000 Hz. As per Table 11 of AEC-Q200.
- Storage Temperature Range: -55 to 125°C

Manufacturing Details

- RoHS Terminations **NiAu**
- RoHS Reflow Temp **260°C 10s max**

Compliance

- RoHS Status (2015/863/EU) **Compliant**
- REACH Status **Compliant**
- MSL Rating (JEDEC-STD-033): **Not Applicable**



Outline (mm)

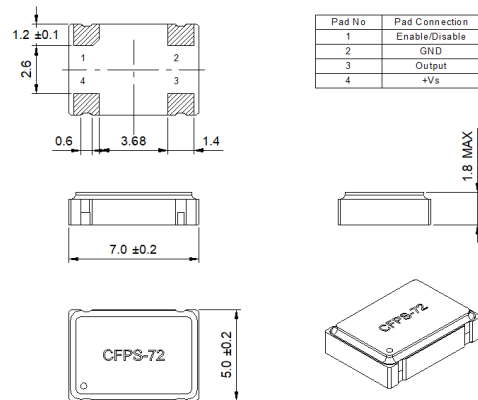

Recommended Solder Pad Layout

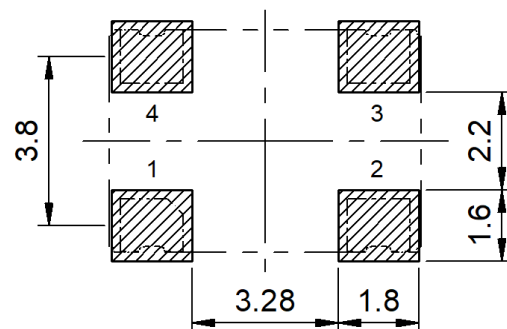

CONTACT INFORMATION:

Würth Elektronik eiSos GmbH & Co. KG
Max-Eyth-Str. 1, 74638 Waldenburg, Germany
Tel: +49(0) 7942 945-0

Email: eiSos@we-online.de
Web: www.we-online.com

Packaging Details

- Tape & reel in accordance with EIA-481
Quantities below the standard reel size to be supplied on cut tape.
Standard Quantity: 1,000 Pieces

USEFUL LINKS

Toolbox:

www.we-online.com/toolbox

Product Catalog:

www.we-online.com/products

Test Circuit

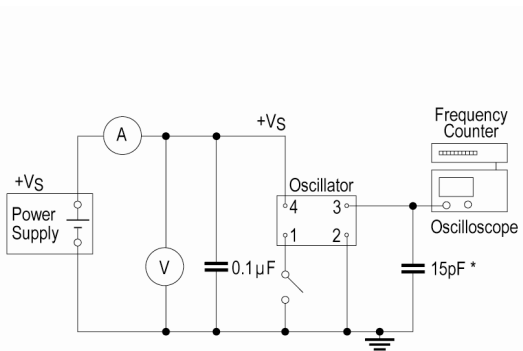

* Inclusive of jigging and equipment capacitance

Waveform

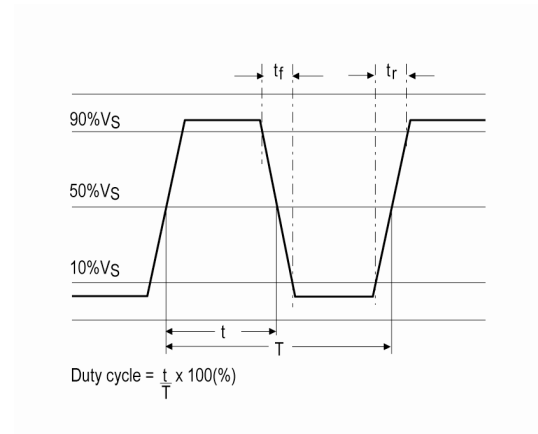

CONTACT INFORMATION:

Würth Elektronik eiSos GmbH & Co. KG
Max-Eyth-Str. 1, 74638 Waldenburg, Germany
Tel: +49(0) 7942 945-0

Email: eiSos@we-online.de
Web: www.we-online.com