

Description

- LVPECL output crystal oscillator using a high frequency fundamental crystal to give very low jitter. Hermetically sealed ceramic package with a seam sealed metal lid.
- Model IQXO-624
- Model Issue number 4
- Note: Operating temperature ranges -40 to 105°C and -40 to 125°C are intended for industrial use and not for safety critical applications such as automotive. Please contact IQD for alternative options.

Frequency Parameters

- Frequency 100.0MHz
- Frequency Stability $\pm 50.00\text{ppm}$
- Operating Temperature Range -40.00 to 105.00°C
- Ageing $\pm 3\text{ppm}$ max per year @25°C

Electrical Parameters

- Supply Voltage 3.3V $\pm 5\%$
- Current Draw 50.000mA max

Output Details

- Output Compatibility LVPECL
- Rise and Fall Time 0.5ns max
- Duty Cycle 45/55% max
- Output Voltage Levels:
Output Low (VoL): 1.680V max
Output High (VoH): 2.275V min

Output Control

- Standby Operation:
Logic '1' (70% Vs min) to pad 1 enables oscillator output.
Logic '0' (30% Vs max) to pad 1 disables oscillator output.
No connection to pad 1 enables oscillator output due to internal pull-up resistor.
- Standby Current: 10 μ A max
- Start-up Time: 10ms max

Noise Parameters

- Phase Jitter (12kHz to 20MHz): 300fs max
- Phase Jitter (12kHz to 20MHz):
@100MHz: 155fs rms typ
@125MHz: 132fs rms typ
@156.25MHz: 106fs rms typ

Environmental Parameters

- Storage Temperature Range: -55 to 125°C
- Shock: 1500g, 0.5ms, 3 times for each surface, total 18 times.
- Vibration: Frequency range: 20~2000Hz, peak to peak amplitude: 1.52mm, peak acceleration: 20g (196m/s²), 3 directions (X, Y, Z), each cycle: 20 minutes, 4 cycles for each direction.



Outline (mm)

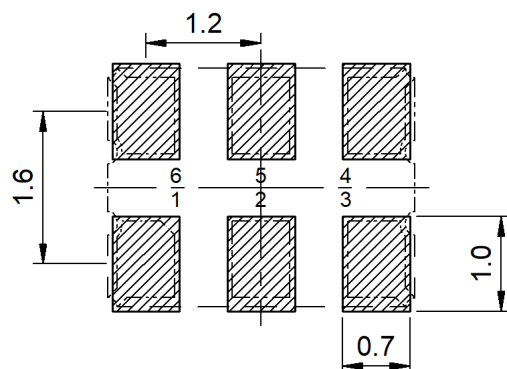
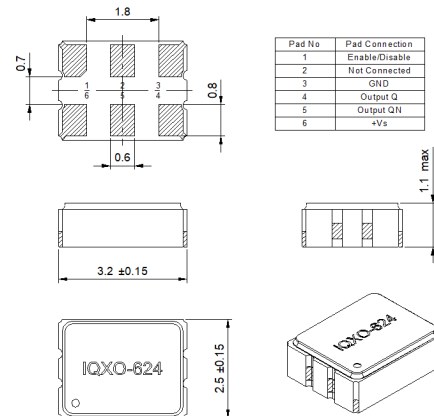

CONTACT INFORMATION:

Würth Elektronik eiSos GmbH & Co. KG
Max-Eyth-Str. 1, 74638 Waldenburg, Germany
Tel: +49(0) 7942 945-0

Email: eiSos@we-online.de
Web: www.we-online.com

Manufacturing Details

- RoHS Terminations Au over Ni
- RoHS Reflow Temp 260°C max for 10 seconds

Compliance

- RoHS Status (2015/863/EU) Compliant
- REACH Status Compliant
- MSL Rating (JDEC-STD-033): Not Applicable

Packaging Details

- Tape & reel in accordance with EIA-481
Quantities below the standard reel size to
be supplied on cut tape.
Standard Quantity: 3,000 Pieces
-

USEFUL LINKS

Toolbox:

www.we-online.com/toolbox

Product Catalog:

www.we-online.com/products

CONTACT INFORMATION:

Würth Elektronik eiSos GmbH & Co. KG
Max-Eyth-Str. 1, 74638 Waldenburg, Germany
Tel: +49(0) 7942 945-0

Email: eiSos@we-online.de
Web: www.we-online.com