

Description

- Standard 2.5 x 2.0 oscillator in a ceramic package with a hermetically sealed metal lid.
- Model IQXO-791
- Model Issue number 4

Frequency Parameters

- Frequency 50.0MHz
- Frequency Stability $\pm 25.00\text{ppm}$
- Operating Temperature Range -20.00 to 70.00°C
- Ageing $\pm 5\text{ppm max per year @ } 25^\circ\text{C}$

Electrical Parameters

- Supply Voltage $3.3\text{V} \pm 10\%$
- Current Draw 25.000mA max

Output Details

- Output Compatibility CMOS
- Drive Capability 15pF
- Rise and Fall Time 7.0ns max
- Duty Cycle $40/60\text{ max}$
- Output Voltage Levels:
Output Low (VoL): $10\%V_s\text{ max}$
Output High (VoH): $90\%V_s\text{ min}$
- Start Up Time:
 $0.7\text{ms typ to } 90\% \text{ of final amplitude (under ideal conditions @ } 25^\circ\text{C)}$
 10ms max

Output Control

- Standby Operation:
Logic '1' ($\geq 70\% V_s$) to pad 1 enables oscillator output.
Logic '0' ($\leq 30\% V_s$) to pad 1 disables oscillator output; when disabled the oscillator output goes to the high impedance state.
No connection to pad 1 enables oscillator output.
- Standby Current:
 $1.0\mu\text{A typ @ } 25^\circ\text{C}$
 $10\mu\text{A max}$

Noise Parameters

- Period Jitter (pk-pk): $\pm 80\text{ps typ}$
- Period Jitter (1σ): $\pm 10\text{ps typ}$
- RMS Phase Jitter (12kHz to 20MHz): 1ps rms max

Environmental Parameters

- Storage Temperature Range: -55 to 125°C
- Shock: Half Sine shock pulse with peak acceleration 500g ;
Pulse duration: 0.3ms
- Vibration: MIL-STD-202 Method 204. 5g for 20 minutes, 12 cycles in each of the 3 orientations, 10 - 2000 Hz. As per Table 11 of AEC-Q200.
- RoHS Terminations
- RoHS Reflow Temp $260^\circ\text{C max for } 10\text{secs max}$

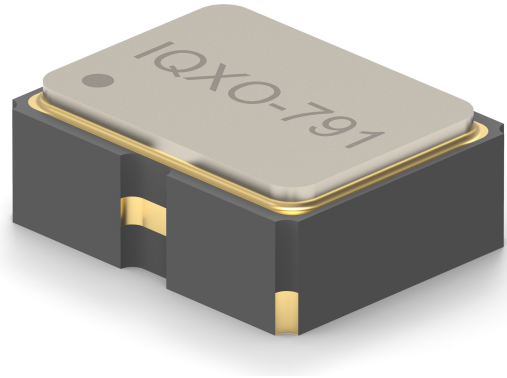

Outline (mm)

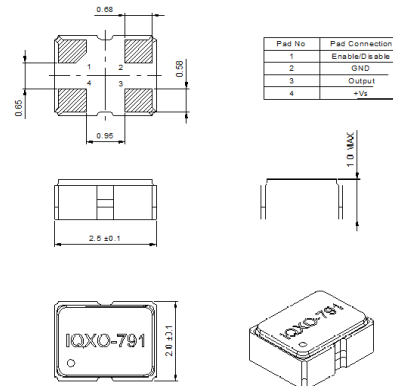

Recommended Solder Pad Layout

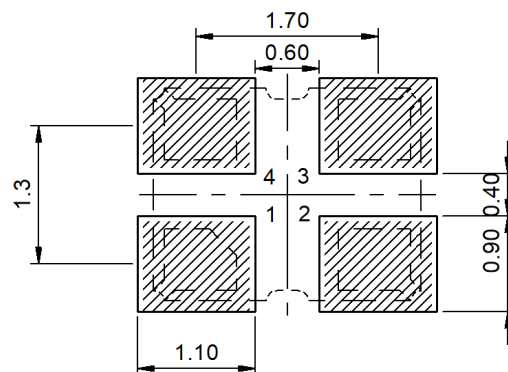

CONTACT INFORMATION:

Würth Elektronik eiSos GmbH & Co. KG
Max-Eyth-Str. 1, 74638 Waldenburg, Germany
Tel: +49(0) 7942 945-0

Email: eiSos@we-online.de
Web: www.we-online.com

Compliance

- RoHS Status (2015/863/EU) Compliant
- REACH Status Compliant
- MSL Rating (JDEC-STD-033): Not Applicable

Packaging Details

- Tape & reel in accordance with EIA-481
Quantities below the standard reel size to
be supplied on cut tape.
Standard Quantity: 3,000 Pieces

■

USEFUL LINKS

Toolbox:

www.we-online.com/toolbox

Product Catalog:

www.we-online.com/products

CONTACT INFORMATION:

Würth Elektronik eiSos GmbH & Co. KG
Max-Eyth-Str. 1, 74638 Waldenburg, Germany
Tel: +49(0) 7942 945-0

Email: eiSos@we-online.de
Web: www.we-online.com