

Description

- 1.6 x 1.0mm SMD crystal in a hermetically sealed ceramic package.
Suitable for real time clock applications.
- Model IQXC-90
- Model Issue number 2

Frequency Parameters

- Frequency 32.7680kHz
- Frequency Tolerance $\pm 20.00\text{ppm}$
- Tolerance Condition @ 25°C $\pm 5^\circ\text{C}$
- Overtone Order Fundamental
- Ageing $\pm 3\text{ppm}$ max in 1st year @ 25°C $\pm 3^\circ\text{C}$
- Frequency Stability Coefficient: $-0.036\text{ppm}/^\circ\text{C}^2 \pm 10\%$

Electrical Parameters

- Load Capacitance (CL) 4.00pF
- Shunt Capacitance (C0) 1.2pF typ
- Drive Level 500nW max
- ESR 90.00k Ω max

Environmental Parameters

- Storage Temperature Range: -55 to 125°C
- Drop: 100g dummy, 150cm drop (3 directions x 10 times) onto concrete
- Vibration: 1.5mm amplitude, 10Hz-60Hz, 15mins in 3 mutually perpendicular planes, duration 2hrs each plane

Compliance

- RoHS Status (2015/863/EU) Compliant
- REACH Status Compliant
- MSL Rating (JDEC-STD-033): Not Applicable

Packaging Details

- Tape & reel in accordance with EIA-481
Quantities below the standard reel size to be supplied on cut tape.
Standard Quantity: 5,000 Pieces

USEFUL LINKS

Toolbox:

www.we-online.com/toolbox

Product Catalog:

www.we-online.com/products

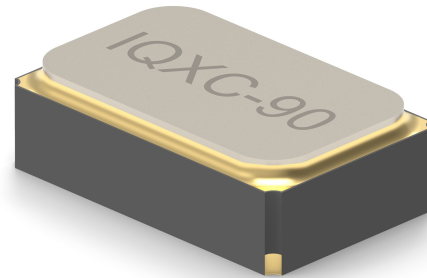

Outline (mm)

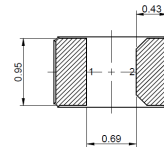

Pad Connections
1. Crystal
2. Crystal

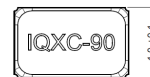
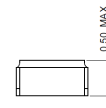
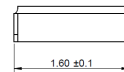

Recommended Solder Pad Layout

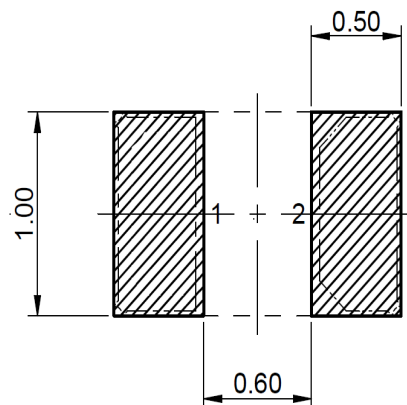

CONTACT INFORMATION:

Würth Elektronik eiSos GmbH & Co. KG
Max-Eyth-Str. 1, 74638 Waldenburg, Germany
Tel: +49(0) 7942 945-0

Email: eiSos@we-online.de
Web: www.we-online.com

Typical Frequency Stability Characteristics

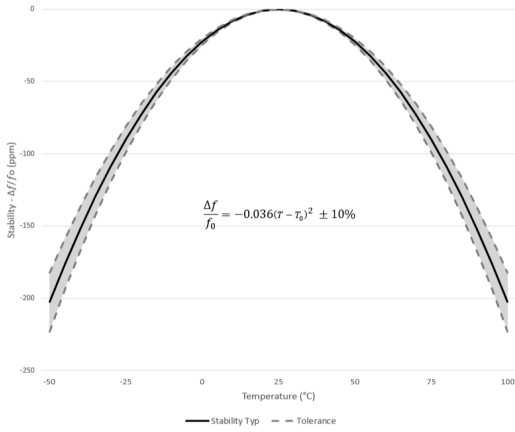

Reflow Profile

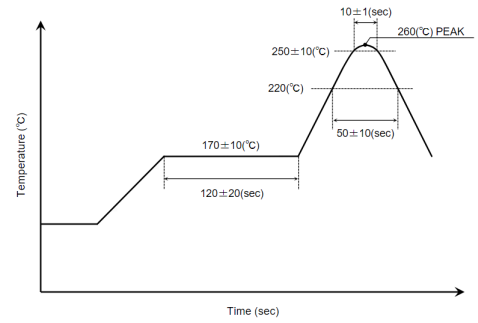

Note:

- (1) The temperature used herein means the temperature on the circuit board.
- (2) Reflow is permitted 2 times.

CONTACT INFORMATION:

Würth Elektronik eiSos GmbH & Co. KG
 Max-Eyth-Str. 1, 74638 Waldenburg, Germany
 Tel: +49(0) 7942 945-0

Email: eiSos@we-online.de
 Web: www.we-online.com