

Description

- Standard 5x3.2mm SMD crystal with four pads.
Ceramic package with a seam sealed metal lid, hermetically sealed.
- Model CFPX-104
- Model Issue number 11

Frequency Parameters

- Frequency 20.0MHz
- Frequency Tolerance ± 20.00 ppm
- Tolerance Condition @25°C
- Frequency Stability ± 30.00 ppm
- Operating Temperature Range -40.00 to 85.00°C
- Overtone Order Fundamental
- Ageing ± 3 ppm max per year @25°C

Electrical Parameters

- Load Capacitance (CL) 18.00pF
- Shunt Capacitance (C0) 7pF max
- Drive Level 100µW max
- ESR 50.00Ω max

Environmental Parameters

- Shock: 1500g, 0.5ms, 3 times in each of 3 mutually perpendicular planes.
- Vibration: MIL-STD-883F, 20g (20Hz~2000Hz), 1.52mm amplitude, 20 minutes in 3 mutually perpendicular planes, 4 cycles.
- Storage Temperature Range: -55 to 125°C

Manufacturing Details

- RoHS Terminations Au 0.3µm~1.0µm
- RoHS Reflow Temp 260°C max for 30 seconds

Compliance

- RoHS Status (2015/863/EU) Compliant
- REACH Status Compliant
- MSL Rating (JDEC-STD-033): Not Applicable

Packaging Details

- Tape & reel in accordance with EIA-481
Quantities below the standard reel size to be supplied on cut tape.
Standard Quantity: 1,000 Pieces

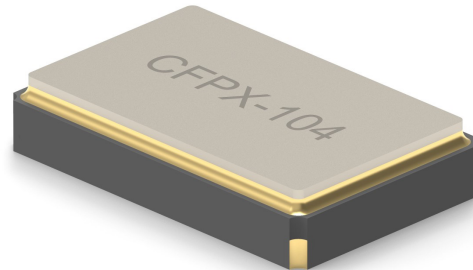

Outline (mm)

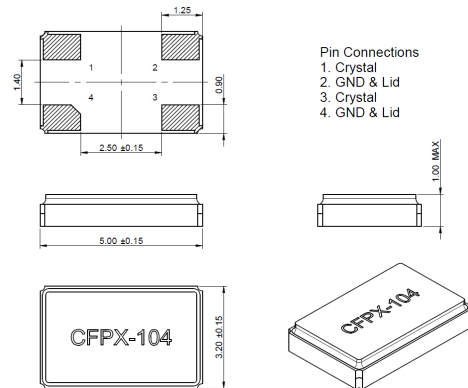

- Pin Connections
- Crystal
 - GND & Lid
 - Crystal
 - GND & Lid

NOTE: The chamfer may appear on pad 1 or 4.
This causes no change to the electrical performance of the device.

Recommended Solder Pad Layout

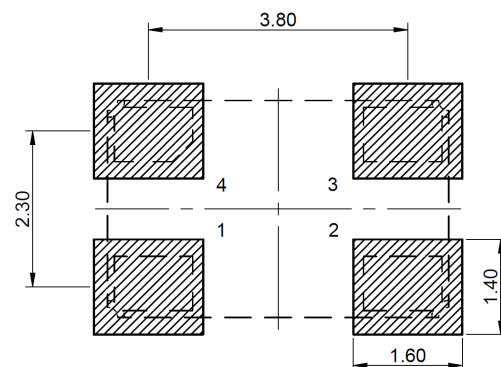

CONTACT INFORMATION:

Würth Elektronik eiSos GmbH & Co. KG
Max-Eyth-Str. 1, 74638 Waldenburg, Germany
Tel: +49(0) 7942 945-0

Email: eiSos@we-online.de
Web: www.we-online.com



Quartz Crystal Specification

IQD Part No.: LFX TAL056808

Würth Part No. 830056808



**WÜRTH
ELEKTRONIK**
MORE THAN
YOU EXPECT

USEFUL LINKS

Toolbox:

www.we-online.com/toolbox

Product Catalog:

www.we-online.com/products

CONTACT INFORMATION:

Würth Elektronik eiSos GmbH & Co. KG
Max-Eyth-Str. 1, 74638 Waldenburg, Germany
Tel: +49(0) 7942 945-0

Email: eiSos@we-online.de
Web: www.we-online.com