

### Description

- Standard 5x3.2mm SMD crystal with four pads.  
Ceramic package with a seam sealed metal lid, hermetically sealed.
- Model CFPX-104
- Model Issue number 11

### Frequency Parameters

- Frequency 24.0MHz
- Frequency Tolerance  $\pm 10.00\text{ppm}$
- Tolerance Condition @25°C
- Frequency Stability  $\pm 25.00\text{ppm}$
- Operating Temperature Range -40.00 to 85.00°C
- Overtone Order Fundamental
- Ageing  $\pm 3\text{ppm}$  max per year @25°C

### Electrical Parameters

- Load Capacitance (CL) 18.00pF
- Shunt Capacitance (C0) 7pF max
- Drive Level 100µW max
- ESR 40.00Ω max

### Environmental Parameters

- Shock: 1500g, 0.5ms, 3 times in each of 3 mutually perpendicular planes.
- Vibration: MIL-STD-883F, 20g (20Hz~2000Hz), 1.52mm amplitude, 20 minutes in 3 mutually perpendicular planes, 4 cycles.
- Storage Temperature Range: -55 to 125°C

### Manufacturing Details

- RoHS Terminations Au 0.3µm~1.0µm
- RoHS Reflow Temp 260°C max for 30 seconds

### Compliance

- RoHS Status (2015/863/EU) Compliant
- REACH Status Compliant
- MSL Rating (JDEC-STD-033): Not Applicable

### Packaging Details

- Tape & reel in accordance with EIA-481  
Quantities below the standard reel size to be supplied on cut tape.  
Standard Quantity: 1,000 Pieces

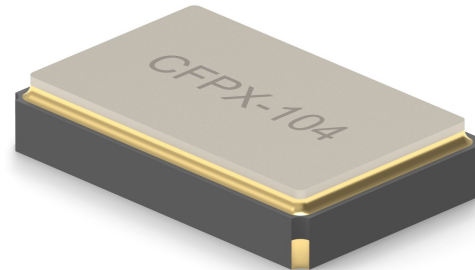

### Outline (mm)

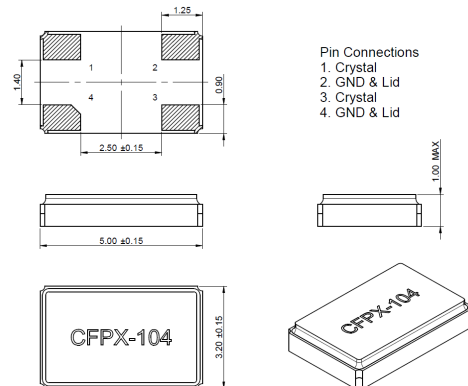

NOTE: The chamfer may appear on pad 1 or 4.  
This causes no change to the electrical performance of the device.

### Recommended Solder Pad Layout

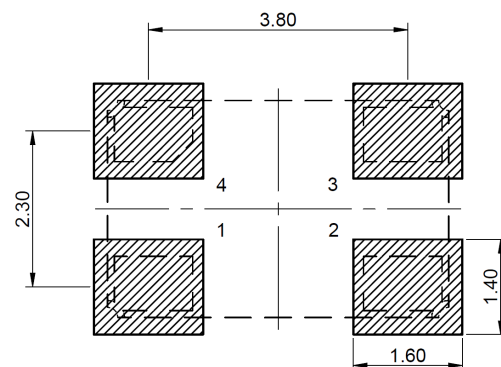

### CONTACT INFORMATION:

Würth Elektronik eiSos GmbH & Co. KG  
 Max-Eyth-Str. 1, 74638 Waldenburg, Germany  
 Tel: +49(0) 7942 945-0

Email: eiSos@we-online.de  
 Web: www.we-online.com



## Quartz Crystal Specification

*IQD Part No.: LFX TAL053798*

*Würth Part No. 830053798*



**WÜRTH  
ELEKTRONIK**  
MORE THAN  
YOU EXPECT

---

### USEFUL LINKS

Toolbox:

[www.we-online.com/toolbox](http://www.we-online.com/toolbox)

Product Catalog:

[www.we-online.com/products](http://www.we-online.com/products)

---

### CONTACT INFORMATION:

Würth Elektronik eiSos GmbH & Co. KG  
Max-Eyth-Str. 1, 74638 Waldenburg, Germany  
Tel: +49(0) 7942 945-0

Email: [eiSos@we-online.de](mailto:eiSos@we-online.de)  
Web: [www.we-online.com](http://www.we-online.com)