

Description

- Industry standard SMD crystal.
Resistance welded, hermetically sealed in an inert atmosphere, glass to metal seals on leads.
Lead wires are mounted onto a plastic former to create a gull wing mount.
- Model HC49/4HSMX
- Model Issue number 19

Frequency Parameters

- Frequency 11.05920MHz
- Frequency Tolerance $\pm 30.00\text{ppm}$
- Tolerance Condition @25°C
- Frequency Stability $\pm 50.00\text{ppm}$
- Operating Temperature Range -20.00 to 70.00°C
- Overtone Order Fundamental
- Ageing $\pm 5\text{ppm typ per year @25°C}$

Electrical Parameters

- Load Capacitance (CL) 20.00pF
- Shunt Capacitance (C0) 7pF max
- Drive Level 500µW max
- ESR 40.00Ω max

Environmental Parameters

- Shock: MIL-STD-202 Method 213, Condition C, Half sine shock pulse peak acceleration of 100g, pulse duration 6ms.
- Vibration: MIL-STD-202 Method 204, 5g for 20 minutes, 12 cycles in each of the 3 orientations, 10~2000Hz.
- Storage Temperature Range: -55 to 125°C

Manufacturing Details

- RoHS Terminations Sn, Ag & Cu
- RoHS Reflow Temp 260°C max for 10 seconds

Compliance

- RoHS Status (2015/863/EU) Compliant
- REACH Status Compliant
- MSL Rating (JEDEC-STD-033): Not Applicable

Packaging Details

- Tape & reel in accordance with EIA-481
Quantities below the standard reel size to be supplied on cut tape.
Standard Quantity: 1,000 Pieces



Outline (mm)

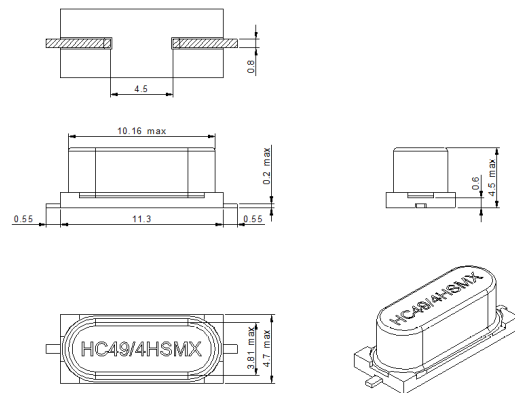

Recommended Solder Pad Layout

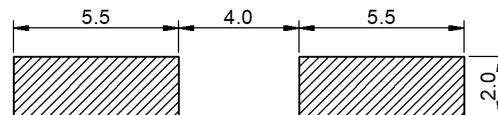

CONTACT INFORMATION:

Würth Elektronik eiSos GmbH & Co. KG
Max-Eyth-Str. 1, 74638 Waldenburg, Germany
Tel: +49(0) 7942 945-0

Email: eiSos@we-online.de
Web: www.we-online.com



Quartz Crystal Specification

IQD Part No.: LFX TAL028928

Würth Part No. 830028928



**WÜRTH
ELEKTRONIK**
MORE THAN
YOU EXPECT

USEFUL LINKS

Toolbox:

www.we-online.com/toolbox

Product Catalog:

www.we-online.com/products

CONTACT INFORMATION:

Würth Elektronik eiSos GmbH & Co. KG
Max-Eyth-Str. 1, 74638 Waldenburg, Germany
Tel: +49(0) 7942 945-0

Email: eiSos@we-online.de
Web: www.we-online.com