

### Description

- Industry standard SMD crystal.  
Resistance welded, hermetically sealed in an inert atmosphere, glass to metal seals on leads.  
Lead wires are mounted onto a plastic former to create a gull wing mount.
- Model HC49/4HSMX
- Model Issue number 19

### Frequency Parameters

- Frequency 4.0MHz
- Frequency Tolerance  $\pm 30.00\text{ppm}$
- Tolerance Condition @25°C
- Frequency Stability  $\pm 50.00\text{ppm}$
- Operating Temperature Range -10.00 to 60.00°C
- Overtone Order Fundamental
- Ageing  $\pm 5\text{ppm typ per year @25°C}$

### Electrical Parameters

- Load Capacitance (CL) 30.00pF
- Shunt Capacitance (C0) 7pF max
- Drive Level 500µW max
- ESR 130.00Ω max

### Environmental Parameters

- Shock: MIL-STD-202 Method 213, Condition C, Half sine shock pulse peak acceleration of 100g, pulse duration 6ms.
- Vibration: MIL-STD-202 Method 204, 5g for 20 minutes, 12 cycles in each of the 3 orientations, 10~2000Hz.
- Storage Temperature Range: -55 to 125°C

### Manufacturing Details

- RoHS Terminations Sn, Ag & Cu
- RoHS Reflow Temp 260°C max for 10 seconds

### Compliance

- RoHS Status (2015/863/EU) Compliant
- REACH Status Compliant
- MSL Rating (JEDEC-STD-033): Not Applicable

### Packaging Details

- Tape & reel in accordance with EIA-481  
Quantities below the standard reel size to be supplied on cut tape.  
Standard Quantity: 1,000 Pieces



### Outline (mm)

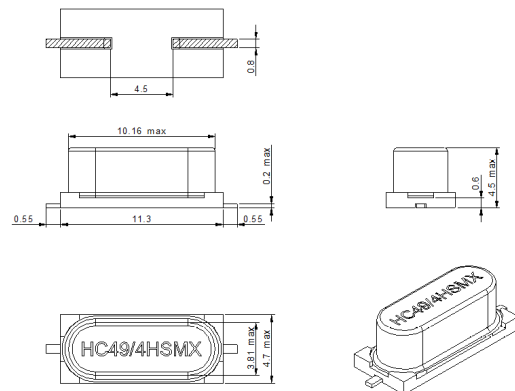

### Recommended Solder Pad Layout



### CONTACT INFORMATION:

Würth Elektronik eiSos GmbH & Co. KG  
Max-Eyth-Str. 1, 74638 Waldenburg, Germany  
Tel: +49(0) 7942 945-0

Email: [eiSos@we-online.de](mailto:eiSos@we-online.de)  
Web: [www.we-online.com](http://www.we-online.com)



## Quartz Crystal Specification

*IQD Part No.: LFX TAL011300*

*Würth Part No. 830011300*



**WÜRTH  
ELEKTRONIK**  
MORE THAN  
YOU EXPECT

---

### USEFUL LINKS

Toolbox:

[www.we-online.com/toolbox](http://www.we-online.com/toolbox)

Product Catalog:

[www.we-online.com/products](http://www.we-online.com/products)

---

### CONTACT INFORMATION:

Würth Elektronik eiSos GmbH & Co. KG  
Max-Eyth-Str. 1, 74638 Waldenburg, Germany  
Tel: +49(0) 7942 945-0

Email: [eiSos@we-online.de](mailto:eiSos@we-online.de)  
Web: [www.we-online.com](http://www.we-online.com)