

Description

- Industry standard leaded package
Resistance welded, hermetically sealed in an inert atmosphere, glass to metal seals on leads
- Standard 2 leg HC49 package
- Model HC49
- Model Issue number 16

Frequency Parameters

- Frequency 10.0MHz
- Frequency Tolerance ± 20.00 ppm
- Frequency Stability ± 50.00 ppm
- Operating Temperature Range -10.00 to 60.00°C
- Overtone Order Fundamental
- Ageing ± 5 ppm max per year

Electrical Parameters

- Load Capacitance 30.00pF
- Shunt Capacitance 7pF max
- Drive Level 1mW max
- ESR 35.00Ω max

Environmental Parameters

- Shock: MIL-STD-202 Method 213, Condition C, Half sine shock pulse peak acceleration of 100g, pulse duration 6ms.
- Vibration: MIL-STD-202 Method 204, 5g for 20 minutes, 12 cycles in each of the 3 orientations, 10~2000Hz.
- Storage Temperature Range: -55 to 125°C

Manufacturing Details

- RoHS Terminations Sn, Ag & Cu
- RoHS Reflow Temp 260°C max over 10 seconds

Compliance

- RoHS Status (2015/863/EU) Compliant
- REACH Status Compliant
- MSL Rating (JDEC-STD-033): Not Applicable

Packaging Details

- Bulk pack
Standard Quantity: 100 Pieces

USEFUL LINKS

Toolbox:

www.we-online.com/toolbox

Product Catalog:

www.we-online.com/products



Outline (mm)

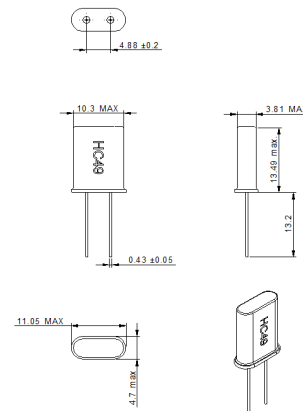

CONTACT INFORMATION:

Würth Elektronik eiSos GmbH & Co. KG
Max-Eyth-Str. 1, 74638 Waldenburg, Germany
Tel: +49(0) 7942 945-0

Email: eiSos@we-online.de
Web: www.we-online.com