

### Description

- Industry standard leaded package  
Resistance welded, hermetically sealed in an inert atmosphere, glass to metal seals on leads
- Standard 2 leg HC49 package
- Model HC49
- Model Issue number 16

### Frequency Parameters

- Frequency 4.91520MHz
- Frequency Tolerance  $\pm 20.00$ ppm
- Frequency Stability  $\pm 50.00$ ppm
- Operating Temperature Range  $-10.00$  to  $60.00^{\circ}\text{C}$
- Overtone Order Fundamental
- Ageing  $\pm 5$ ppm max per year

### Electrical Parameters

- Load Capacitance 30.00pF
- Shunt Capacitance 7pF max
- Drive Level 1mW max
- ESR 100.00 $\Omega$  max

### Environmental Parameters

- Shock: MIL-STD-202 Method 213, Condition C, Half sine shock pulse peak acceleration of 100g, pulse duration 6ms.
- Vibration: MIL-STD-202 Method 204, 5g for 20 minutes, 12 cycles in each of the 3 orientations, 10~2000Hz.
- Storage Temperature Range:  $-55$  to  $125^{\circ}\text{C}$

### Manufacturing Details

- RoHS Terminations Sn, Ag & Cu
- RoHS Reflow Temp  $260^{\circ}\text{C}$  max over 10 seconds

### Compliance

- RoHS Status (2015/863/EU) Compliant
- REACH Status Compliant
- MSL Rating (JEDEC-STD-033): Not Applicable

### Packaging Details

- Bulk pack  
Standard Quantity: 100 Pieces

## USEFUL LINKS

#### Toolbox:

[www.we-online.com/toolbox](http://www.we-online.com/toolbox)

#### Product Catalog:

[www.we-online.com/products](http://www.we-online.com/products)



### Outline (mm)

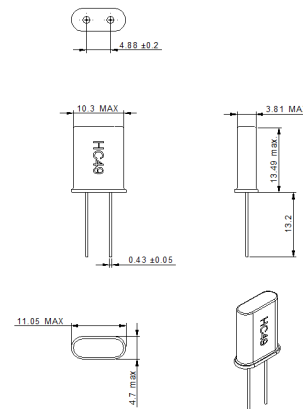

### CONTACT INFORMATION:

Würth Elektronik eiSos GmbH & Co. KG  
Max-Eyth-Str. 1, 74638 Waldenburg, Germany  
Tel: +49(0) 7942 945-0

Email: [eiSos@we-online.de](mailto:eiSos@we-online.de)  
Web: [www.we-online.com](http://www.we-online.com)