

REDLINE POWER BOX M PLUS

Standard version

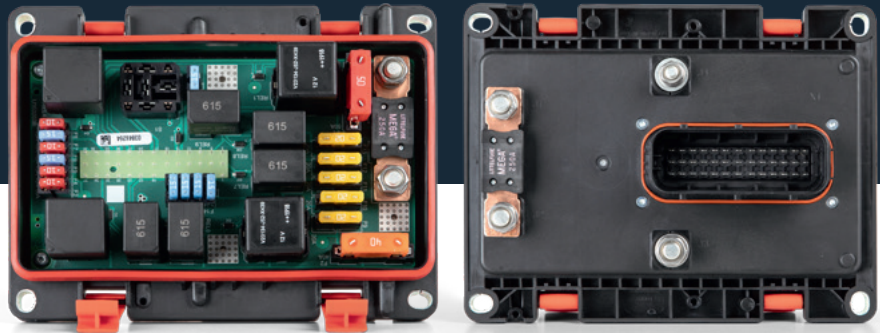

The **REDline Power Box M Plus** is the ideal solution for decentralised power distribution modules that have to be located in the motor area or on the chassis. It provides up to four high power inputs (up to 200 A) and a large PCB surface that can be customised to your needs.

It is equipped with:

- A 174 x 100 mm PCB area
- Up to four power inputs
- A 31 / 39-pin or 62-pin LeavySeal connector

Standard version of the product is presented on the first three pages of this document. Customisation of the box content can be realised according to your requirements. Refer to page 4 and contact us for more information.

The advantages of our REDline Power Boxes summarised:

- **Robust & durable:** Thanks to high IP levels and cable harness reduction
- **Fast project processing:** Due to a broad range of standardised housings and a structured and established product development process
- **High economic efficiency:** Resulting from simplified installation and maintenance as well as low tooling and engineering costs
- **Convincing service concept:** We support you from the first idea up to serial production of your tailor-made solution and beyond
- **Compact & modular architecture:** Thanks to the modular building block system, the customer-specific configurable PCB and the efficient use of space

Mechanical data	
Box dimensions	193 x 148.8 x 97.3 mm
PCB dimensions	174 x 100 mm
Operating temperature	-40 °C up to +85 °C
IP protection class	IP66 / IP69K (dust proof / protected against powerful water jets under pressure)
Specifics	Integrated compression limiter MEGA fuse on the outside of the box Possible MEGA fuse integration on the outside of the box

Electrical data	
Power inputs	1 x M6 Powerelement 3 x M8 Powerelements
Connector	1 x LeavySeal 39-pin
Components	11 x MINI fuses 5 x ATO fuses 2 x MAXI fuses 1 x MEGA fuse 5 x Micro relays 2 x Mini relays 2 x Power relays 1 x Micro ICCS relay

Mating connectors			
Pins	Coding	Standard	V0 Material
39	E	5-1718321-3	5-2208684-3

This item is a standard product, please consider the relevant datasheet notes. The user is responsible for the product's functionality in its purposed system environment. Technical content may be modified and changed by Würth Elektronik ICS GmbH & Co. KG without any notice.

REDLINE POWER BOX M PLUS

Standard version

Qualification		
Test methods	Qualification norm	Descriptions
IP protection class	ISO 20653: 2013-02	IP66 / IP69K
Low & high temperature	ISO 16750-4: 2010-04	Temperature: -40 °C / +85 °C
Low temperature operation	ISO 16750-4	Duration: 24 h Temperature: -30 °C
High temperature operation	ISO 16750-4	Duration: 48 h / 96 h Temperature: +85 °C
Temperature cycling with specified change rate	ISO 16750-4	Number of cycles: 30 Cycle duration: 240 h Temperature: -40 °C / +85 °C
Damp heat cyclic	ISO 16750-4 IEC 60068-2-30	Number of cycles: 6 Cycle duration: 144 h Temperature: +55 °C
Rapid change of temperature with specified transition duration	ISO 16750-4 IEC 60068-2-14	Number of cycles: 100 Cycle duration: 100 h Temperature: -40 °C / +85 °C
Dewing test	ISO 16750-4	Number of cycles: 5 Cycle duration: 25 h Temperature: +80 °C
Mechanical shock	ISO 16750-3	Pulse shape: half-sinusoidal Acceleration: 500 m/s ² Duration: 6 mn Number of shocks: 10 per direction
Vibration test	ISO 16750-3	RMS: 57.9 m/s ² Duration: 32 h per axis Temperature: -40 °C / +85 °C
Free fall	ISO 16750-3	Number of DUT: 3 Falls per DUT: 2 Drop height: 1 m

Torque fixing point	
Compatibility	Up to ISO class 8.8 screws

Torque electric connection	
M6	3.9 Nm (1 x on M Plus)
M8	9.0 Nm (3 x on M Plus)

Order Information	
REDline Power Box M Plus Standard	
Unequipped (without fuses and relays)	ICS-103263
Equipped with 12 V fuses and relays	ICS-103263-12V
Equipped with 24 V fuses and relays	ICS-103263-24V

Box dimensions

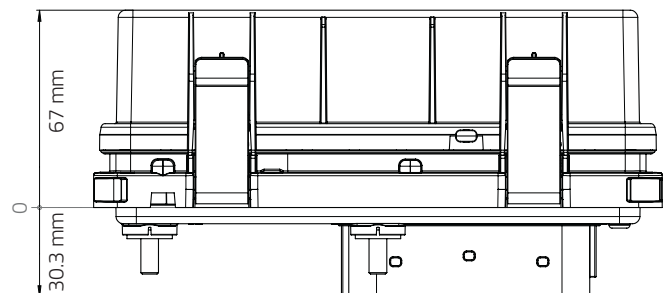
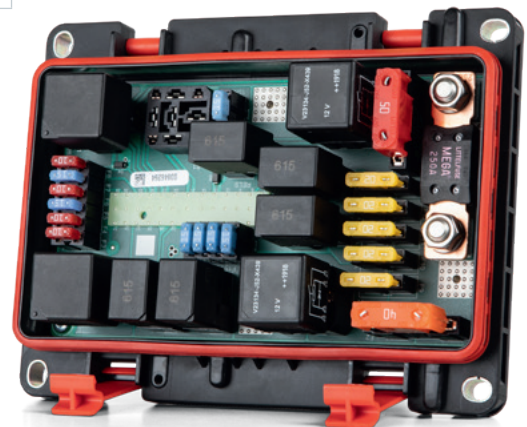
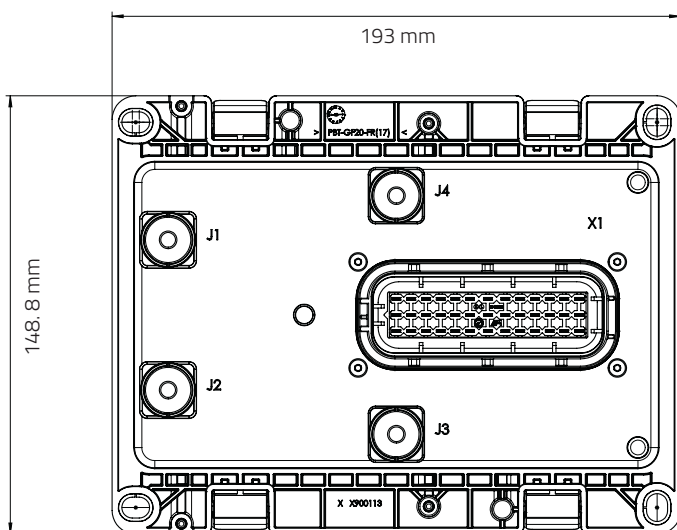

REDLINE POWER BOX M PLUS

Standard version

PCB silkscreen

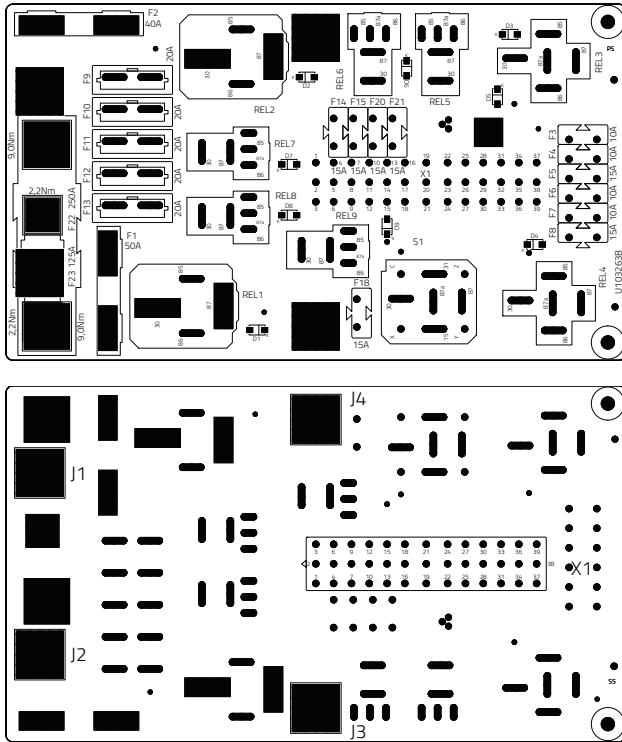

Pin assignment

X1 connector	
Pin	Description
1	20A/REL7.87a
2	20A/REL7.87
3	20A/REL8.87
4	15A/F14
5	2A/REL7.86
6	20A/REL8.87a
7	15A/F15
8	2A/REL8.86
9	20A/REL9.87
10	15A/F20.1
11	3A/REL2.86
12	20A/REL9.87a
13	15A/F21.1
14	2A/REL9.86
15	10A/GND
16	15A/F20.2
17	5A/Status
18	15A/S1.87a
19	15A/F21.2
20	2A/REL5.86
21	1A/S1.Z
22	2A/REL6.86
23	5A/S1.15

X1 connector	
Pin	Description
24	15A/S1.87
25	20A/REL6.87
26	3A/REL1.86
27	1A/S1.Y
28	20A/REL6.87a
29	3A/REL3.86
30	1A/S1.X
31	20A/REL5.87
32	3A/REL4.86
33	15A/F8
34	20A/REL5.87a
35	10A/F4
36	10A/F7
37	10A/F3
38	15A/F5
39	10A/F6

J connector	
Pin	Description
J1.1	250A/J1
J2.1	250A/KL30
J3.1	40A/REL2
J4.1	50A/REL1

Electrical schematic

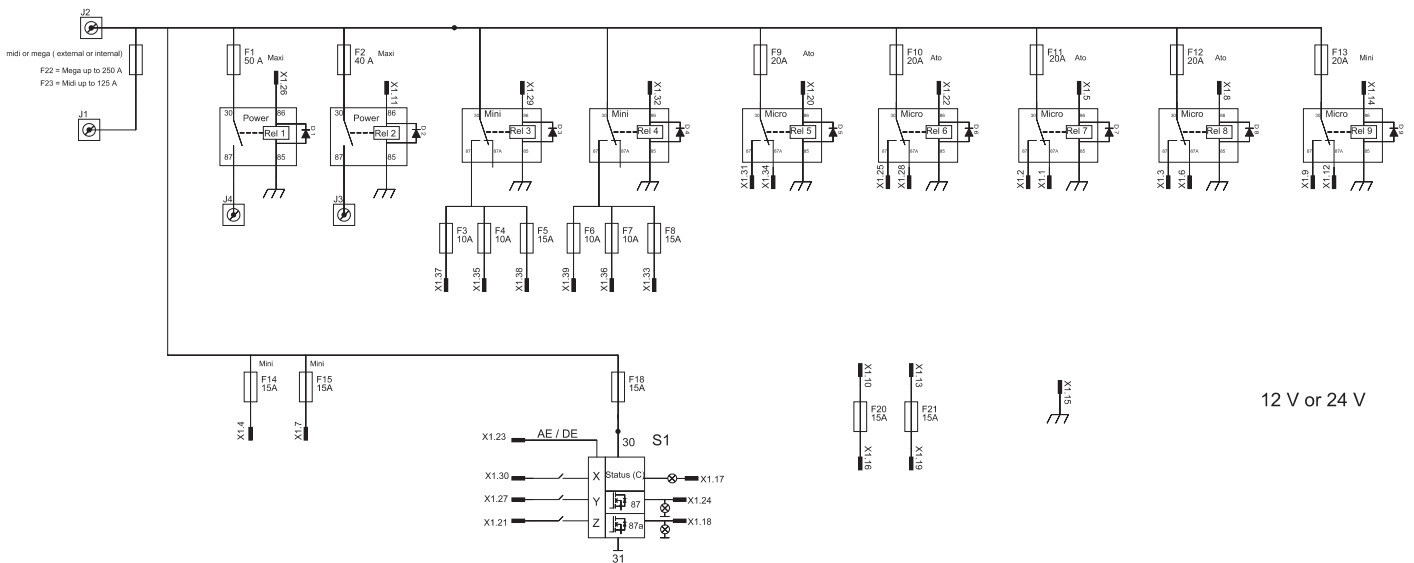

REDLINE POWER BOX M PLUS

Customisation possibilities

Do you want to customise the REDline Power Box M Plus content according to your needs? With the following three steps, we help you to get your tailor-made solution.

1

Choose desired inputs and outputs according to your electrical schematic

2

Select the components to be integrated and get the PCB designed according to your electrical schematic

3

Choose your additional component options

Inputs / Outputs

Threaded: M5, M6 or M8
 Radlok™: 3.6, 5.7 or 8
 SurLok Plus™: 3.6, 5.7 or 8
 LED indicator
 Closed input

Compatible connectors

Pins	Coding	Standard	VO Material
31	E	1-1564297-6	1-2208685-6
39	E	5-1718321-3	5-2208684-3
39	F	6-1718321-3	6-2208684-3
62	A	1-1418883-1	1-1823498-1
62	B	2-1418883-1	2-1823498-1

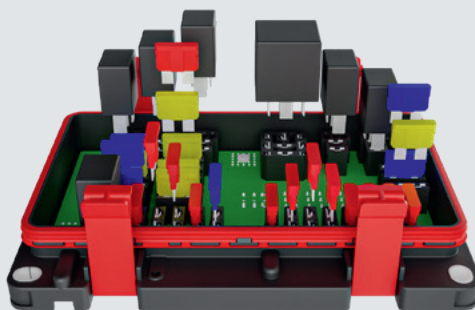

Component options

Cover leash
 Fuse tester
 Fuse puller
 Customer logo on lid
 Components sticker
 Optional pass-through seal for installation
 Optional pass-through seal for firewall installation

Profit from different standard box variants and component options for advanced functions and requirements.

Box variants	Part number WE ICS		
	Unequipped (without fuses and relays)	Equipped with 12 V fuses and relays	Equipped with 24 V fuses and relays
REDline Twin Standard	ICS-103040	ICS-103040-12V	ICS-103040-24V
REDline Hybrid Standard	ICS-103037	ICS-103037-12V	ICS-103037-24V
REDline M Plus Standard	ICS-103263	ICS-103263-12V	ICS-103263-24V
REDline Medium Standard	ICS-103038	ICS-103038-12V	ICS-103038-24V
REDline Mini Standard	ICS-103039	ICS-103039-12V	ICS-103039-24V
REDline 6F Standard	ICS-104012	ICS-104010	ICS-104011

Are you looking for a box with special requirements?

No problem, just contact us! We develop your customer-specific product according to the motto: more than you expect. From the idea through to the start of serial production.



Twin



Hybrid



M Plus



Medium



Mini



6F

For more information write us an e-mail ics@we-online.com, call +49 7940 9810-0 or visit us at www.we-online.com/ics

Würth Elektronik ICS GmbH & Co. KG
 Intelligent Power & Control Systems
 Gewerbepark Waldzimmern · Würthstraße 1
 74676 Niedernhall · Germany
 Tel.: +49 7940 9810-0 · Fax +49 7940 9810-1099
ics@we-online.com · www.we-online.com/ics