



α Rack & Ω Rack

The flexible rack system for smart prototyping

Module options
Product overview
User manual





αRack

ΩRack



Table of Contents

	Page
Why use the αRack & ΩRack?	6
αRack	8 – 61
Ordering	14 – 15
Modules	16 – 45
Box assortment	47
Expandability	48
Tower 1–3	49–51
Pedestal set	52
Dimensions of α Rack Tower	53
Wall bracket & assembly instruction	54–55
Assembly instruction	56–61
ΩRack	62 – 75
Ordering	68–69
Details on stocking Module 1	70–71
Ω Rack dimensions	71
Combinations	72
Ω Rack parts overview	73
Variations options	74
Assembly instruction	75

all in

twΩ

α Rack & Ω Rack

The flexible rack system for smart prototyping

- Ideal for organizing existing and upcoming Würth Elektronik Design Kits
- Smart storage boxes in design and function
- Combinable to suit your needs and your space concept
- Two versions: α -Rack and Ω -Rack
- Free refill of Design Kits and storage boxes
- Important technical data at a glance (directly on the box)
- Fast access to online datasheet via QR code
- Support from our technical field sales



α&Ω



α

αRack

αRack variants



αRacks can be set up
on a rotating tower base,
in a cabinet,
next to each other,
on top of each other,
it can be attached
to a wall bracket ...



αRack benefits

Compact, versatile and innovative

- Organizational system for components, design kits and documents
- Fast & easy access to components
- All technical information at a glance
- Free-standing option *(table, cabinet etc.)*
- Stockable
- Dustproof through closed design
- Modular expandable
- Wall bracket and mobile rotating tower *(optional)*

























































Let's order, but how ...?



STEP 1

Select modules *Page 16–45*

STEP 2

Select options

Module	Order Code			
Module 01	742 707 001			
Module 02	742 707 002			
Module 03	742 707 003			
Module 04	742 707 004			
Module 05	742 707 005			
Module 06	742 707 006			
Module 07	742 707 007			
Module 08	742 707 008			
Module 09	742 707 009			
Module 10	742 707 010			
Module 11	742 707 011			
Module 12	742 707 012			
Module 13	742 707 013			
Module 14	742 707 014			
Module 15	742 707 015			
Module empty	742 707 310			
Module empty with boxes	742 707 310 + 5 x 742 707 405			

 *Small boxes*
 *Small design kits*
 *Large design kits*

αRack



nal extensions *Page 47–52*

STEP 3
Get in touch
with your Würth
Elektronik
sales team



Module	Order Code	
Box assortment	742 707 405	
Wall bracket	742 707 303	
Pedestal set	742 707 306	
Tower 1	742 707 304	
Tower 2	742 707 304 + 742 707 305	
Tower 3	742 707 304 + 2x 742 707 305	

Additional information for STEP 2

- 4 modules fit each tower
- Tower 2 requires 8 modules
- Tower 3 requires 12 modules

Module 01

EMC: Snap Ferrites
742 707 001

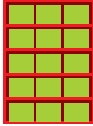



A1		
Order Code	Name	Quantity
742 711 42(S)	STAR-TEC	15

A2		
Order Code	Name	Quantity
742 711 11(S)	STAR-TEC	15
742 711 12(S)		15

A3		
Order Code	Name	Quantity
742 711 31(S)	STAR-TEC	15
742 711 32(S)		15

A4		
Order Code	Name	Quantity
742 712 21(S)	STAR-TEC	12
742 712 22(S)		12

A5		
Order Code	Name	Quantity
742 711 51(S)	STAR-TEC	4
742 712 11(S)		2
742 712 51(S)		1

A6		
Order Code	Name	Quantity
742 721 42	STAR-TEC LFS	3

A7		
Order Code	Name	Quantity
742 721 31	STAR-TEC LFS	15
742 721 32		15

A8		
Order Code	Name	Quantity
742 722 21	STAR-TEC LFS	12
742 722 22		12

A9		
Order Code	Name	Quantity
742 721 51	STAR-TEC LFS	4
742 722 11		2
742 722 51		1

A10		
Order Code	Name	Quantity
742 716 33(S)	STAR-GAP	15
742 716 22(S)		10

A11		
Order Code	Name	Quantity
742 758 12(S)	STAR-BUENO	15
742 758 13(S)		10
742 758 15(S)		8

A12		
Order Code	Name	Quantity
742 715 3(S)	STAR-RING	15
742 715 4(S)		9
742 715 5(S)		6

A13		
Order Code	Name	Quantity
742 724 8	STAR-FLAT	4
742 724 75		3
742 724 6		5
742 724 7		3

A14		
Order Code	Name	Quantity
742 71	STAR-KEY	25
742 771 1	STAR-CLIP	15
742 771 3		15
742 772 2		10

A15		
Order Code	Name	Quantity
CUSTOMIZE YOUR BOX		

Module 02

EMC: Ferrites
742 707 002

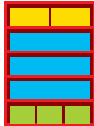



C1	
Name	Design Kit WE-CBF SMALL SIZE
Order Code	742 790

C2	
Name	Design Kit WE-CBF LARGE SIZE
Order Code	742 791

B1	
Name	Design Kit WE-TOF EMI Suppression Toroidal Ferrites
Order Code	742 701

B2	
Name	Design Kit WE-AFB EMI Suppression Axial Ferrite Bead
Order Code	742 700

B3	
Name	Design Kit WE-FLAT Flat Ferrite Cores
Order Code	742 722

A16		
Name	WE-AFB LFS	
Quantity	8	
Order Code	742 772 53	742 772 33
742 725 5	742 772 7	742 772 90
742 772 9		

A17		
Order Code	Name	Quantity
742 700 97	WE-TOF	6
742 701 91		4
742 723 6	WE-FLAT	4

A18		
Order Code	Name	Quantity
742 711 51	STAR-TEC	1
742 712 11		1
742 712 51		1
742 71		5

Module 03

EMC: Common Mode Chokes

742 707 003

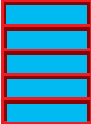



B4	
Name	Design Kit WE-FC / WE-TFC / WE-TFCH Common Mode Power Line Chokes
Order Code	744 864

B5	
Name	Design Kit WE-CMBNC Common Mode Power Line Choke
Order Code	744 800

B6	
Name	Design Kit WE-CMB & WE-CMB NiZn Common Mode Power Line Choke
Order Code	744 821

B7	
Name	Design Kit SMD Common Mode Filters for Data Lines
Order Code	744 725

B8	
Name	Design Kit WE-LF Common Mode Power Line Choke
Order Code	744 630

Module 04

EMC: Ferrites/Varistors/Shielding
742 707 004

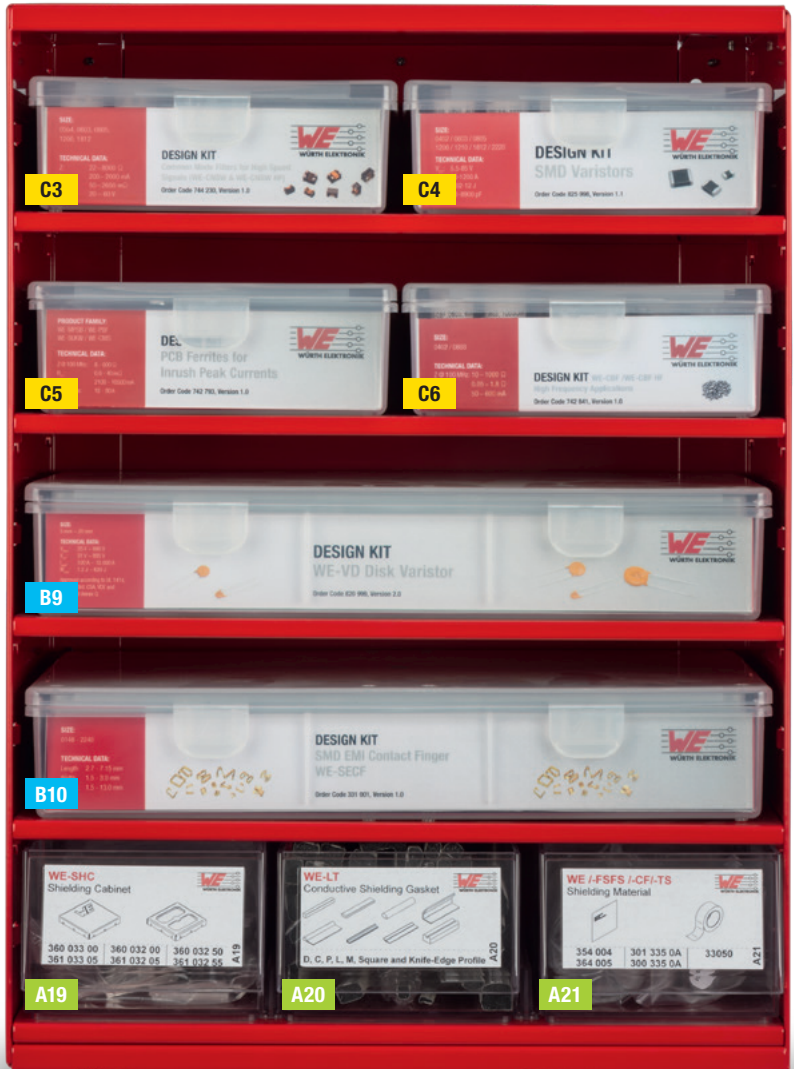
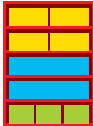



C3	
Name	Design Kit WE-CNSW & WE-CNSW HF
Order Code	744 230

C4	
Name	Design Kit WE-SMD Varistors
Order Code	825 998

C5	
Name	Design Kit PCB Ferrites for Inrush Peak Currents
Order Code	742 793

C6	
Name	Design Kit WE-CBF HF
Order Code	742 841

B9	
Name	Design Kit WE-Disk Varistors
Order Code	820 999

B10	
Name	Design Kit EMI Contact Finger WE-SECF
Order Code	331 001

A19		
Order Code	Name	Quantity
360 033 00	WE-SHC	10
361 033 05		
360 032 00		
361 032 05		
360 032 50		
361 032 55		

A20		
Name	WE-LT	
Order Code	302 050 5	302 080 3
302 100 7	303 020 2	303 040 31
303 080 6	309 141 8	308 180 4
381 110 27	382 056 03	383 130 95
Quantity	(20 cm) 1	

A21		
Order Code	Name	Quantity
354 004	WE-FSFS	5
364 005		5
301 335 0A	WE-CF	(8 cm) 5
300 335 0A		(8 cm) 5
330 50	WE-TS	(8 cm) 5

Module 05

Power Elements / Assembly / Switches

742 707 005





B11	
Name	Design Kit Power Elements
Order Code	746 701

B12	
Name	Design Kit Tubular Cable Lugs, Standard
Order Code	558 001

B13	
Name	Design Kit Assembly Technique
Order Code	700 999

B14	
Name	Design Kit WA-SMST, WA-SMSI, WA-SMSE SMD Steel Spacer
Order Code	977 990

B15	
Name	Design Kit Switches
Order Code	499 001

Module 06

WE-MLCC

742 707 006





B16	
Name	Design Kit WE-WCAP-CSGP Multilayer Ceramic Chip Capacitors 0402
Order Code	885 050

B17	
Name	Design Kit WE-WCAP-CSGP Multilayer Ceramic Chip Capacitors 0603
Order Code	885 060

B18	
Name	Design Kit WE-WCAP-CSGP Multilayer Ceramic Chip Capacitors 0805
Order Code	885 070

B19	
Name	Design Kit WE-WCAP-CSGP Multilayer Ceramic Chip Capacitors 1206/1210/1812
Order Code	885 080

B20	
Name	Design Kit WCAP-CSGP Multilayer Ceramic Chip Capacitors 100V
Order Code	885 090

Module 07

THT- / SMD-Capacitors

742 707 007

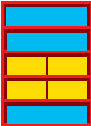



B21	
Name	Design Kit WE-WCAP-FTX2 MKP Film Capacitors X2 275 V AC
Order Code	890 324

B22	
Name	Design Kit WE-WCAP-FTXX
Order Code	890 334

C7	
Name	Design Kit WE-WCAP-CSSA
Order Code	885 300

C8	
Name	
Order Code	

C9	
Name	WCAP-CSMH Mid and High Voltage MLCC 200V-600V
Order Code	885 341

C10	
Name	WCAP-CSMH Mid and High Voltage MLCC 1000V-3000V
Order Code	885 342

B23	
Name	
Order Code	

Module 08

THT Power Inductors WE-TI/WE-TIS
742 707 008





B24	
Name	Design Kit WE-TI Radial Leaded Wire Wound Inductor
Order Code	744 741

B25	
Name	Design Kit WE-TI Radial Leaded Wire Wound Inductor
Order Code	744 743

B26	
Name	Design Kit WE-TIS Shielded Radial Leaded Wire Wound Inductor
Order Code	744 731

B27	
Name	
Order Code	

B28	
Name	
Order Code	

Module 09

SMD: Power Inductors WE-TPC/WE-SPC
742 707 009

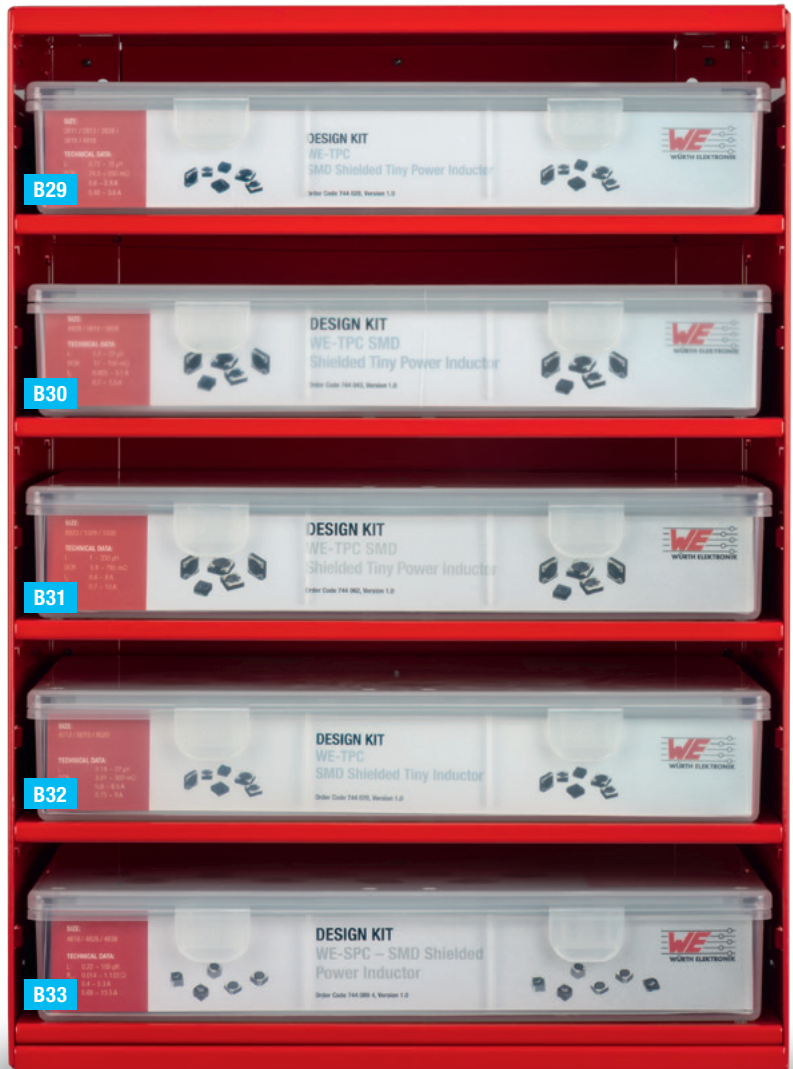



B29	
Name	Design Kit WE-TPC SMD Shielded Tiny Inductor 2811/2813/2828/3510/3816/4818
Order Code	744 028

B30	
Name	Design Kit WE-TPC SMD Shielded Tiny Inductor 4828/5818/5828
Order Code	744 043

B31	
Name	Design Kit WE-TPC SMD Shielded Tiny Inductor 6823/1028/1038
Order Code	744 062

B32	
Name	Design Kit WE-TPC SMD Shielded Tiny Inductor 8012/8015/8020
Order Code	744 070

B33	
Name	Design Kit WE-SPC SMD Shielded Power Inductor
Order Code	744 089 4

Module 10

SMD: Power Inductors WE-MAPI/WE-LQS/WE-PMI
742 707 010

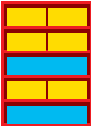



C11	
Name	Design Kit WE-MAPI Metal Alloy Power Inductor 1610/2010
Order Code	744 383 1

C12	
Name	Design Kit WE-MAPI Metal Alloy Power Inductor 2506/2508/2510/2512
Order Code	744 383 2

C13	
Name	Design Kit WE-MAPI Metal Alloy Power Inductor 3010/3012/3015/3020
Order Code	744 383 3

C14	
Name	
Order Code	

B34	
Name	Design Kit WE-LQS Semi-Shielded Power Inductor 5040/6028/6045/8040
Order Code	744 040 5

C15	
Name	Design Kit WE-PMI SMD Power Multilayer Inductors 0603/0805/0806/1008/1210
Order Code	744 797

C16	
Name	Design Kit WE-LQS Semi-Shielded Power Inductor 2010/2512/3015
Order Code	744 040 2

B35	
Name	
Order Code	

Module 11

SMD: High Current Inductors WE-HCC/WE-HCM/WE-HCF
742 707 011





B36	
Name	Design Kit WE-HCC SMD High Current Cube Inductor 8070/1090/1210
Order Code	744 332

B37	
Name	Design Kit WE-HCM High Current Flat Wire Inductor 7050/7070/1050/1070/1052/1190/1240/1350/1390
Order Code	744 300

B38	
Name	Design Kit WE-HCF SMD High Current Inductor 2013/2818
Order Code	744 363

B39	
Name	
Order Code	

B40	
Name	
Order Code	

Module 12

SMD: High Current Inductors WE-HCI
742 707 012





B41	
Name	WE-HCI SMD Flat Wire High Current Inductors 7030/7040/7050
Order Code	744 354

B42	
Name	WE-HCI SMD Flat Wire High Current Inductors 1890
Order Code	744 357

B43	
Name	WE-HCI SMD Flat Wire High Current Inductors 1030/1040/1050
Order Code	744 355

B44	
Name	WE-HCI SMD Flat Wire High Current Inductors 1335/1350/1360
Order Code	744 356

B45	
Name	
Order Code	

Module 13

SMD: Power Inductors WE-LHMI/WE-PD
742 707 013

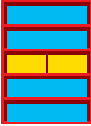



B46	
Name	Design Kit WE-LHMI SMD Low Profile High Current Molded Inductor 1040/1335
Order Code	744 373 6

B47	
Name	Design Kit WE-LHMI SMD Low Profile High Current Molded Inductor 7030/7050
Order Code	744 373 4

C17	
Name	Design Kit WE-LHMI SMD Low Profile High Current Molded Inductor 5020/5030
Order Code	744 373 5

C18	
Name	
Order Code	

B48	
Name	Design Kit WE-PD SMD Shielded Power Inductor 1030/1050
Order Code	744 771 3

B49	
Name	Design Kit WE-PD SMD Shielded Power Inductor 1210/1280
Order Code	744 770

Module 14

Automotive Standard Products

742 707 014

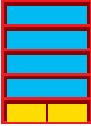



B50	
Name	Design Kit WE-PDA SMD Power Inductor 1260/1280/1210
Order Code	784 770

B51	
Name	Design Kit WE-PDA SMD Power Inductor 7332/7345
Order Code	784 778

B52	
Name	Design Kit WE-PD2A SMD Power Inductor 7850/1054
Order Code	784 775

B53	
Name	Design Kit WE-PD2A SMD Power Inductor 4532/5820/5848
Order Code	784 773

C19	
Name	Design Kit WE-MAIA Metal Alloy Power Inductor 3010/3012/3015
Order Code	784 383 3

C20	
Name	Design Kit WE-MAIA Metal Alloy Power Inductor 2506/2508/2510
Order Code	784 383 2

Module 15

EMC: Line Filters

742 707 015

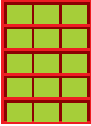



A22		
Order Code	Name	Quantity
810 911 001	WE-CLFS	3
742 707 322	BLADE RECEPTACLE	100
742 707 323		100
742 707 324		100

A23		
Order Code	Name	Quantity
810 911 003	WE-CLFS	3
810 911 006		3

A24		
Order Code	Name	Quantity
810 911 008	WE-CLFS	3
810 911 010		3

A25		
Order Code	Name	Quantity
810 912 001	WE-CLFS	3

A26		
Order Code	Name	Quantity
810 912 003	WE-CLFS	3

A27		
Order Code	Name	Quantity
810 912 006	WE-CLFS	3

A28		
Order Code	Name	Quantity
810 912 008	WE-CLFS	3

A29		
Order Code	Name	Quantity
810 912 010	WE-CLFS	3

A30		
Order Code	Name	Quantity
810 912 012	WE-CLFS	3

A31		
Order Code	Name	Quantity
810 912 014	WE-CLFS	3

A32		
Order Code	Name	Quantity
810 912 020	WE-CLFS	3

A33		
Order Code	Name	Quantity
810 913 006	WE-CLFS	2

A34		
Order Code	Name	Quantity
810 913 010	WE-CLFS	2

A35		
Order Code	Name	Quantity
810 913 014	WE-CLFS	2

A36		
Order Code	Name	Quantity
810 913 020	WE-CLFS	2

Empty modules & empty modules with boxes

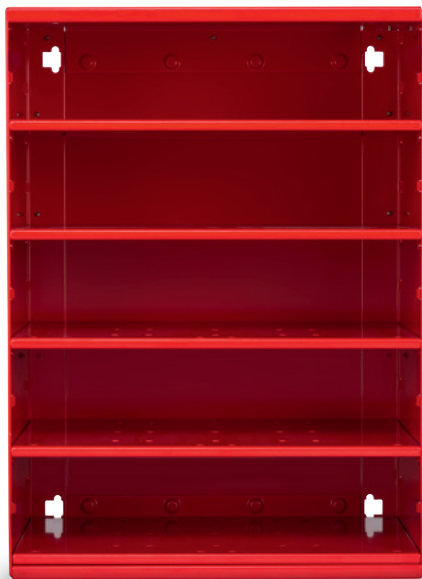

Module empty

742 707 310



Module empty with boxes

742 707 310 +
5x 742 707 405

Box assortment

Optional assembly accessories

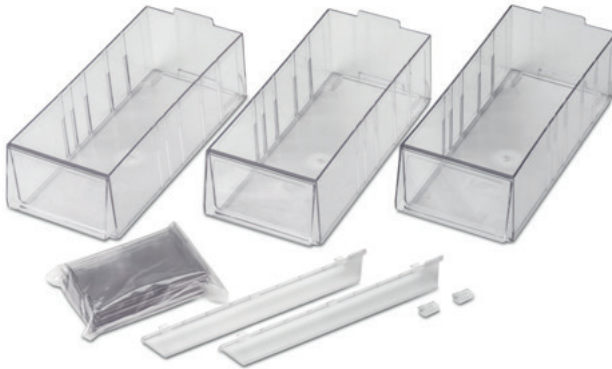

Box Assortment

742 707 405

Box assortment for your own α Rack configuration

- 3 x large boxes for α Rack
- 9 x separators for the large α Rack box
- 2 x slide rails for α Rack
- 2 x snap fittings for α Rack

Why more boxes?

- More components
- Organizational system with label
- Boxes are stackable

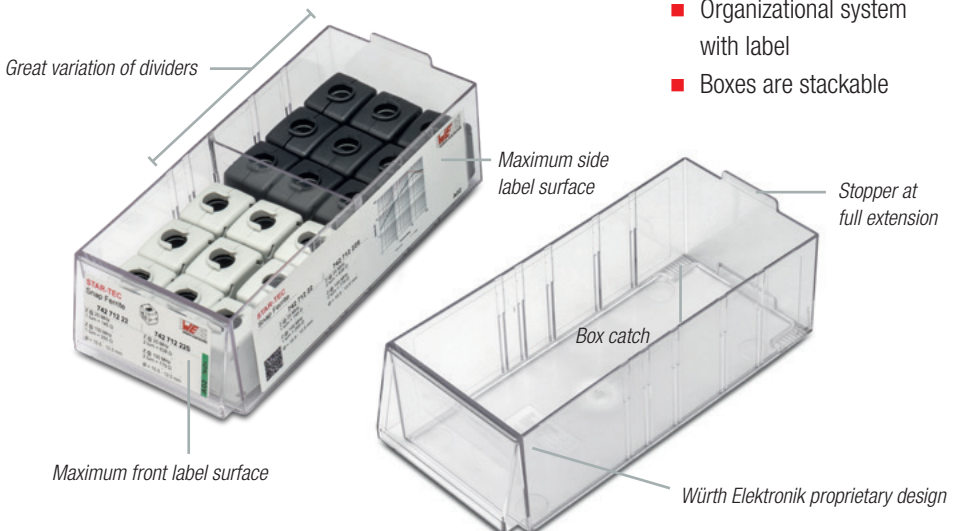

Expandability



Your **α**Rack can grow!

Tower 1:

Required components



Tower 1

742 707 304 + Modules (742 707 XXX)

- Four modules are required
- Choose any modules



Example configuration Module 1 to 4

Combinations	Individual part name	Required article numbers	Quantity
Tower 1	Modules	742 707 XXX	4
	Rotating tower base	742 707 304	1

Optional: Can be ordered with pedestals!



Pedestal set

742 707 306

Tower 2:

Required components



Tower 2

**742 707 304 + 742 707 305 +
Modules (742 707 XXX)**

- Eight modules are required
- Choose any modules

*Example configuration Module 1 to
4 plus "Module empty"*

Combinations	Individual part name	Required article numbers	Quantity
Tower 2	Modules	742 707 XXX	8
	Rotating tower base	742 707 304	1
	Level add-on	742 707 305	1

Optional: Can be ordered with pedestals!



Pedestal set

742 707 306

Tower 3:

Required components



Tower 3

**742 707 304 + 2 x 742 707 305 +
Modules (742 707 XXX)**

- 12 modules are required
- Choose any modules

*Example configuration Module 1
to 4 plus "Module empty"*

Combinations	Individual part name	Required article numbers	Quantity
Tower 3	Modules	742 707 XXX	12
	Rotating tower base	742 707 304	1
	Level add-on	742 707 305	2

Optional: Can be ordered with pedestals!



Pedestal set

742 707 306

Pedestal set



Pedestals set

742 707 306

- Place the αRack on a table or on the floor
- Simple assembly
- Convenient handling of components
- Compatible with all towers



Dimensions of α Rack Tower



α Towers

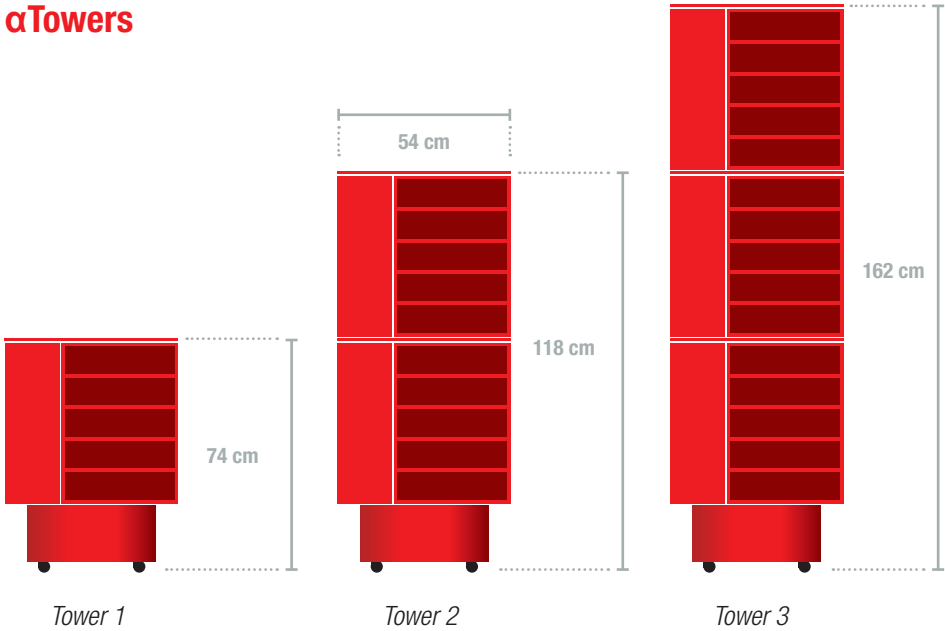

Modules

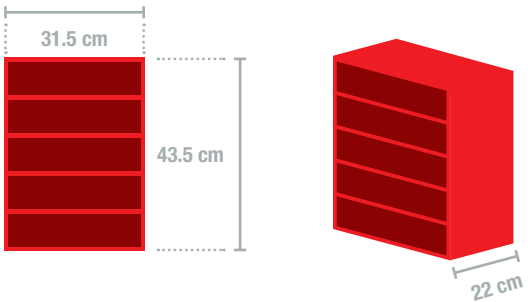

Wall bracket for α Rack

Wall bracket

742 707 303

- Two α Racks can be attached to a wall bracket
- Seamless expansion possible!
- Fast, simple mounting



Assembly instruction Wall bracket for α Rack



Mark drill holes

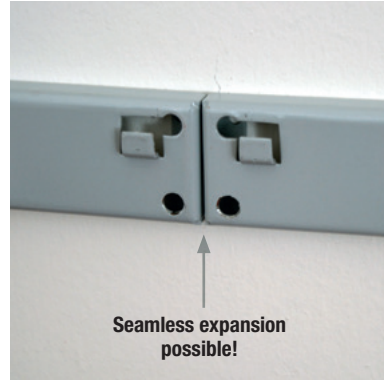

Drill holes and attach wall brackets



Attach spacer



Mounting

Assembly instruction for α Rack Tower 1–3



Base preparation



Tower 1 without cover



*Short threaded rod is always inserted
into the top level*



*Level add on Tower 2–3 and
cover assembly*

Double open-ended wrench 13x17 > including



Allenkey 6x90 > including



Assembly instruction valid for Tower base 1–3



Note: the short threaded rods (A) will only be used on the base for level 1 Tower

1. Unscrew hex bolt



Step 1

Screw in threaded rod until flush

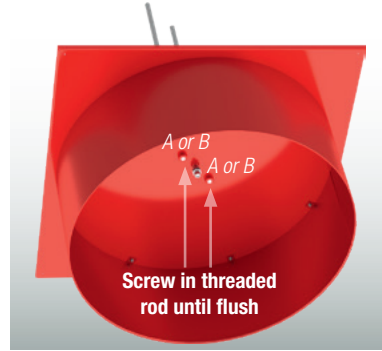

Step 2

1. Screw in hex bolt again



Step 3

A Threaded rods, short



B Threaded rods, long



C 1 x M8 hex bolt



E 2 x M10 Hex nut



Assembly instruction for Tower 1

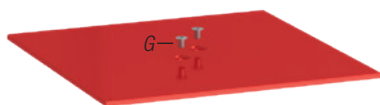

A Threaded rods, short



E 2x M10 Hex nut



F 1x Spacer



G 2x M10 Round washer



Assembly instruction for Tower 2–3

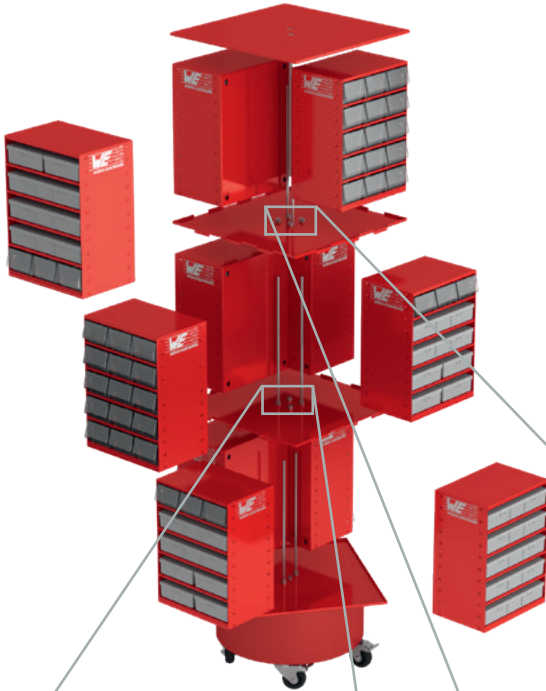

D M10 Washer



E M10 Hex nut

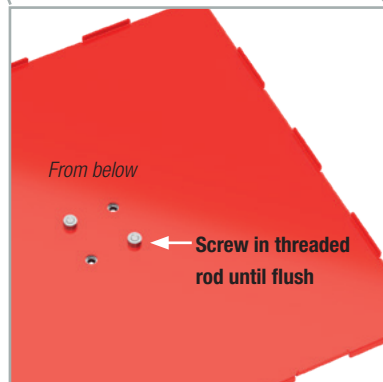
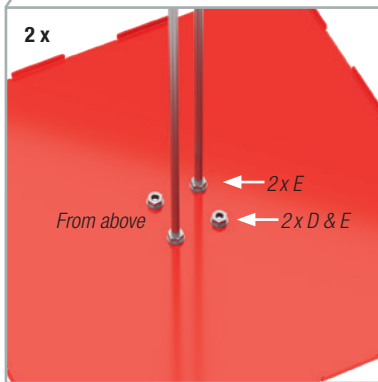

Assembly instruction for Tower 2



A 2x Threaded rods, short



B 2x Threaded rods, long



D 2x M10 Washer E 6x M10 Hex nut



F 1x Spacer



G 2x M10 Round washer



Assembly instruction for Tower 3



A 2x Threaded rods, short



B 4x Threaded rods, long



D 4x M10 Washer E 10x M10 Hex nut



F 1x Spacer



G 2x M10 Round washer







Ω Rack

Ω Rack variants





ΩRack benefits

The measure of all things

- Organizational system for components, design kits and documents
- All technical information at a glance
- Large selection of components and design kits
- Twice as many products
- Custom racks can be ordered



Let's order, but how ...?

STEP 1

Select rack type

You'd like to have everything!

	Name	Part number	Quantity
3 Racks Complete	ΩRack Coverage	742 707 500	3
	ΩRack Base	742 707 501	2
	ΩRack Shelf box size 3	742 707 503	2
	ΩRack Shelf box size 4	742 707 504	1
	ΩRack Double shelf	742 707 502	4
	ΩRack Drawer unit	742 707 505	1
	ΩRack Foam	742 707 506	8
	ΩRack assembly EMC 1	742 707 101	1
	ΩRack assembly EMC 2	742 707 102	1
	ΩRack assembly EMC 3	742 707 103	1
	ΩRack assembly EMC 4	742707104	1

Please order all article numbers with the quantity indicated in the table if you want to have all 3 racks, including Module 1 components.

You'd like only the empty racks!

	Name	Part number	Quantity
Module 1 empty¹	ΩRack Coverage	742 707 500	1
	ΩRack Base	742 707 501	1
	ΩRack Shelf box size 3	742 707 503	2
	ΩRack Shelf box size 4	742 707 504	1
Module 2 empty²	ΩRack Coverage	742 707 500	1
	ΩRack Double shelf	742 707 502	3
	ΩRack Base	742 707 501	1
	ΩRack Foam	742 707 506	6
Module 3 empty²	ΩRack Coverage	742 707 500	1
	ΩRack Double shelf	742 707 502	1
	ΩRack Drawer unit	742 707 505	1
	ΩRack Foam	742 707 506	2

Please order all article numbers with the quantity indicated in the table for each empty rack you'd like to have.

¹ See next page for information on stocking Module 1

² No stock necessary

STEP 2

Select addit



αRack



ional extensions

Would you like to have additional stock?

	Name	Part number	Quantity
Assembly module 1	ΩRack with EMC 1	742 707 101	1
	ΩRack with EMC 2	742 707 102	1
	ΩRack with EMC 3	742 707 103	1
	ΩRack with EMC 4	742 707 104	1

See next page for detailed information about stocking Module 1.

STEP 3
Get in touch
with your Würth
Elektronik
sales team



EMC 1



EMC 2



EMC 3



EMC 4



Details about stocking Module 1

EMC 1 – 742 707 101			
Box	Part number	Name	Pieces
01	742 711 42(S)	STAR-TEC	50
	742 711 11(S)	STAR-TEC	30
02	742 711 12(S)		30
	03	742 711 31(S)	STAR-TEC
742 711 32(S)			30
04	742 712 21(S)	STAR-TEC	20
	742 712 22(S)		20
05	742 711 51(S)	STAR-TEC	6
	742 712 11(S)		5
	742 712 51(S)		4
06	742 721 42	STAR-TEC LFS	50

EMC 2 – 742 707 102			
Box	Part number	Name	Pieces
07	742 721 31	STAR-TEC LFS	30
	742 721 32		30
08	742 722 21	STAR-TEC LFS	20
	742 722 22		20
09	742 721 51	STAR-TEC LFS	6
	742 722 11		5
	742 722 51		4
10	742 716 33(S)	STAR-GAP	30
	742 716 22(S)		20
11	742 758 12(S)	STAR-BUENO	30
	742 758 13(S)		20
	742 758 15(S)		20
12	742 715 3(S)	STAR-RING	30
	742 715 4(S)		20
	742 715 5(S)		15

EMC 3 – 742 707 103			
Box	Part number	Name	Pieces
P1	742 701 716	WE-TOF	40
	742 701 10		30
P2	742 701 707	WE-TOF	30
	742 700 97		6
P3	742 701 98	WE-TOF	6
	742 701 91		4
P4	742 723 6	WE-FLAT	4
	742 700 790	WE-AFB	12
P5	742 772 90	WE-AFB LFS	12
	742 772 9		20

EMC 3 – 742 707 103			
Box	Part number	Name	Pieces
P6	742 772 53	WE-AFB LFS	20
	742 772 55		20
P7	742 772 33	WE-AFB LFS	40
	742 772 7		24
P8	364 101 4	WE-FSFS	10
	364 105		10
	374005		10
	300 335 0A	WE-CF	1 m
	301 335 0A		1 m
P9	330 50	WE-TS	1 m
	394 200 01	WE-FAS TC	5
	344 105 001	WE-FAS EMI	15
	344 130 01		15
	344 150 01		15
P10	390 110 C00 4	WE-LS	10
	306 64S	WE-GS	1 m
P11	361 033 05S	WE-SHC	30
	360 033 00S		30
P12	369 033 05S	WE-SHC	30
	742 737 11	WE-EEL	5
	742 510 4		5
	360 002		WE-ShieldDIY

EMC 3 – Additional recommended Design Kits	
Part number	Name
742 700	Design Kit WE-AFB EMI Suppression Axial Ferrite Bead
742 701	Design Kit WE-TOF EMI Suppression Toroidal Ferrite
742 722	Design Kit WE-FLAT Flat Ferrite Core

Please order these Design Kits additionally if required!

EMC 4 – 742 707 104			
Box	Part number	Name	Pieces
013	742 724 8	STAR-FLAT	9
	742 724 75		8
	742 724 6		9
	742 724 7		8
014	742 71	STAR-KEY	40
	742 771 1	STAR-CLIP	30
	742 771 3		30
	742 772 2		30
015	Customize your box		

Ω Rack dimensions



Combinations



----- Separation of different parts

Nr.	Name	Part number
1	ΩRack Coverage	742 707 500
2	ΩRack Shelf box size 3	742 707 503
3	ΩRack Shelf box size 4	742 707 504
4	ΩRack Double shelf	742 707 502
5	ΩRack Drawer unit	742 707 505
6	ΩRack Foam	742 707 506
7	ΩRack Base	742 707 501



ΩRack parts overview

1 ΩRack Coverage

742 707 500



7 ΩRack Base

742 707 501



2 ΩRack Shelf box size 3

742 707 503



3 ΩRack Shelf box size 4

742 707 504



4 ΩRack Double shelf

742 707 502



5 ΩRack Drawer unit

742 707 505



6 ΩRack Foam

742 707 506



Variation options

Examples for your reference

**Custom options,
create them yourself!**

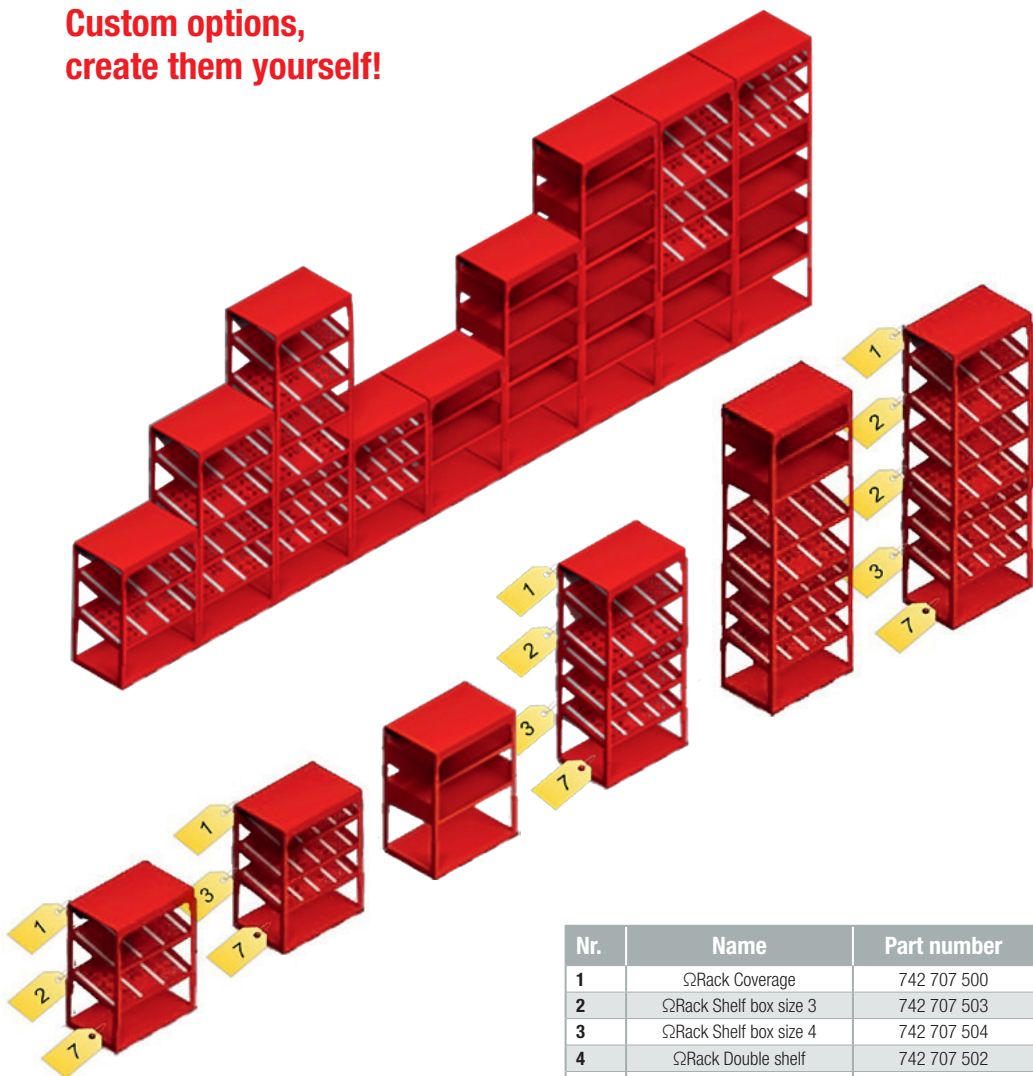

Nr.	Name	Part number
1	ΩRack Coverage	742 707 500
2	ΩRack Shelf box size 3	742 707 503
3	ΩRack Shelf box size 4	742 707 504
4	ΩRack Double shelf	742 707 502
5	ΩRack Drawer unit	742 707 505
6	ΩRack Foam	742 707 506
7	ΩRack Base	742 707 501

Assembly instruction for Ω Rack

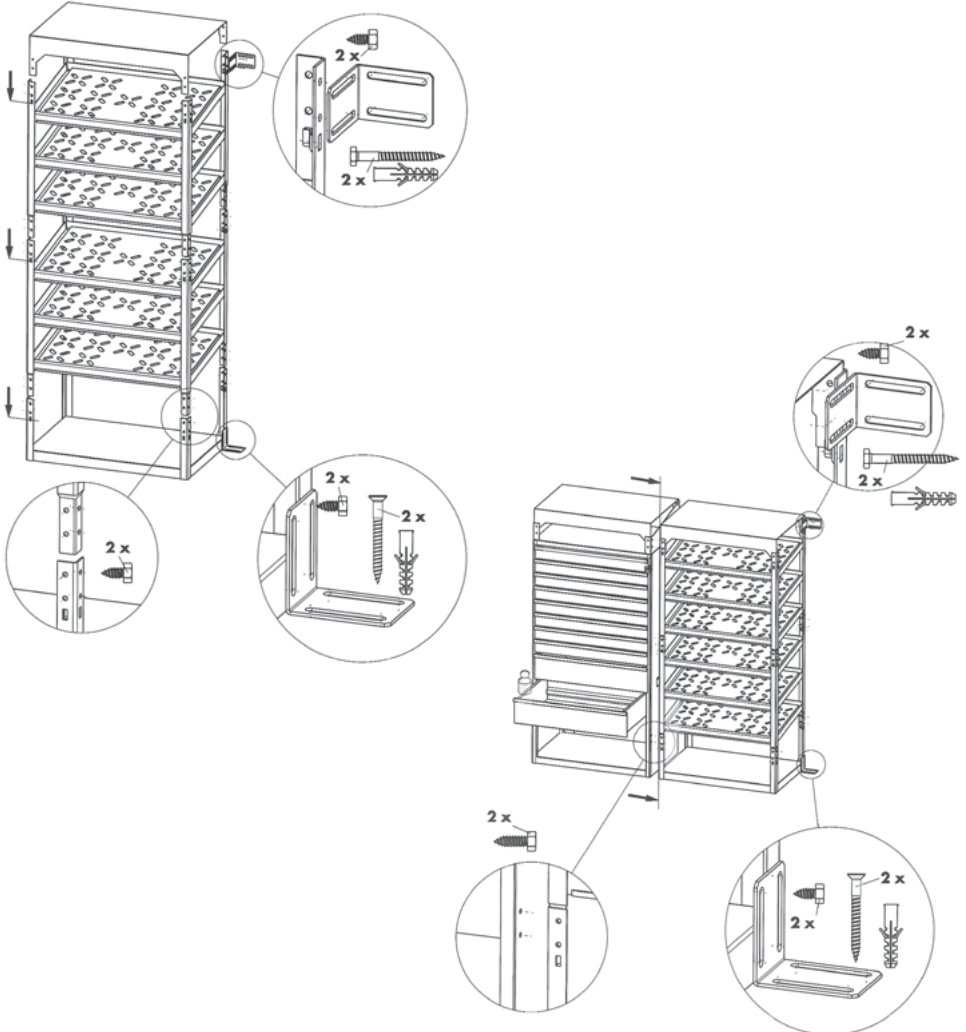

Technical support needed?

Ask our design engineer Lorandt Fölkel



Lorandt Fölkel
Design Engineer
at heart

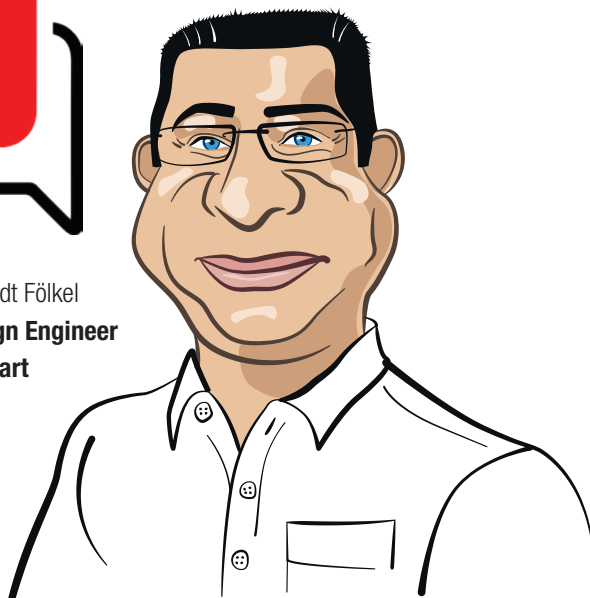

Follow me on ...



twitter.com/askLorandt



linkedin.com/in/lorandtfoelkel



we-online.com/youtube



[we-online.com/askLorandt](mailto:askLorandt@we-online.com)

or contact me directly:

askLorandt@we-online.com

Electronic & Electromechanical Components

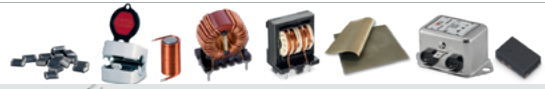

EMC Components



Power Magnetics



Signal & Communications



Quartz & Oscillators



Capacitors



Resistors



Automotive Standard Products



Optoelectronics



Power Modules

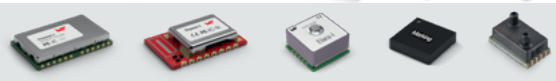

Wireless Connectivity & Sensors



Connectors



Fuseholders



Switches



Assembly Technique



REDCUBE Terminals



more than you expect

Würth Elektronik eiSos differs from all other component manufacturers in several aspects:

- We guarantee all catalogue products are available ex stock
- Samples free of charge
- Orders below MOQ
- Design kits with lifelong free refill
- Design Guide Trilogy of Magnetics, Trilogy of Connectors, Abc of Capacitors, Abc of Power Modules & Application Handbook The LTspice IV Simulator
- Design Seminars free of charge
- Reference designs of leading IC manufacturers
- Worldwide technical sales force and field application engineers on site

