

USER MANUAL

OCEANUS-I

2618011182000

VERSION 1.1

JANUARY 16, 2025

WÜRTH ELEKTRONIK MORE THAN YOU EXPECT

MUST READ

Check for firmware updates

Before using the product, make sure you use the most recent firmware version, data sheet, and user manual. This is especially important for Wireless Connectivity products that were not purchased directly from Würth Elektronik eiSos. A firmware update on these respective products may be required.

We strongly recommend including the possibility of a firmware update in the customer system design.

Revision history

Manual version	Hardware version	Notes	Date
1.0	2.0	<ul style="list-style-type: none">• Initial release of the manual	December 2024
1.1	2.0	<ul style="list-style-type: none">• Correct RX/TX radio switch table in chapter RF switch	January 2025

Abbreviations

Abbreviation	Name
ADC	Analog to Digital Converter
BSP	Board Support Package
BYOF	Build Your Own Firmware
CMOS	Complementary Metal Oxide Semiconductor
DAC	Digital to Analog Converter
ESD	Electrostatic Discharge
EV	Evaluation
FW	Firmware
GND	Ground
GPIO	General Purpose Input Output
HSE	High Speed External Oscillator
I ² C	Inter Integrated Circuit
I/O	Input/Output
JTAG	Joint Test Action Group
LoRaWAN®	Long Range Wide Area Network
LED	Light Emitting Diode
LNA	Low Noise Amplifier
LSE	Low Speed External Oscillator
MCU	Micro Controller Unit
P2P	Peer to Peer
PCB	Printed Circuit Board
PCN	Product Change Notification
RF	Radio Frequency
RTC	Real Time Clock
SDK	Software Development Kit
SPI	Serial Peripheral Interface
SRAM	Static Random Access Memory
SWD	Serial Wire Debug
TCXO	Temperature Compensated Crystal Oscillator
TTL	Transistor Transistor Logic
UART	Universal Asynchronous Receiver Transmitter
UMRF	Ultra Miniature Radio Frequency
VDD	Supply Voltage
WAN	Wide Area Network

Contents

1	Introduction	5
1.1	Block diagram	6
1.2	Ordering information	6
2	Electrical and radio specifications	7
2.1	Recommended operating conditions	7
2.2	Absolute maximum ratings	7
2.3	Power consumption	8
2.4	Radio characteristics	10
2.5	Pin characteristics	11
3	Pinout	12
3.1	RF pin	14
3.1.1	RF switch	14
4	Build Your Own Firmware	16
4.1	Prerequisites:	16
4.2	Further information about the module and development:	16
4.3	Creating an empty project	16
4.3.1	Enabling radio and generating example application	17
4.4	BSP Boardfiles for Oceanus-I	18
4.5	Migrating a STM32WL example to WLE	19
5	Design in guide	20
5.1	Advice for schematic and layout	20
5.2	Designing the antenna connection	22
5.3	Antenna solutions	23
5.3.1	Wire antenna	24
5.3.2	Chip antenna	24
5.3.3	PCB antenna	24
5.3.4	Antennas provided by Würth Elektronik eiSos	24
5.3.4.1	2600130086 - Hermippe-III dipole antenna	25
5.3.4.2	2600130081 - Hyperion-I dipole antenna	26
5.3.4.3	2600130082 - Hyperion-II magnetic base antenna	27
6	Reference design	28
6.1	EV-Board	29
6.1.1	Schematic	29
6.1.2	Layout	30
7	Manufacturing information	32
7.1	Moisture sensitivity level	32
7.2	Soldering	32
7.2.1	Reflow soldering	32
7.2.2	Cleaning	33
7.2.3	Potting and coating	34
7.2.4	Other notations	34

7.3	ESD handling	34
7.4	Safety recommendations	35
8	Product testing	36
8.1	Würth Elektronik eiSos in-house production tests	36
8.2	EMS production tests	36
9	Physical specifications	38
9.1	Dimensions	38
9.2	Weight	38
9.3	Module drawing	39
9.4	Footprint	40
10	Marking	41
10.1	Lot number	41
10.2	General labeling information	42
11	Information for explosion protection	43
12	References	44
13	Important notes	45
14	Legal notice	45
15	License terms	46

1 Introduction

Oceanus-I is a low-power long-range radio module for wireless communication between devices such as control systems, remote controls, sensors etc.

To meet the specific needs and requirements of various applications, custom firmware can be developed using the Oceanus-I hardware. Since Oceanus-I is built on the STM32WLE5CCU6 microcontroller [1] from STMicroelectronics, users can leverage available tools, documentation, and software examples from ST.

The user has the opportunity to develop his own application, using LoRaWAN® or P2P for radio communication. Within a LoRaWAN® network, Oceanus-I takes the role of an end node.

Combining RF with further requirements or devices, like sensors, directly on the Oceanus-I, eliminates the need for an additional host.

The compact 15 x 16 x 3 mm design allows the module to fit into small-size applications. The low power consumption of the Oceanus-I module makes it suitable for battery-powered applications.



The Oceanus-I shares the same hardware platform as the Daphnis-I module. For this reason, Daphnis-I is often referred to in this user manual.

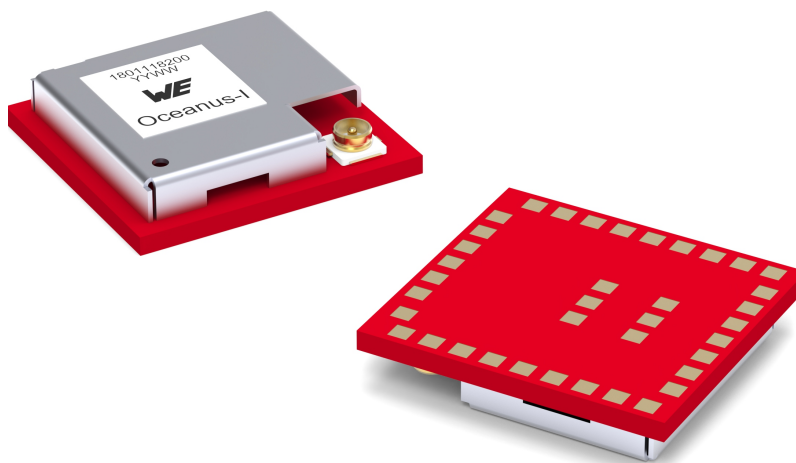

Figure 1: Oceanus-I

1.1 Block diagram

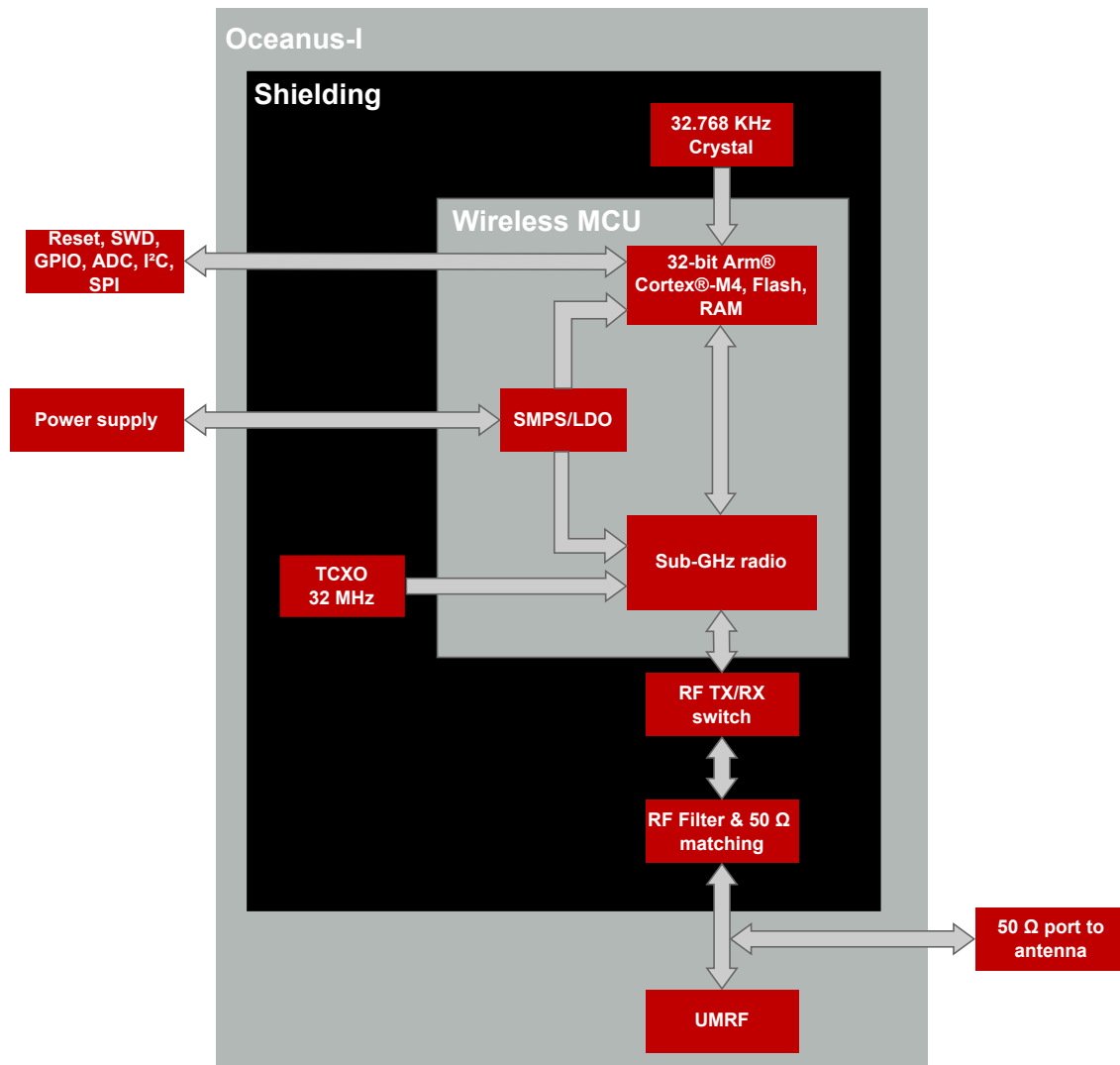

Figure 2: Block diagram

1.2 Ordering information

WE order code	Description
2618011182000	Oceanus-I BYOF module in T&R packaging
2618019382001	EV-Kit with Oceanus-I

Table 1: Ordering information

2 Electrical and radio specifications

Unless stated otherwise, all the values given in the manual were measured on the Daphnis-I EV-Board (same HW platform with Daphnis-I standard firmware) with the following conditions: T = 25 °C, VDD= 3.3 V, PER 1%, 868.3 MHz and internal DCDC in use.

2.1 Recommended operating conditions

Parameter	Direction	Min.	Typ.	Max.	Unit
Supply voltage (VDD)	Supply	2.0	3.3	3.6	V
Operating temperature		-40	25	85	°C

Table 2: Recommended operating conditions

2.2 Absolute maximum ratings

Parameter	Min.	Max.	Unit
Supply voltage (VDD)	-0.3	+3.9	V
Voltage on any digital pin	-0.3	+3.9	V
Input RF level when in RX operation mode		0	dBm
Flash endurance	10 000		write/erase cycles

Table 3: Absolute maximum ratings

2.3 Power consumption

Description	Test conditions	Typ.	Unit
TX current consumption	50 Ω load, +14 dBm output power configuration, 868.3 MHz, LoRa® (SF12, BW 125 kHz)	26.5	mA
RX current consumption	50 Ω load, LNA on, LoRa® (SF12, BW 125 kHz)	6.9	mA
Stop 2 mode current consumption	RTC enabled, full SRAM and peripheral retention	1.5	μA
Shutdown mode current consumption	RTC disabled, backup registers retained	63.9	nA

Table 4: Current consumption

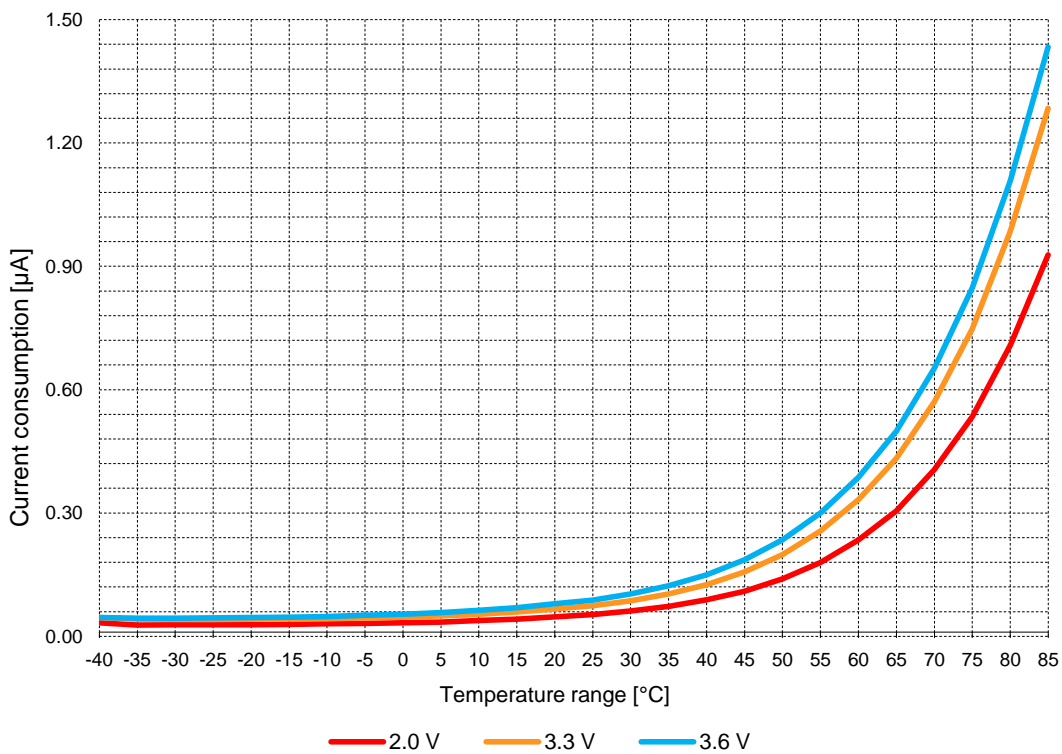

Figure 3: Current consumption during Shutdown mode

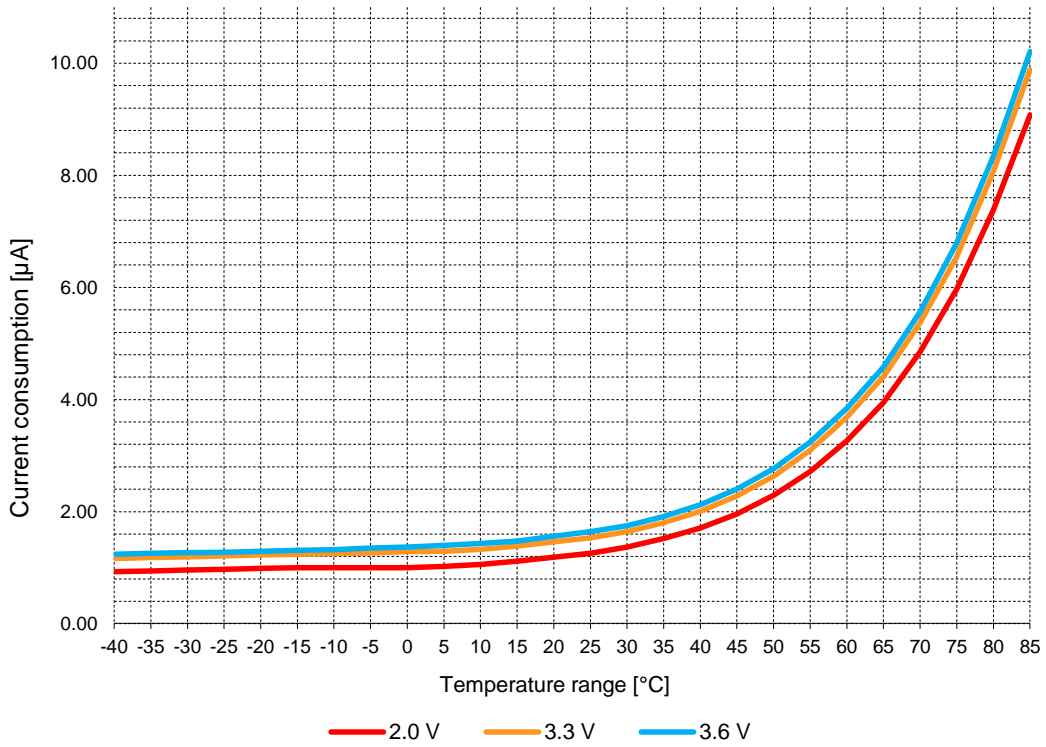

Figure 4: Current consumption during Stop 2 mode

2.4 Radio characteristics

The following factors and tasks are critical for the performance of the Oceanus-I module:

- External antenna for signal reception and transmission,
- RF trace delivering the signal from the external antenna to the RF pad of the Oceanus-I module,
- Minimization of external and environmental effects.

Description	Min	Typ.	Max	Unit
Frequency band	868.0	868.6	870.0	MHz
TCXO frequency		32		MHz
TCXO frequency tolerance		±2.0		ppm
Radio data rate LoRa®	0.018		62.5	kbit/s
Radio data rate FSK	0.6		300	kbit/s
RX sensitivity				
LoRa® (SF12, BW 125 kHz)		-138.0		dBm
LoRa® (SF7, BW 125 kHz)		-124.6		
LoRa® (SF7, BW 250 kHz)		-121.8		
FSK (50 kbps)		-107.5		
TX power		+13.4		dBm

Table 5: Radio characteristics



The supply voltage of the TCXO is hardwired to *PB0_VDDTCXO* pin of MCU.



Besides frequency bands described in above table, the module can operate in frequencies between 902 MHz and 928 MHz. However, the output power is reduced by about 1.5 dBm due to pass-band filter of the radio front-end.

2.5 Pin characteristics

Pin specifications listed in the table below. For more details, refer to the datasheet of the MCU [1].

Parameter	Min.	Typ.	Max.	Unit
Input high-level voltage	$0.7 \times VDD$		VDD	V
Input low-level voltage			$0.3 \times VDD$	V
Output low-level voltage, 4 mA, 8 mA, 10 mA, $VDD \geq 2.0V$			0.4	V
Output low-level voltage, 20 mA, $VDD \geq 2.7 V$			1.3	V
Output high-level voltage, 4 mA, $VDD \geq 2.0 V$	$VDD-0.45 V$			V
Output high-level voltage, CMOS port, 8 mA, $VDD \geq 2.7 V$	$VDD-0.4 V$			V
Output high-level voltage, TTL port, 8 mA, $VDD \geq 2.7 V$	2.4			V
Output high-level voltage, 20 mA, $VDD \geq 2.7 V$	$VDD-1.3 V$			V
Internal pull-up resistance	25	40	55	k Ω
Internal pull-down resistance	25	40	55	k Ω

Table 6: Pin characteristics

3 Pinout

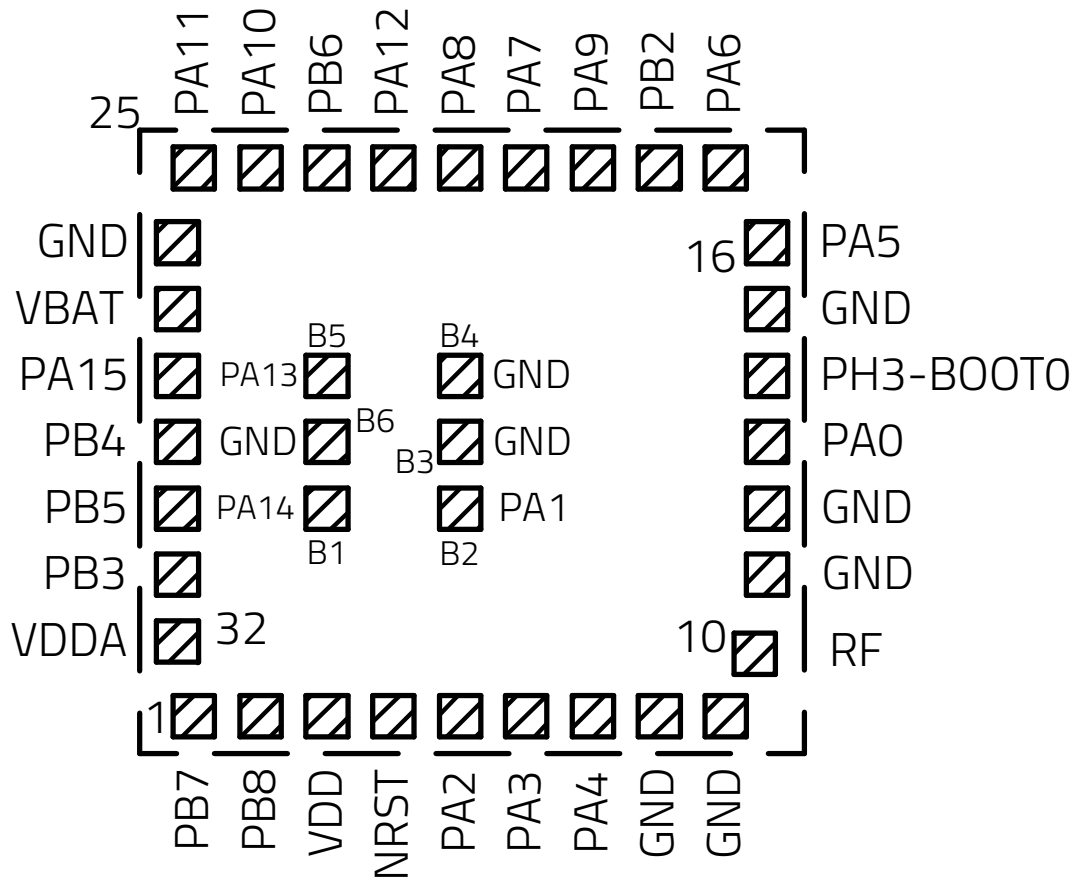

Figure 5: Pinout (top view)

Module Pin Number	Designation	Type	Description
1	<i>PB7</i>	I/O	General purpose I/O
2	<i>PB8</i>	I/O	General purpose I/O
3	<i>VDD</i>	Supply	Supply voltage
4	<i>NRST</i>	Input	Reset
5	<i>PA2</i>	I/O	General purpose I/O
6	<i>PA3</i>	I/O	General purpose I/O
7	<i>PA4</i>	I/O	General purpose I/O
8	<i>GND</i>	Supply	Ground
9	<i>GND</i>	Supply	Ground
10	<i>RF</i>	I/O	50 Ω RF connection through radio front end to transceiver part of chipset
11	<i>GND</i>	Supply	Ground
12	<i>GND</i>	Supply	Ground
13	<i>PA0</i>	I/O	General purpose I/O
14	<i>PH3-BOOT0</i>	I/O	General purpose I/O
15	<i>GND</i>	Supply	Ground
16	<i>PA5</i>	I/O	General purpose I/O
17	<i>PA6</i>	I/O	General purpose I/O
18	<i>PA6</i>	I/O	General purpose I/O
19	<i>PA9</i>	I/O	General purpose I/O
20	<i>PA7</i>	I/O	General purpose I/O
21	<i>PA8</i>	I/O	General purpose I/O
22	<i>PA12</i>	I/O	General purpose I/O
23	<i>PA8</i>	I/O	General purpose I/O
24	<i>PA10</i>	I/O	General purpose I/O
25	<i>PA11</i>	I/O	General purpose I/O
26	<i>GND</i>	Supply	Ground
27	<i>VBAT</i>	Input	Input
28	<i>PA15</i>	I/O	General purpose I/O
29	<i>PB4</i>	I/O	General purpose I/O
30	<i>PB5</i>	I/O	General purpose I/O
31	<i>PB3</i>	I/O	General purpose I/O
32	<i>VDDA</i>	Supply	Supply voltage
B1	<i>PA14</i>	I/O	SWDCLK

B2	<i>PA1</i>	I/O	General purpose I/O
B3	<i>GND</i>	Supply	Ground
B4	<i>GND</i>	Supply	Ground
B5	<i>PA13</i>	I/O	SWDIO
B6	<i>GND</i>	Supply	Ground

Table 7: Pinout



For alternative and additional functions of GPIO pins, check the STM32WLE5CCU6 manual [1].

3.1 RF pin

The *RF* pin provides a 50 Ω RF signal. This pin must be connected to the external antenna via 50 Ω feed line.



If the *RF* pin is used, do not connect any cable or adapter to the UMRF connector.

3.1.1 RF switch

The module features an internal RF switch that toggles between the transmission and reception paths.

RF Switch	STM32WLE5CCU6	Description
VDD	<i>PB12</i>	Supply voltage of RF switch
CTRL	<i>PC13</i>	Controls the path connection

Table 8: Internal pin mapping RF switch to MCU

RF_SW_VCC (PB12)	RF_SW_CTRL1 (PC13)	Description
0	X	Shall be used only if radio is off
1	0	Radio reception
1	1	Radio transmission

Table 9: RX/TX radio switch

4 Build Your Own Firmware

This chapter targets users with advanced experience in STM32Cube IDE, the STM32 chipsets and radio communication. The BYOF approach is not suited for novice and non-advanced firmware developers. In such a case, consider using a standard module Daphnis-I from our product portfolio.

To start with your own firmware development for Oceanus-I, you need a set of information and fulfilled requirements.

4.1 Prerequisites:

- An active account at st.com to access, downloads, middleware and updates
- STM32CubeIDE Tool from ST (tested version 1.16.1)
- STM32Cube_FW_WL package from ST (tested version V1.3.0)
- (optional) STM32CubeMX Tool from ST (tested version 6.12.1)
- Oceanus-I radio module to SoC pin mapping, see table 7

4.2 Further information about the module and development:

- ST documentation (user manuals, programmers guide and data sheet) relevant to the STM32WL chipset, see [1]
- Selected Application Notes from ST: *AN5406*, *AN5408*, *AN5409*, *AN5568*
- ST video tutorial series on how to use STM32CubeIDE for firmware and debugging
- (optional) LoRa® or LoRaWAN®:
All documentation on the LoRa® and LoRaWAN® standard provided by ST and/or the LoRaWAN Alliance, including LoRaWAN® regional parameters.

After installation, the STM32 WL middleware package is located here:

%USERPROFILE%\STM32Cube\Repository\STM32Cube_FW_WL_V1.3.0\

4.3 Creating an empty project

Open STM32CubeIDE and select *File* → *New* → *STM32 Project*. A dialog to select the target board opens. To search for the board, put "STM32WLE5CCU6" as Commercial Part Number. There should be one entry in the MCU/MPU selector tab on the bottom right side. Select the entry and click "Next".

Set the project name and change the workspace settings if required. Otherwise, leave defaults as they are. Click on "Finish" to create the project.

Required software packets will be downloaded to be used for later code creation. This might take a while. Once finished, the project is created and will contain basic drivers for the hardware and a minimal software example. Make sure the IDEs workspace does not contain other active projects.

The project also contains the "ioc" file. It allows easy configuration and code creation using the integrated "Device Configuration Tool". Double-click on the "ioc" file in the project to open the configuration view. Use this view to select and configure the peripherals for the application. Additionally, example code can be generated using certain functionalities of the chip.

4.3.1 Enabling radio and generating example application

The "Categories"-pane to the left lists available hardware and functionalities on the chip. To enable radio communication, open the "Connectivity" section in the "Categories"-pane and select "SUBGHZ". Enable the radio by checking the box "Activated".

Now, radio-specific function are available in the "Middleware and Software Packages"-section. Depending on the use case, select "LORAWAN" or "SUBGHZ_PHY" and enable it by checking the box. Note that only one radio middleware can be enabled at a time.

Once enabled, the radio can be further configured using the "Configuration"-pane. For example, the tab "LoRaWAN application" allows to select a code template (e.g. AT Slave Skeleton or End Node Skeleton). There is further information provided on the required and recommended settings for the selected application right below. Enable the "Information"-pane by clicking on the information button on the upper right within the application-pane.

Enabling and configuring the chip using this view, will add library and source code files to the project, that are provided by ST. These libraries will provide access to APIs needed for the selected functionalities and hardware. Be aware that these libraries are built, provided and maintained by ST. Check the documentation and the ST Community forum for known issues and further support.

In the configuration view perform the following configuration. Details are dependent on the application requirements, so only a very basic setup can be provided here!

- In System Core, RCC: High Speed Clock HSE shall be selected "TCXO"
- In System Core, RCC: Low Speed Clock LSE shall be selected "Crystal/Ceramic Resonator"
- In Connectivity, SUBGHZ: Activated box is checked
- In Middleware: enable exactly one of the radio protocols provided, or enable none and implement your own radio protocol based on the API of SUBGHZ
- In Trace and Debug, Debug: Jtag and trace should select "Serial Wire", for the project's debug configuration



If you want to use LoRa® modulation but not the LoRaWAN® protocol, we recommend using SUBGHZ only and start implementing on that API level without the upper layers provided by ST.

4.4 BSP Boardfiles for Oceanus-I

The BSP files are intended to represent the capabilities on end device level. The Oceanus-I radio module only represents a subsystem with respect to the customers end device.

The specific implementation for the end system shall be derived from STs Nucleo-WL55 BSP files. Users shall import the Nucleo-WL55's BSP files into the project and adopt them according to their application needs. The provided Nucleo WL55 BSP folder is located inside the WL middleware pack:

```
.\Drivers\BSP\STM32WLxx_Nucleo\
```



Caution: Never modify the files in the STM32Cube Repository folder unintentionally.

With respect to the subcomponent radio module it is important to note:

The Oceanus-I implements a HSE of type TCXO 32 MHz, on pin OSC_IN and TCXO VCC is provided by pin PB0.

It has DCDC support and embeds an LSE of type Resonator/Oscillator (32 kHz) on pins PC14 and PC15.

The Oceanus-I implements what the ST drivers and SoC calls "LP" mode for the radio's power amplifier. This setting is hard-wired on the design of the radio module, there is no option to select the "HP" mode with this product. Therefore, the maximum radio TX power in LP mode of the SoC is +15 dBm. Developers must ensure to limit TX power to the value allowed in the radio regulations of the intended markets. They also need to ensure that the application or ST's STM32WL middleware does not select "HP" mode.

The Oceanus-I has a radio switch to control the radio direction. This RX/TX radio switch uses STM32WLE5CCU6 pin PC13 as control pin (RF_SW_CTRL1) and pin PB12 as VDD supply (RF_SW_VCC) to this RF switch. Table 9 describes the levels for this switch, where 0 is the logic level LOW and 1 is logic level HIGH.

For users convenience, the naming RF_SW_CTRL1 and RF_SW_VCC is used since this is the names the Nucleo also uses in the BSP. The radio RX/TX switch used in the module is compatible to the switch in the BSP of the Nucleo WL55 evaluation board.

Developers should ensure that the application can handle and interpret all error states that are send out by the radio and or HAL functions. Most of ST's provided example code does not

implement to handle error states.

Potential buttons, GPIOs, UART, SPI, I²C and LEDs of the end application can be implemented as part of the BSP files.

4.5 Migrating a STM32WL example to WLE

While it is recommended to start new projects as described in the previous chapter, some examples provided by ST cannot be generated using the Device Configuration Tool and are only available for the dual core STM32WL55.

Due to hardware differences in peripherals, the user needs to manually migrate the content of the examples and fix dependencies, so the firmware can run on the single core STM32WLE5. The STM32CubeMX tool supports semi automated import of an example project into an existing ioc file. Pay attention to the details in the import log and yellow warning symbols in the ioc file view after the import.



This procedure involves advanced and manual migration steps by the firmware developer.

A non-exhausted list of steps to import and migrate the project for the single core chip are:

- Create a new CubeMX project for STM32WLE5CCU6 chipset
- Import one of the single core examples of the STM32 WL middleware package
- Check, understand and resolve all warnings and fix them
- Check linker files and start up script and adapt if necessary
- Replace the Nucleo board file with the module specific board file
- Modify the sources of the example to create your application, but be aware that auto code generation will replace your changes unless they are in the user code regions.

5 Design in guide

5.1 Advice for schematic and layout

For users with less RF experience it is advisable to closely copy the relating EV-Board with respect to schematic and layout, as it is a proven design. The layout should be conducted with particular care, because even small deficiencies could affect the radio performance and its range or even the conformity.

The following general advice should be taken into consideration:

- A clean, stable power supply is strongly recommended. Interference, especially oscillation can severely restrain range and conformity.
- Variations in voltage level should be avoided.
- LDOs, properly designed in, usually deliver a proper regulated voltage.
- Blocking capacitors and a ferrite bead in the power supply line can be included to filter and smoothen the supply voltage when necessary.



No fixed values can be recommended, as these depend on the circumstances of the application (main power source, interferences etc.).



The use of an external reset IC should be considered if one of the following points is relevant:



- The slew rate of the power supply exceeds the electrical specifications.
- The effect of different current consumptions on the voltage level of batteries or voltage regulators should be considered. The module draws higher currents in certain scenarios like start-up or radio transmit which may lead to a voltage drop on the supply. A restart under such circumstances should be prevented by ensuring that the supply voltage does not drop below the minimum specifications.
- Voltage levels below the minimum recommended voltage level may lead to malfunction. The reset pin of the module shall be held on LOW logic level whenever the VDD is not stable or below the minimum operating Voltage.
- Special care must be taken in case of battery powered systems.

- Elements for ESD protection should be placed on all pins that are accessible from the outside and should be placed close to the accessible area. For example, the RF-pin is accessible when using an external antenna and should be protected.
- ESD protection for the antenna connection must be chosen such as to have a minimum effect on the RF signal. For example, a protection diode with low capacitance such as the 8231606A or a 68 nH air-core coil connecting the RF-line to ground give good results.
- Placeholders for optional antenna matching or additional filtering are recommended.
- The antenna path should be kept as short as possible.



Again, no fixed values can be recommended, as they depend on the influencing circumstances of the application (antenna, interferences etc.).

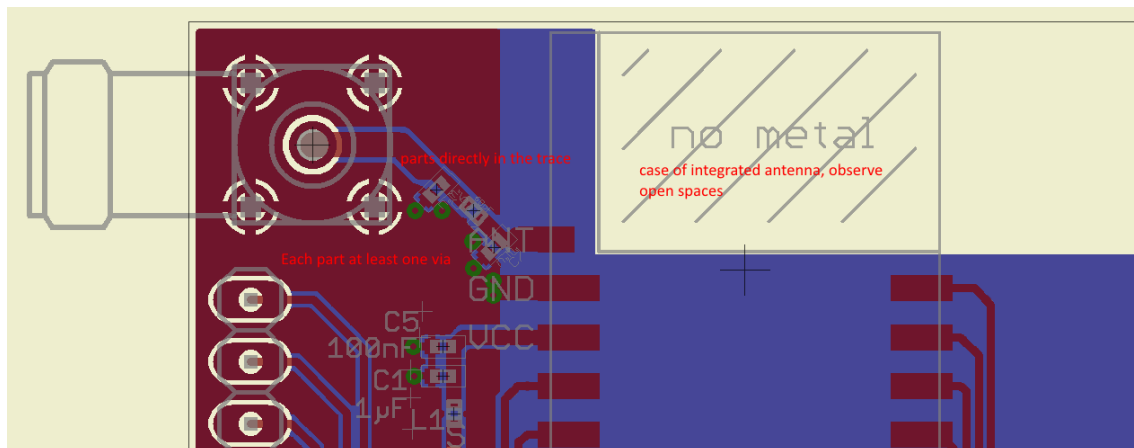

Figure 6: Layout

- To avoid the risk of short circuits and interference there should be no routing underneath the module on the top layer of the baseboard.
- On the second layer, a ground plane is recommended, to provide good grounding and shielding to any following layers and application environment.
- In case of integrated antennas it is required to have areas free from ground. This area should be copied from the EV-Board.
- The area with the integrated antenna must overlap with the carrier board and should not protrude, as it is matched to sitting directly on top of a PCB.
- Modules with integrated antennas should be placed with the antenna at the edge of the main board. It should not be placed in the middle of the main board or far away from the edge. This is to avoid tracks beside the antenna.

- Filter and blocking capacitors should be placed directly in the tracks without stubs, to achieve the best effect.
- Antenna matching elements should be placed close to the antenna / connector, blocking capacitors close to the module.
- Ground connections for the module and the capacitors should be kept as short as possible and with at least one separate through hole connection to the ground layer.
- ESD protection elements should be placed as close as possible to the exposed areas.

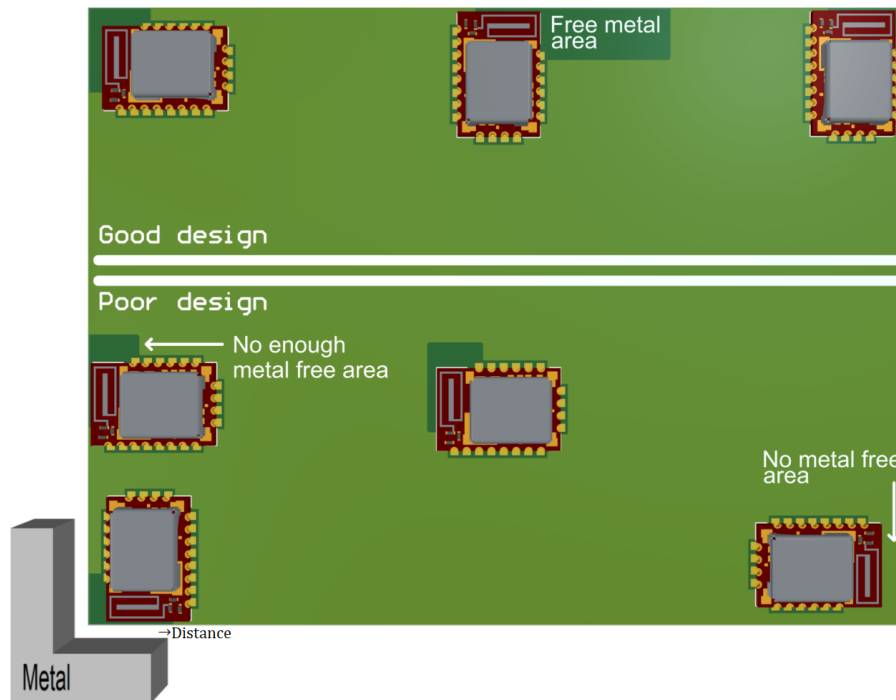

Figure 7: Placement of the module with integrated antenna

5.2 Designing the antenna connection

The antenna should be connected with a 50Ω line. This is needed to obtain impedance matching to the module and avoids reflections. Here we show as an example how to calculate the dimensions of a 50Ω line in form of a micro strip above ground, as this is easiest to calculate. Other connections like coplanar or strip line are more complicated to calculate but can offer more robustness to EMC. There are free calculation tools available in the internet.

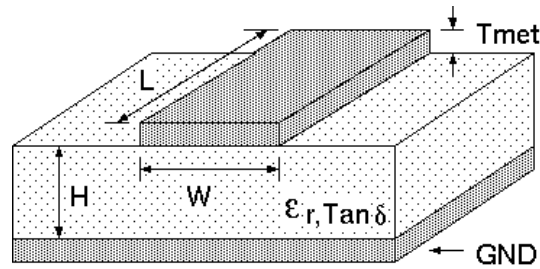

Figure 8: Dimensioning the antenna connection as micro strip

The width W for a micro strip can be calculated using the following equation:

$$W = 1.25 \times \left(\frac{5.98 \times H}{e^{\frac{50 \times \sqrt{\epsilon_r + 1.41}}{87}}} - T_{met} \right) \quad (1)$$

Example:

A FR4 material with $\epsilon_r = 4.3$, a height $H = 1000 \mu\text{m}$ and a copper thickness of $T_{met} = 18 \mu\text{m}$ will lead to a trace width of $W \sim 1.9 \text{ mm}$. To ease the calculation of the micro strip line (or e.g. a coplanar) many calculators can be found in the internet.

- As rule of thumb a distance of about $3 \times W$ should be observed between the micro strip and other traces / ground.
- The micro strip refers to ground, therefore there has to be the ground plane underneath the trace.
- Keep the feeding line as short as possible.

5.3 Antenna solutions

There exist several kinds of antennas, which are optimized for different needs. Chip antennas are optimized for minimal size requirements but at the expense of range, PCB antennas are optimized for minimal costs, and are generally a compromise between size and range. Both usually fit inside a housing.

Range optimization in general is at the expense of space. Antennas that are bigger in size, so that they would probably not fit in a small housing, are usually equipped with a RF connector. A benefit of this connector may be to use it to lead the RF signal through a metal plate (e.g. metal housing, cabinet).

As a rule of thumb a minimum distance of $\lambda / 10$ (which is 3.5 cm @ 868 MHz and 1.2 cm @ 2.44 GHz) from the antenna to any other metal should be kept. Metal placed further away will not directly influence the behavior of the antenna, but will anyway produce shadowing.



Keep the antenna as far as possible from large metal objects to avoid electro-magnetic field blocking.

In the following chapters, some special types of antenna are described.

5.3.1 Wire antenna

An effective antenna is a $\lambda/4$ radiator with a suiting ground plane. The simplest realization is a piece of wire. It's length is depending on the used radio frequency, so for example 8.6 cm 868.0 MHz and 3.1 cm for 2.440 GHz as frequency. This radiator needs a ground plane at its feeding point. Ideally, it is placed vertically in the middle of the ground plane. As this is often not possible because of space requirements, a suitable compromise is to bend the wire away from the PCB respective to the ground plane. The $\lambda/4$ radiator has approximately 40 Ω input impedance. Therefore, matching is not required.

5.3.2 Chip antenna

There are many chip antennas from various manufacturers. The benefit of a chip antenna is obviously the minimal space required and reasonable costs. However, this is often at the expense of range. For the chip antennas, reference designs should be followed as closely as possible, because only in this constellation can the stated performance be achieved.

5.3.3 PCB antenna

PCB antenna designs can be very different. The special attention can be on the miniaturization or on the performance. The benefits of the PCB antenna are their small / not existing (if PCB space is available) costs, however the EV of a PCB antenna holds more risk of failure than the use of a finished antenna. Most PCB antenna designs are a compromise of range and space between chip antennas and connector antennas.

5.3.4 Antennas provided by Würth Elektronik eiSos

Besides the radio modules Würth Elektronik eiSos provides various antennas tailored for the different frequency bands. The recommended single external antennas are shown in the subsequent chapters.



In case integrated multilayer chip antennas are needed because of space limitations, please refer to
<https://www.we-online.com/en/components/products/WE-MCA>.

5.3.4.1 2600130086 - Hermippe-III dipole antenna

Well suited for applications where the RF is lead through a metal wall that could serve as ground plane to the antenna.



Figure 9: Hermippe-III dipole antenna

Specification	Value
Frequency range [MHz]	855 – 915
VSWR (free space, without ground plane)	≤ 2.0
Polarisation	Linear
Impedance [Ω]	50 ± 5
Connector	SMA (Male)
Dimensions (L x d) [mm]	$50 \pm 3 \times 7.92 \pm 0.2$
Weight [g]	4.5
Operating temp. [$^{\circ}\text{C}$]	-40 – +85

5.3.4.2 2600130081 - Hyperion-I dipole antenna



Figure 10: Hyperion-I dipole antenna

Ideally suited for applications where no ground plane is available.

Specification	Value
Center frequency [MHz]	868
Frequency range [MHz]	853 – 883
Wavelength	$\lambda / 2$
VSWR	≤ 2.0
Impedance [Ω]	50
Connector	SMA (Male)
Dimensions (L x d) [mm]	142 x 10
Peak gain [dBi]	-2.3
Operating temp. [$^{\circ}\text{C}$]	-30 – +80

5.3.4.3 2600130082 - Hyperion-II magnetic base antenna

Well suited for applications where the RF is lead through a metal wall that could serve as ground plane to the antenna.



Figure 11: Hyperion-II magnetic base antenna with 1.5 m antenna cable



The 2600130082 is an antenna in form of $\lambda/4$ and therefore needs a ground plane at the feeding point.

Specification	Value
Frequency range [MHz]	824 – 894
VSWR	≤ 2.0
Polarisation	Vertical
Impedance [Ω]	50 ± 5
Connector	SMA (Male)
Dimensions (L x d) [mm]	89.8 x 27
Weight [g]	50 ± 5
Operating temp. [$^{\circ}\text{C}$]	-30 – +60

6 Reference design

Oceanus-I was tested and certified on the corresponding Oceanus-I EV-Board. For the compliance with the EU directive 2014/53/EU Annex I, the EV-Board serves as reference design. This is no discrepancy due to the fact that the EV-Board itself does not fall within the scope of the EU directive 2014/53/EU Annex I as the module is tested on the EV-Board, which is also the recommended use.

Further information concerning the use of the EV-Board can be found in the manual of the Oceanus-I EV-Board.

6.1 EV-Board

6.1.1 Schematic

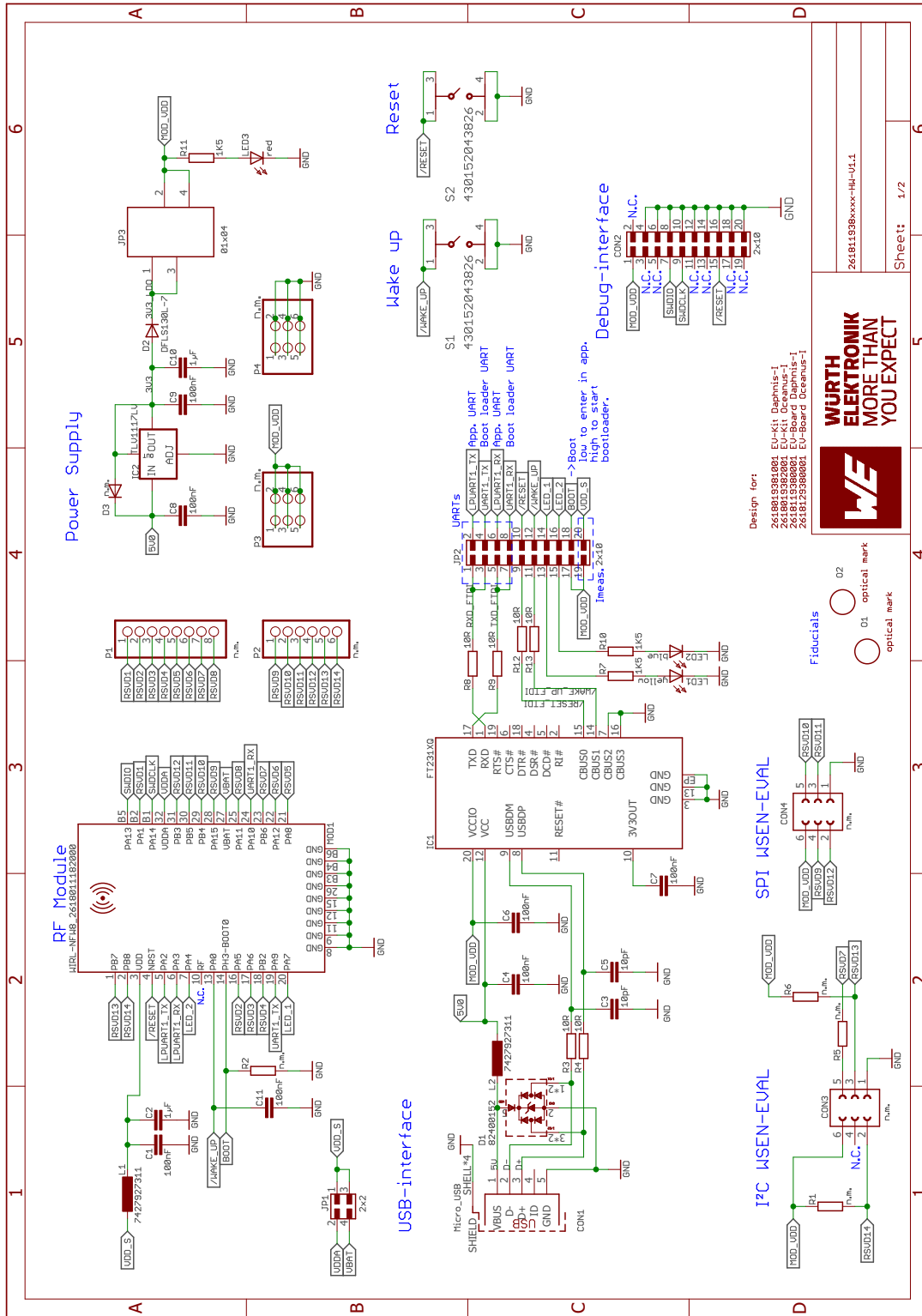

Figure 12: Reference design: Schematic diagram

6.1.2 Layout

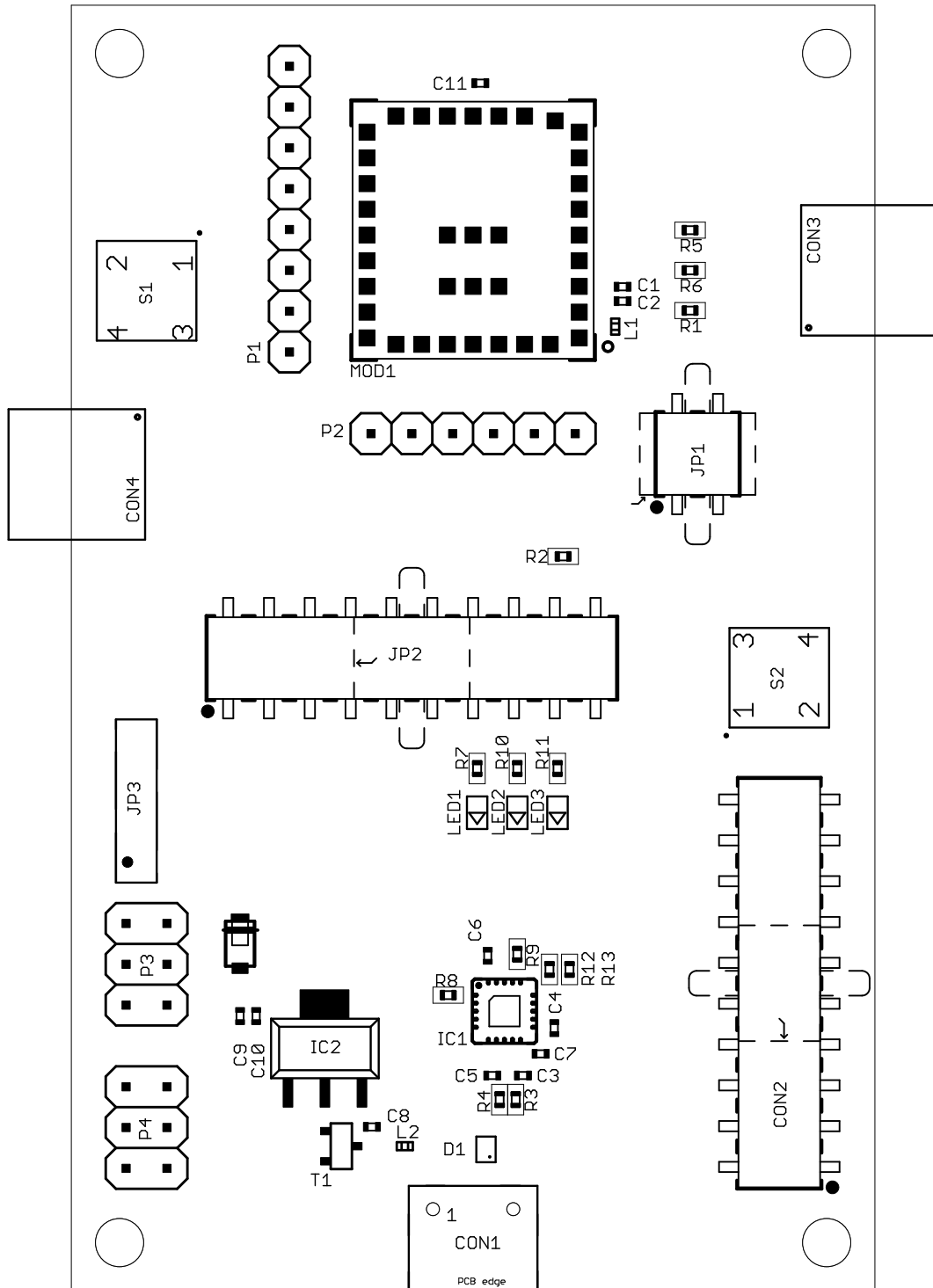

Figure 13: Reference design: Assembly diagram

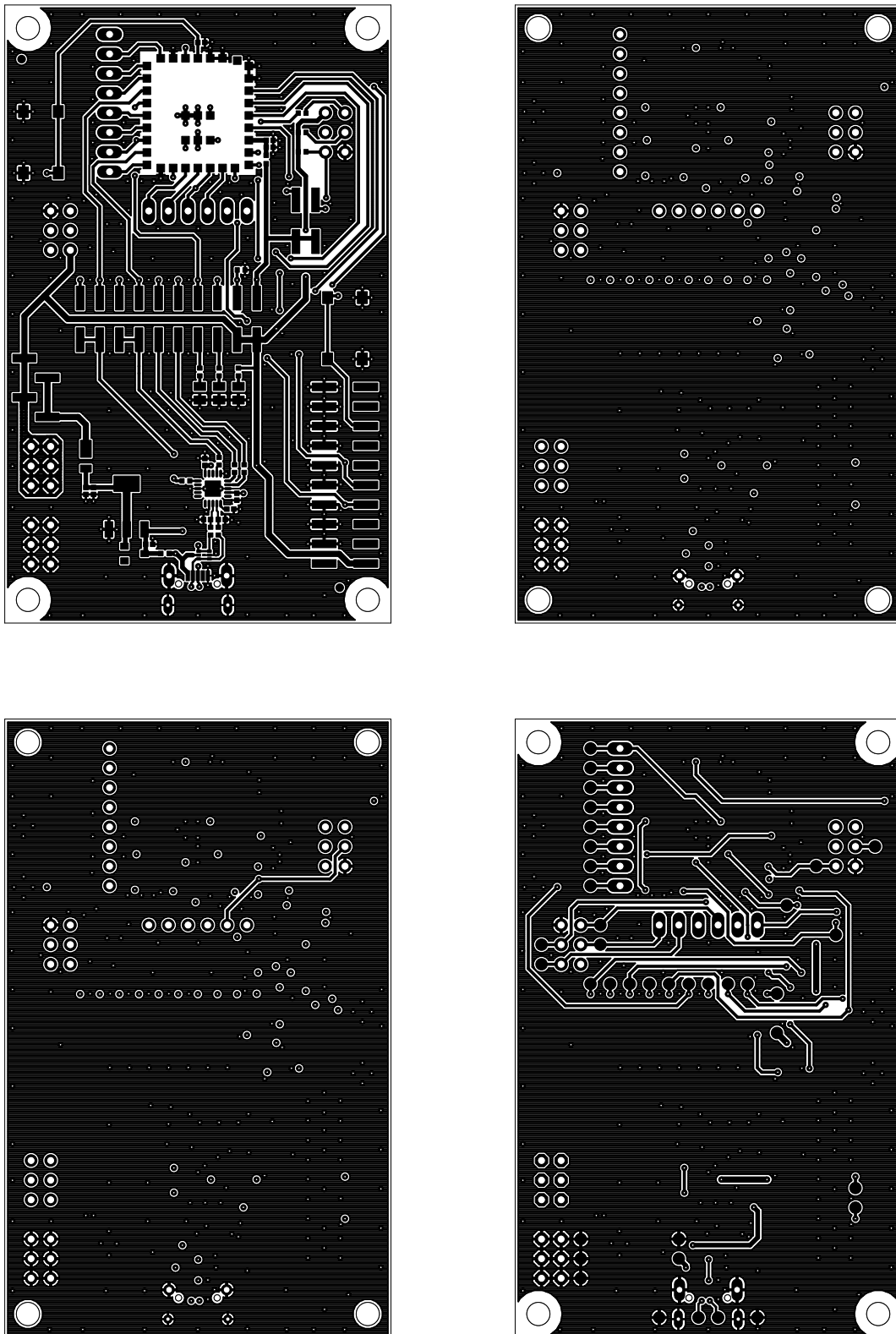

Figure 14: Top layer (upper left), second layer (upper right), third layer (bottom left), fourth layer (bottom right)

7 Manufacturing information

7.1 Moisture sensitivity level

This wireless connectivity product is categorized as JEDEC Moisture Sensitivity Level 3 (MSL3), which requires special handling.

More information regarding the MSL requirements can be found in the IPC/JEDEC J-STD-020 standard on www.jedec.org.

More information about the handling, picking, shipping and the usage of moisture/reflow and/or process sensitive products can be found in the IPC/JEDEC J-STD-033 standard on www.jedec.org.

7.2 Soldering

7.2.1 Reflow soldering

Attention must be paid on the thickness of the solder resist between the host PCB top side and the modules bottom side. Only lead-free assembly is recommended according to JEDEC J-STD020.

Profile feature		Value
Preheat temperature Min	$T_{S \text{ Min}}$	150 °C
Preheat temperature Max	$T_{S \text{ Max}}$	200 °C
Preheat time from $T_{S \text{ Min}}$ to $T_{S \text{ Max}}$	t_S	60 - 120 seconds
Ramp-up rate (T_L to T_P)		3 °C / second max.
Liquidous temperature	T_L	217 °C
Time t_L maintained above T_L	t_L	60 - 150 seconds
Peak package body temperature	T_P	260 °C
Time within 5 °C of actual peak temperature	t_P	20 - 30 seconds
Ramp-down Rate (T_P to T_L)		6 °C / second max.
Time 20 °C to T_P		8 minutes max.

Table 10: Classification reflow soldering profile, Note: refer to IPC/JEDEC J-STD-020E

It is recommended to solder this module on the last reflow cycle of the PCB. For solder paste use a LFM-48W or Indium based SAC 305 alloy (Sn 96.5 / Ag 3.0 / Cu 0.5 / Indium 8.9HF / Type 3 / 89%) type 3 or higher.

The reflow profile must be adjusted based on the thermal mass of the entire populated PCB, heat transfer efficiency of the reflow oven and the specific type of solder paste used. Based on the specific process and PCB layout the optimal soldering profile must be adjusted and verified. Other soldering methods (e.g. vapor phase) have not been verified and have to be validated

by the customer at their own risk. Rework is not recommended.

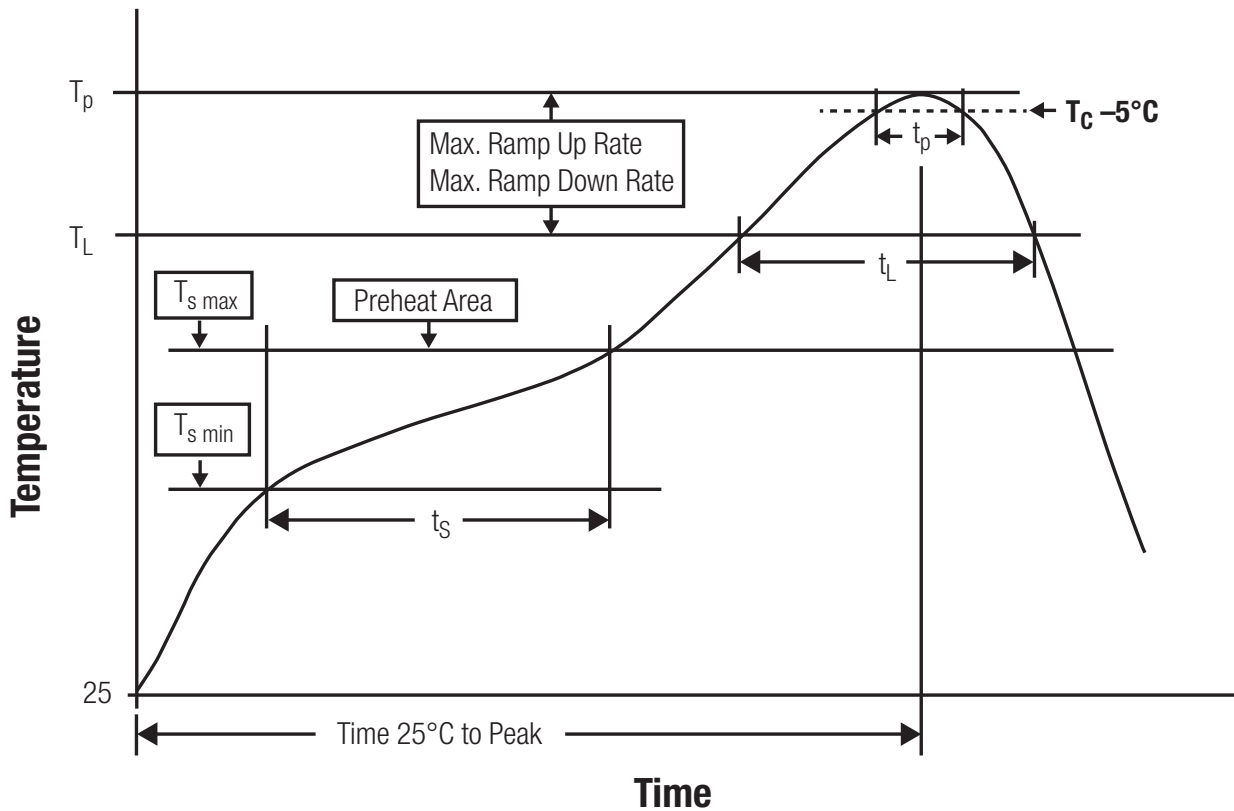

Figure 15: Reflow soldering profile

After reflow soldering, visually inspect the board to confirm proper alignment

7.2.2 Cleaning

Do not clean the product. Any residue cannot be easily removed by washing. Use a "no clean" soldering paste and do not clean the board after soldering.

- Do not clean the product with water. Capillary effects can draw water into the gap between the host PCB and the module, absorbing water underneath it. If water is trapped inside, it may short-circuit adjoining pads. The water may also destroy the label and ink-jet printed text on it.
- Cleaning processes using alcohol or other organic solvents may draw solder flux residues into the housing, which won't be detected in a post-wash inspection. The solvent may also destroy the label and ink-jet printed text on it.
- Do not use ultrasonic cleaning as it will permanently damage the part, particularly the crystal oscillators.

7.2.3 Potting and coating

- If the product is potted in the customer application, the potting material might shrink or expand during and after hardening. Shrinking could lead to an incomplete seal, allowing contaminants into the component. Expansion could damage components. We recommend a manual inspection after potting to avoid these effects.
- Conformal coating or potting results in loss of warranty.
- The RF shield will not protect the part from low-viscosity coatings and potting. An undefined amount of coating and potting will enter inside the shielding.
- Conformal coating and potting will influence the parts of the radio front end and consequently influence the radio performance.
- Potting will influence the temperature behaviour of the device. This might be critical for components with high power.

7.2.4 Other notations

- Do not attempt to improve the grounding by forming metal strips directly to the EMI covers or soldering on ground cables, as it may damage the part and will void the warranty.
- Always solder every pad to the host PCB even if some are unused, to improve the mechanical strength of the module.
- The part is sensitive to ultrasonic waves, as such do not use ultrasonic cleaning, welding or other processing. Any ultrasonic processing will void the warranty.

7.3 ESD handling

This product is highly sensitive to electrostatic discharge (ESD). As such, always use proper ESD precautions when handling. Make sure to handle the part properly throughout all stages of production, including on the host PCB where the module is installed. For ESD ratings, refer to the module series' maximum ESD section. For more information, refer to the relevant chapter 2. Failing to follow the aforementioned recommendations can result in severe damage to the part.

- the first contact point when handling the PCB is always between the local GND and the host PCB GND, unless there is a galvanic coupling between the local GND (for example work table) and the host PCB GND.
- Before assembling an antenna patch, connect the grounds.
- While handling the RF pin, avoid contact with any charged capacitors and be careful when contacting any materials that can develop charges (for example coaxial cable with around 50-80 pF/m, patch antenna with around 10 pF, soldering iron etc.)
- Do not touch any exposed area of the antenna to avoid electrostatic discharge. Do not let the antenna area be touched in a non ESD-safe manner.
- When soldering, use an ESD-safe soldering iron.

7.4 Safety recommendations

It is your duty to ensure that the product is allowed to be used in the destination country and within the required environment. Usage of the product can be dangerous and must be tested and verified by the end user. Be especially careful of:

- Use in areas with risk of explosion (for example oil refineries, gas stations).
- Use in areas such as airports, aircraft, hospitals, etc., where the product may interfere with other electronic components.

It is the customer's responsibility to ensure compliance with all applicable legal, regulatory and safety-related requirements as well as applicable environmental regulations. Disassembling the product is not allowed. Evidence of tampering will void the warranty.

- Compliance with the instructions in the product manual is recommended for correct product set-up.
- The product must be provided with a consolidated voltage source. The wiring must meet all applicable fire and security prevention standards.
- Handle with care. Avoid touching the pins as there could be ESD damage.

Be careful when working with any external components. When in doubt consult the technical documentation and relevant standards. Always use an antenna with the proper characteristics.



Würth Elektronik eiSos radio modules with high output power of up to 500 mW generate a large amount of heat while transmitting. The manufacturer of the end device must take care of potentially necessary actions for his application.

8 Product testing

8.1 Würth Elektronik eiSos in-house production tests

To achieve a high quality standard, Würth Elektronik eiSos follows a philosophy of supplying fully tested radio modules. At the end of the production process, every unit undergoes an optical inspection. Here the quality of soldering, edge castellation and edge milling is monitored.

If this has been passed, the radio modules are handed over to the automatic test equipment for the electrical characterization. This includes:

- Voltage and current tests to ensure proper electrical performance
- RF characteristics (frequency, spectrum, TX power) measurement and calibration
- Radio communication tests
- Firmware and serial number programming
- Host interface communication tests

The automated testing process is logged for internal quality control. The gained measurement data of each unit is analysed to detect defective parts and investigate the corresponding root cause. Defective radio modules are discarded, in order to guarantee a 100% failure-free delivery to customers.

8.2 EMS production tests

The rigorous in-series production testing ensures that EMS don't need to duplicate firmware tests or measurements. This streamlines the process and eliminates the need for additional testing over analogue and digital interfaces during device production. When it comes to device testing, the ideal focus should be on module assembly quality:

- All module pins are soldered properly on the base PCB
- There are no short circuits
- The mounting process did not damage the module
- The communication between host and radio module is working
- The antenna is connected properly

Simple "Go/No go" tests, like checking the RSSI value, give already a hint if the power supply and antenna have been connected properly.

In addition to such standard testing procedures, radio module integrators have the flexibility to perform additional dedicated tests to thoroughly evaluate the device. Specific tests they can consider are:

- Measure module current consumption in a specified operating state. Deviations from expected results (compared to a "Golden Device") can signal potential issues.

- Perform functional tests, including communication checks with the host controller and verification of interfaces.
- Assess fundamental RF characteristics (modulation accuracy, power levels, spectrum). Verify that the device meets expected performance standards.

9 Physical specifications

9.1 Dimensions

Dimensions
15.0 * 16.0 * 3.00 mm

Table 11: Dimensions

Tolerances: see chapter 9.3

9.2 Weight

Weight
1.21 g

Table 12: Weight

Tolerance: ± 0.15 g

9.3 Module drawing

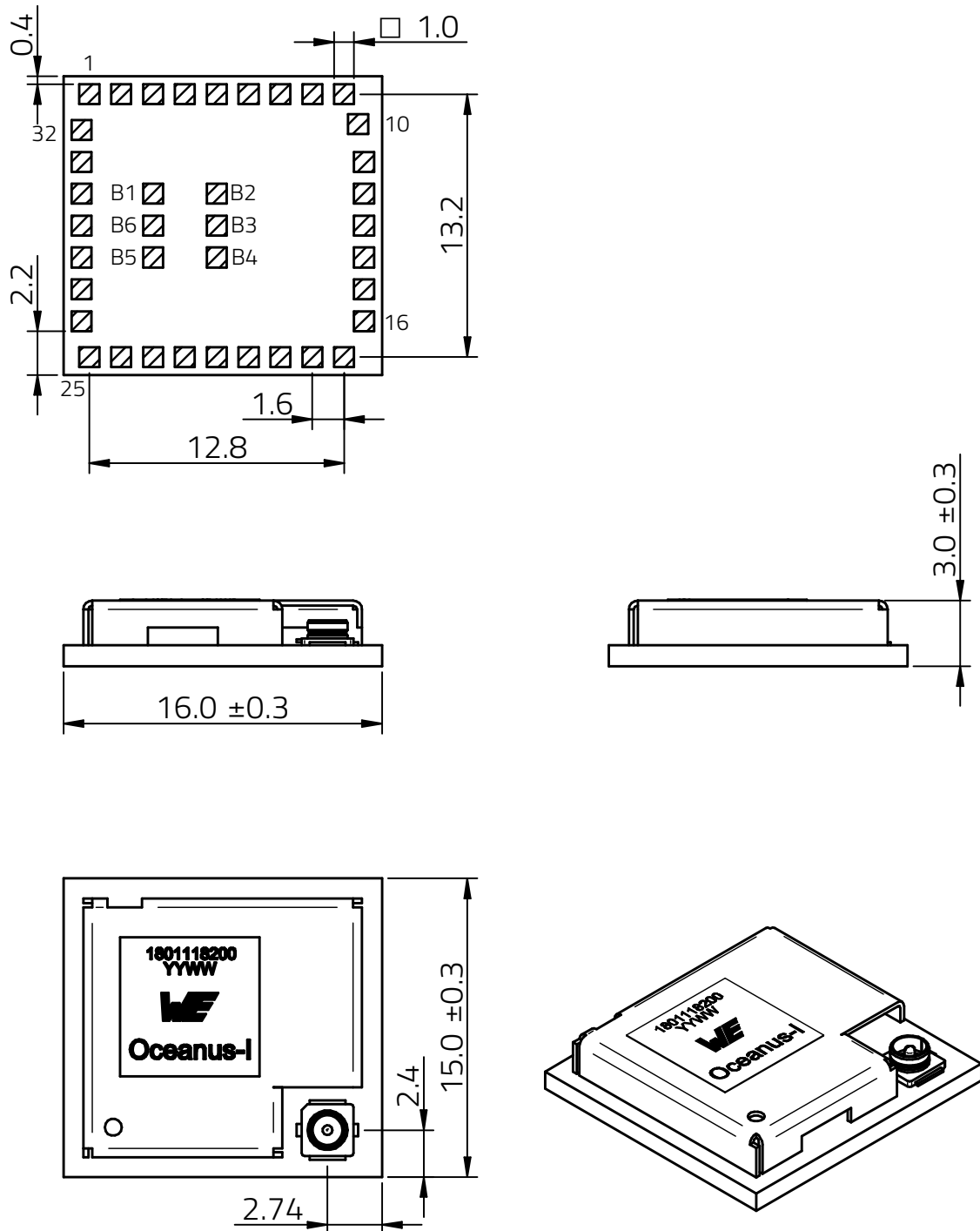

Figure 16: Module dimensions [mm]

9.4 Footprint

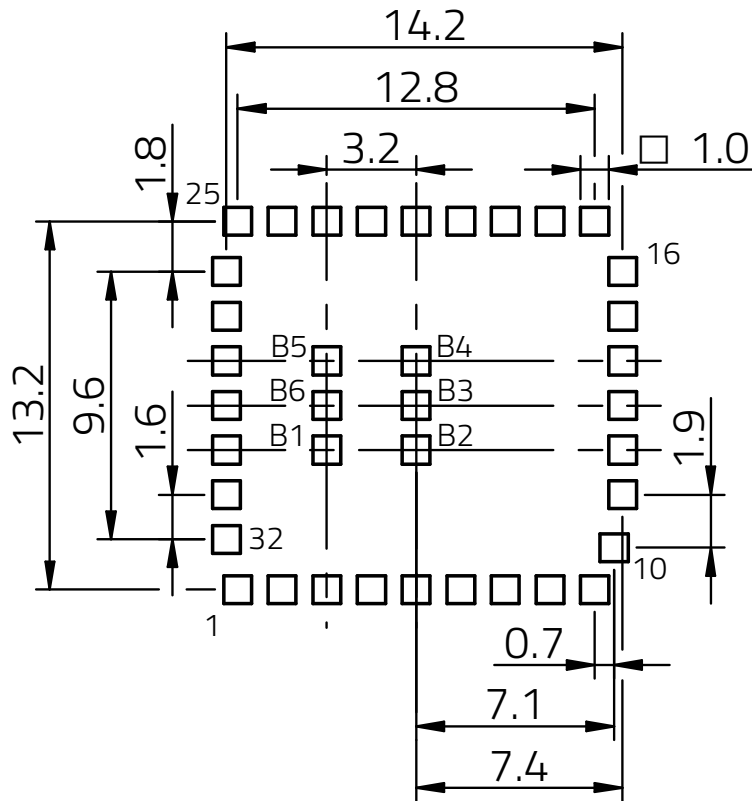

Figure 17: Footprint and dimensions [mm]

10 Marking

10.1 Lot number

The 15 digit lot number is printed in numerical digits as well as in form of a machine readable bar code. It is divided into 5 blocks as shown in the following picture and can be translated according to the following table.

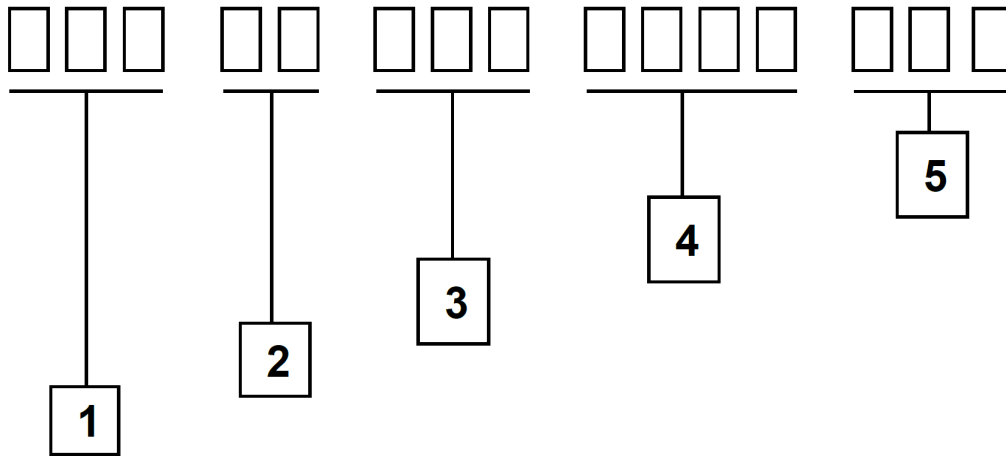

Figure 18: Lot number structure

Block	Information	Example(s)
1	eiSos internal, 3 digits	438
2	eiSos internal, 2 digits	01
3	Radio module hardware version, 3 digits	V2.4 = 024, V12.2 = 122
4	Date code, 4 digits	1703 = week 03 in year 2017, 1816 = week 16 in year 2018
5	Radio module firmware version, 3 digits	V3.2 = 302, V5.13 = 513

Table 13: Lot number details

As the user can perform a firmware update the printed lot number only shows the factory delivery state. The currently installed firmware can be requested from the module using the corresponding product specific command. The firmware version as well as the hardware version are restricted to show only major and minor version not the patch identifier.

10.2 General labeling information

Labels of Würth Elektronik eiSos radio modules include several fields. Besides the manufacturer identification, the product's *WE* order code, serial number and certification information are placed on the label. In case of small labels, additional certification marks are placed on the label of the reel.

The information on the label are fixed. Only the serial number changes with each entity of the radio module. For Oceanus-I the label is as follows:

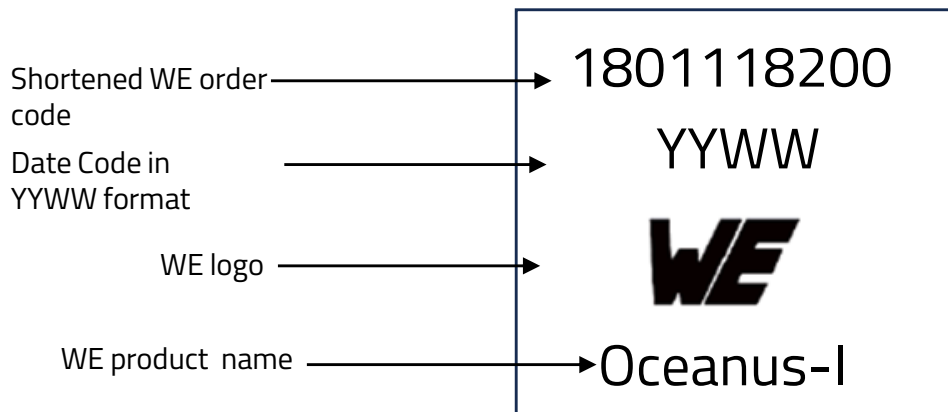

Figure 19: Label of the Oceanus-I

11 Information for explosion protection

In case the end product should be used in explosion protection areas, the following information can be used:

- The module itself is unfused.
- The maximum power of the module is 14 dBm for external antenna.
- The total amount of capacitance of all capacitors is 15.24 μ F.
- The total amount of inductance of all inductors is 15.144 μ H.

12 References

- [1] STMicroelectronics. Web page: STM32WLE5CC. <https://www.st.com/en/microcontrollers-microprocessors/stm32wle5cc.html>.

13 Important notes

The following conditions apply to all goods within the wireless connectivity and sensors product range of Würth Elektronik eiSos GmbH & Co. KG:

General customer responsibility

Some goods within the product range of Würth Elektronik eiSos GmbH & Co. KG contain statements regarding general suitability for certain application areas. These statements about suitability are based on our knowledge and experience of typical requirements concerning the areas, serve as general guidance and cannot be estimated as binding statements about the suitability for a customer application. The responsibility for the applicability and use in a particular customer design is always solely within the authority of the customer. Due to this fact, it is up to the customer to evaluate, where appropriate to investigate and to decide whether the device with the specific product characteristics described in the product specification is valid and suitable for the respective customer application or not. Accordingly, the customer is cautioned to verify that the documentation is current before placing orders.

Customer responsibility related to specific, in particular safety-relevant applications

It has to be clearly pointed out that the possibility of a malfunction of electronic components or failure before the end of the usual lifetime cannot be completely eliminated in the current state of the art, even if the products are operated within the range of the specifications. The same statement is valid for all software source code and firmware parts contained in or used with or for products in the wireless connectivity and sensor product range of Würth Elektronik eiSos GmbH & Co. KG. In certain customer applications requiring a high level of safety and especially in customer applications in which the malfunction or failure of an electronic component could endanger human life or health, it must be ensured by most advanced technological aid of suitable design of the customer application that no injury or damage is caused to third parties in the event of malfunction or failure of an electronic component.

Best care and attention

Any product-specific data sheets, manuals, application notes, PCNs, warnings and cautions must be strictly observed in the most recent versions and matching to the products revisions. These documents can be downloaded from the product specific sections on the wireless connectivity and sensors homepage.

Customer support for product specifications

Some products within the product range may contain substances, which are subject to restrictions in certain jurisdictions in order to serve specific technical requirements. Necessary information is available on request. In this case, the Business Development Engineer (BDM) or the internal sales person in charge should be contacted who will be happy to support in this matter.

Product improvements

Due to constant product improvement, product specifications may change from time to time. As a standard reporting procedure of the Product Change Notification (PCN) according to the JEDEC-Standard, we inform about major changes. In case of further queries regarding the PCN, the Business Development Engineer (BDM), the internal sales person or the technical support team in charge should be contacted. The basic responsibility of the customer as per section 13 and 13 remains unaffected.

All software like "wireless connectivity SDK", "Sensor SDK" or other source codes as well as all PC software tools are not subject to the Product Change Notification information process.

Product life cycle

Due to technical progress and economical evaluation, we also reserve the right to discontinue production and delivery of products. As a standard reporting procedure of the Product Termination Notification (PTN) according to the JEDEC-Standard we will inform at an early stage about inevitable product discontinuance. According to this, we cannot ensure that all products within our product range will always be available. Therefore, it needs to be verified with the Business Development Engineer (BDM) or the internal sales person in charge about the current product availability expectancy before or when the product for application design-in disposal is considered. The approach named above does not apply in the case of individual agreements deviating from the foregoing for customer-specific products.

Property rights

All the rights for contractual products produced by Würth Elektronik eiSos GmbH & Co. KG on the basis of ideas, development contracts as well as models or templates that are subject to copyright, patent or commercial protection supplied to the customer will remain with Würth Elektronik eiSos GmbH & Co. KG. Würth Elektronik eiSos GmbH & Co. KG does not warrant or represent that any license, either expressed or implied, is granted under any patent right, copyright, mask work right, or other intellectual property right relating to any combination, application, or process in which Würth Elektronik eiSos GmbH & Co. KG components or services are used.

General terms and conditions

Unless otherwise agreed in individual contracts, all orders are subject to the current version of the "General Terms and Conditions of Würth Elektronik eiSos Group", last version available at www.we-online.com.

14 Legal notice

Exclusion of liability

Würth Elektronik eiSos GmbH & Co. KG considers the information in this document to be correct at the time of publication. However, Würth Elektronik eiSos GmbH & Co. KG reserves the right to modify the information such as technical specifications or functions of its products or discontinue the production of these products or the support of one of these products without any written announcement or notification to customers. The customer must make sure that the information used corresponds to the latest published information. Würth Elektronik eiSos GmbH & Co. KG does not assume any liability for the use of its products. Würth Elektronik eiSos GmbH & Co. KG does not grant licenses for its patent rights or for any other of its intellectual property rights or third-party rights.

Notwithstanding anything above, Würth Elektronik eiSos GmbH & Co. KG makes no representations and/or warranties of any kind for the

provided information related to their accuracy, correctness, completeness, usage of the products and/or usability for customer applications. Information published by Würth Elektronik eiSos GmbH & Co. KG regarding third-party products or services does not constitute a license to use such products or services or a warranty or endorsement thereof.

Suitability in customer applications

The customer bears the responsibility for compliance of systems or units, in which Würth Elektronik eiSos GmbH & Co. KG products are integrated, with applicable legal regulations. Customer acknowledges and agrees that it is solely responsible for compliance with all legal, regulatory and safety-related requirements concerning its products, and any use of Würth Elektronik eiSos GmbH & Co. KG components in its applications, notwithstanding any applications-related information or support that may be provided by Würth Elektronik eiSos GmbH & Co. KG. Customer represents and agrees that it has all the necessary expertise to create and implement safeguards which anticipate dangerous consequences of failures, monitor failures and their consequences lessen the likelihood of failures that might cause harm and take appropriate remedial actions. The customer will fully indemnify Würth Elektronik eiSos GmbH & Co. KG and its representatives against any damages arising out of the use of any Würth Elektronik eiSos GmbH & Co. KG components in safety-critical applications.

Trademarks

AMBER wireless is a registered trademark of Würth Elektronik eiSos GmbH & Co. KG. All other trademarks, registered trademarks, and product names are the exclusive property of the respective owners.

Usage restriction

Würth Elektronik eiSos GmbH & Co. KG products have been designed and developed for usage in general electronic equipment only. This product is not authorized for use in equipment where a higher safety standard and reliability standard is especially required or where a failure of the product is reasonably expected to cause severe personal injury or death, unless the parties have executed an agreement specifically governing such use. Moreover, Würth Elektronik eiSos GmbH & Co. KG products are neither designed nor intended for use in areas such as military, aerospace, aviation, nuclear control, submarine, transportation (automotive control, train control, ship control), transportation signal, disaster prevention, medical, public information network etc. Würth Elektronik eiSos GmbH & Co. KG must be informed about the intent of such usage before the design-in stage. In addition, sufficient reliability evaluation checks for safety must be performed on every electronic component, which is used in electrical circuits that require high safety and reliability function or performance. By using Würth Elektronik eiSos GmbH & Co. KG products, the customer agrees to these terms and conditions.

15 License terms

These License terms will take effect upon the purchase and usage of the Würth Elektronik eiSos GmbH & Co. KG wireless connectivity products. You hereby agree that these license terms are applicable to the product and the incorporated software, firmware and source codes (collectively, "Software") made available by Würth Elektronik eiSos in any form, including but not limited to binary, executable or source code form. The software included in any Würth Elektronik eiSos wireless connectivity product is purchased to you on the condition that you accept the terms and conditions of these license terms. You agree to comply with all provisions under these license terms.

Limited license

Würth Elektronik eiSos hereby grants you a limited, non-exclusive, non-transferable and royalty-free license to use the software and under the conditions that will be set forth in these license terms. You are free to use the provided software only in connection with one of the products from Würth Elektronik eiSos to the extent described in these license terms. You are entitled to change or alter the source code for the sole purpose of creating an application embedding the Würth Elektronik eiSos wireless connectivity product. The transfer of the source code to third parties is allowed to the sole extent that the source code is used by such third parties in connection with our product or another hardware provided by Würth Elektronik eiSos under strict adherence of these license terms. Würth Elektronik eiSos will not assume any liability for the usage of the incorporated software and the source code. You are not entitled to transfer the source code in any form to third parties without prior written consent of Würth Elektronik eiSos.

You are not allowed to reproduce, translate, reverse engineer, decompile, disassemble or create derivative works of the incorporated software and the source code in whole or in part. No more extensive rights to use and exploit the products are granted to you.

Usage and obligations

The responsibility for the applicability and use of the Würth Elektronik eiSos wireless connectivity product with the incorporated firmware in a particular customer design is always solely within the authority of the customer. Due to this fact, it is up to you to evaluate and investigate, where appropriate, and to decide whether the device with the specific product characteristics described in the product specification is valid and suitable for your respective application or not.

You are responsible for using the Würth Elektronik eiSos wireless connectivity product with the incorporated firmware in compliance with all applicable product liability and product safety laws. You acknowledge to minimize the risk of loss and harm to individuals and bear the risk for failure leading to personal injury or death due to your usage of the product.

Würth Elektronik eiSos' products with the incorporated firmware are not authorized for use in safety-critical applications, or where a failure of the product is reasonably expected to cause severe personal injury or death. Moreover, Würth Elektronik eiSos' products with the incorporated firmware are neither designed nor intended for use in areas such as military, aerospace, aviation, nuclear control, submarine, transportation (automotive control, train control, ship control), transportation signal, disaster prevention, medical, public information network etc. You shall inform Würth Elektronik eiSos about the intent of such usage before design-in stage. In certain customer applications requiring a very high level of safety and in which the malfunction or failure of an electronic component could endanger human life or health, you must ensure to have all necessary expertise in the safety and regulatory ramifications of your applications. You acknowledge and agree that you are solely responsible for all legal, regulatory and safety-related requirements concerning your products and any use of Würth Elektronik eiSos' products with the incorporated firmware in such safety-critical applications, notwithstanding any applications-related information or support that may be provided by Würth Elektronik eiSos. **YOU SHALL INDEMNIFY WÜRTH ELEKTRONIK EISOS AGAINST ANY DAMAGES ARISING OUT OF THE USE OF WÜRTH ELEKTRONIK EISOS' PRODUCTS WITH THE INCORPORATED FIRMWARE IN SUCH SAFETY-CRITICAL APPLICATIONS.**

Ownership

The incorporated firmware created by Würth Elektronik eiSos is and will remain the exclusive property of Würth Elektronik eiSos.

Firmware update(s)

You have the opportunity to request the current and actual firmware for a bought wireless connectivity product within the time of warranty. However, Würth Elektronik eiSos has no obligation to update a modules firmware in their production facilities, but can offer this as a service on request. The upload of firmware updates falls within your responsibility, e.g. via ACC or another software for firmware updates. Firmware updates will not be communicated automatically. It is within your responsibility to check the current version of a firmware in the latest version of the product manual on our website. The revision table in the product manual provides all necessary information about firmware updates. There is no right to be provided with binary files, so called "firmware images", those could be flashed through JTAG, SWD, Spi-Bi-Wire, SPI or similar interfaces.

Disclaimer of warranty

THE FIRMWARE IS PROVIDED "AS IS". YOU ACKNOWLEDGE THAT WÜRTH ELEKTRONIK EISOS MAKES NO REPRESENTATIONS AND WARRANTIES OF ANY KIND RELATED TO, BUT NOT LIMITED TO THE NON-INFRINGEMENT OF THIRD PARTIES' INTELLECTUAL PROPERTY RIGHTS OR THE MERCHANTABILITY OR FITNESS FOR YOUR INTENDED PURPOSE OR USAGE. WÜRTH ELEKTRONIK EISOS DOES NOT WARRANT OR REPRESENT THAT ANY LICENSE, EITHER EXPRESS OR IMPLIED, IS GRANTED UNDER ANY PATENT RIGHT, COPYRIGHT, MASK WORK RIGHT, OR OTHER INTELLECTUAL PROPERTY RIGHT RELATING TO ANY COMBINATION, MACHINE, OR PROCESS IN WHICH THE WÜRTH ELEKTRONIK EISOS' PRODUCT WITH THE INCORPORATED FIRMWARE IS USED. INFORMATION PUBLISHED BY WÜRTH ELEKTRONIK EISOS REGARDING THIRD-PARTY PRODUCTS OR SERVICES DOES NOT CONSTITUTE A LICENSE FROM WÜRTH ELEKTRONIK EISOS TO USE SUCH PRODUCTS OR SERVICES OR A WARRANTY OR ENDORSEMENT THEREOF.

Limitation of liability

Any liability not expressly provided by Würth Elektronik eiSos shall be disclaimed.

You agree to hold us harmless from any third-party claims related to your usage of the Würth Elektronik eiSos' products with the incorporated firmware, software and source code. Würth Elektronik eiSos disclaims any liability for any alteration, development created by you or your customers as well as for any combination with other products.

Applicable law and jurisdiction

Applicable law to these license terms shall be the laws of the Federal Republic of Germany. Any dispute, claim or controversy arising out of or relating to these license terms shall be resolved and finally settled by the court competent for the location of Würth Elektronik eiSos registered office.

Severability clause

If a provision of these license terms is or becomes invalid, unenforceable or null and void, this shall not affect the remaining provisions of the terms. The parties shall replace any such provisions with new valid provisions that most closely approximate the purpose of the terms.

Miscellaneous

Würth Elektronik eiSos reserves the right at any time to change these terms at its own discretion. It is your responsibility to check at Würth Elektronik eiSos homepage for any updates. Your continued usage of the products will be deemed as the acceptance of the change.

We recommend you to be updated about the status of new firmware and software, which is available on our website or in our data sheet and manual, and to implement new software in your device where appropriate.

By ordering a product, you accept these license terms in all terms.

List of Figures

1	Oceanus-I	5
2	Block diagram	6
3	Current consumption during Shutdown mode	8
4	Current consumption during Stop 2 mode	9
5	Pinout (top view)	12
6	Layout	21
7	Placement of the module with integrated antenna	22
8	Dimensioning the antenna connection as micro strip	23
9	Hermippe-III dipole antenna	25
10	Hyperion-I dipole antenna	26
11	Hyperion-II magnetic base antenna with 1.5 m antenna cable	27
12	Reference design: Schematic diagram	29
13	Reference design: Assembly diagram	30
14	Top layer (upper left), second layer (upper right), third layer (bottom left), fourth layer (bottom right)	31
15	Reflow soldering profile	33
16	Module dimensions [mm]	39
17	Footprint and dimensions [mm]	40
18	Lot number structure	41
19	Label of the Oceanus-I	42

List of Tables

1	Ordering information	6
2	Recommended operating conditions	7
3	Absolute maximum ratings	7
4	Current consumption	8
5	Radio characteristics	10
6	Pin characteristics	11
7	Pinout	14
8	Internal pin mapping RF switch to MCU	14
9	RX/TX radio switch	15
10	Classification reflow soldering profile, Note: refer to IPC/JEDEC J-STD-020E	32
11	Dimensions	38
12	Weight	38
13	Lot number details	41



Contact

Würth Elektronik eiSos GmbH & Co. KG
Division Wireless Connectivity & Sensors

Max-Eyth-Straße 1
74638 Waldenburg
Germany

Tel.: +49 651 99355-0
Fax.: +49 651 99355-69
www.we-online.com/wireless-connectivity

WÜRTH ELEKTRONIK MORE THAN YOU EXPECT