



# USER MANUAL

ADRASTEIA-I

2615011136000

VERSION 1.2

NOVEMBER 21, 2023

**WÜRTH ELEKTRONIK** MORE THAN YOU EXPECT

\*\*\*\*\*

## **MUST READ**

### **Check for firmware updates**

Before using the product make sure you use the most recent firmware version, data sheet and user manual. This is especially important for Wireless Connectivity products that were not purchased directly from Würth Elektronik eiSos. A firmware update on these respective products may be required.

We strongly recommend to include in the customer system design, the possibility for a firmware update of the product.

### **Certification Information:**

The certification information is mandatory to check, see chapter 1.3

## Revision history

Manual version	FW version	HW version	Notes	Date
1.0	ADRASTEAI_06.006	1.0	<ul style="list-style-type: none"> <li>Initial release of the manual</li> </ul>	April 2022
1.1	ADRASTEAI_06.006	1.0	<ul style="list-style-type: none"> <li>Added section Adrastea-I GCF Certification.</li> <li>Added section Minimal pin connections.</li> <li>Updated section Application MCU Software Development Kit.</li> </ul>	May 2023
1.2	ADRASTEAI_06.006	1.0	<ul style="list-style-type: none"> <li>Actualized section Regulatory compliance information.</li> </ul>	August 2023

## Abbreviations

Abbreviation	Name
3GPP	3rd Generation Partnership Project
ADC	Analog-to-Digital Converter
ASCI	Advanced Speech Call Items
APN	Access Point Name
BCD	Binary Coded Decimal
DH	Deep Hibernation
EJTAG	Embedded Joint Test Action Group
GLONASS	Global Navigation Satellite System
GNSS	Global Navigation Satellite System
GPS	Global Positioning System
GPIO	General Purpose Input Output
I <sup>2</sup> C	Inter-Integrated Circuit
IoT	Internet of Things
IMEI	International Mobile station Equipment Identity
IMEISV	International Mobile station Equipment Identity and Software Version number
JTAG	Joint Test Action Group
LTE	Long Term Evolution
MCU	Micro controller Unit
MSIO	Master In Slave Out
ME	Mobile Equipment
MT	Mobile Termination
MTU	Maximum Transfer Unit
PA	Power Amplifier
PD	Power Down
PMU	Power Management Unit
PSM	Power Save Mode
RAM	Random Access Memory
RLP	Radio Link Protocol
RTC	Real Time Clock
SINAD	Signal to Noise and Distortion ratio
SIM	Subscriber Identity Module
SPI	Serial Peripheral Interface
SVN	Software Version Number

TA	Terminal Adaptor
TCXO	Temperature Compensated Crystal Oscillator
TE	Terminal Equipment
TTFF	Time To First Fix
UART	Universal Asynchronous Receiver/Transmitter
UE	User Equipment
UICC	Universal Integrated Circuit Card
USIM	Universal Subscriber Identity Module
XO	Crystal Oscillator

# Contents

<b>1</b>	<b>Introduction</b>	<b>8</b>
1.1	Adrastea-I GCF Certification . . . . .	9
1.2	Adrastea-I Deutsche Telekom Certification . . . . .	10
1.3	Benefits of Deutsche Telekom Certified Module . . . . .	11
1.4	Connectivity . . . . .	13
1.5	Module Key Features . . . . .	14
1.6	Block diagram . . . . .	15
1.7	Ordering information . . . . .	15
<b>2</b>	<b>Electrical and Radio Specifications</b>	<b>16</b>
2.1	Recommended Operating Conditions . . . . .	16
2.2	Current Consumption . . . . .	16
	2.2.1 LTE-Cat.M Mode . . . . .	16
	2.2.2 LTE-Cat.NB-IoT Mode . . . . .	17
2.3	LTE Radio Characteristics . . . . .	17
	2.3.1 LTE Supported Bands . . . . .	18
	2.3.2 LTE-Cat.M Mode . . . . .	18
	2.3.3 LTE-Cat.NB-IoT Mode . . . . .	18
	2.3.4 RF Receiving Sensitivity . . . . .	19
	2.3.5 LTE-Cat.M Reference sensitivity . . . . .	19
	2.3.6 LTE-Cat.NB-IoT Reference sensitivity . . . . .	19
	2.3.7 Maximum Output Power . . . . .	20
	2.3.8 LTE-Cat.M Maximum Output Power . . . . .	20
	2.3.9 LTE-Cat.NB-IoT Maximum Output Power . . . . .	20
2.4	GNSS Radio Characteristics . . . . .	20
	2.4.1 GNSS Supported Constellation . . . . .	21
	2.4.2 GNSS: Operating frequencies . . . . .	21
	2.4.3 GNSS: Rx Sensitivity . . . . .	21
	2.4.4 GNSS: Time To First Fix . . . . .	22
	2.4.5 GNSS: Position Accuracy . . . . .	22
<b>3</b>	<b>Pinout</b>	<b>23</b>
3.1	Module Power Up . . . . .	28
3.2	Module Power Down . . . . .	29
3.3	Module Reset . . . . .	29
3.4	WAKEUP pin . . . . .	30
3.5	AT_IN and AT_OUT pins . . . . .	30
3.6	/RESET pin . . . . .	30
3.7	EXT_ALARM pin . . . . .	31
3.8	RF_LTE pin . . . . .	31
3.9	RF_GNSS pin . . . . .	31
3.10	VBACKUP and VCAP pins . . . . .	31
	3.10.1 VCAP pin . . . . .	32
	3.10.2 VBACKUP pin . . . . .	32
	3.10.3 VDDIO . . . . .	32
3.11	E-JTAG Debug port . . . . .	33

3.12	GPIO Pin Information . . . . .	34
3.13	Digital IO Pins Specifications . . . . .	34
<b>4</b>	<b>Module Interfaces</b>	<b>35</b>
4.1	UART Interface . . . . .	35
4.1.1	UART Default Configuration . . . . .	35
4.1.2	UART0 Pin Interface . . . . .	36
4.1.3	UART1 Pin Interface . . . . .	36
4.1.4	UART2 Pin Interface . . . . .	37
4.1.5	UART0 Host Connection . . . . .	37
4.2	SPI Interface . . . . .	39
4.2.1	SPIM Pin Interface . . . . .	39
4.2.2	SPIM Connection . . . . .	39
4.3	I <sup>2</sup> C Interface . . . . .	41
4.3.1	I <sup>2</sup> C Pin Interface . . . . .	41
4.3.2	I <sup>2</sup> C Connection . . . . .	41
4.4	ADC Interface . . . . .	43
4.4.1	ADC Functional Specifications . . . . .	43
4.4.2	ADC Pin Interface . . . . .	44
4.5	SIM Interface . . . . .	44
4.5.1	SIM Pin Interface . . . . .	44
4.6	RF interfaces . . . . .	45
4.7	E-JTAG Debug port . . . . .	45
4.8	GPIO Pin Information . . . . .	46
<b>5</b>	<b>Functional description</b>	<b>47</b>
5.1	Adrastea-I State Transition . . . . .	47
5.2	Adrastea-I Power Saving Modes . . . . .	48
5.2.1	DH0 Mode . . . . .	48
5.2.2	DH1 Mode . . . . .	48
5.2.3	DH2 Mode . . . . .	49
5.3	GNSS Receiver . . . . .	49
5.3.1	Supported GNSS constellations . . . . .	49
5.3.2	GNSS Co-existence with LTE Modem . . . . .	49
5.4	Application MCU . . . . .	50
5.4.1	Application MCU Software Development Kit . . . . .	50
<b>6</b>	<b>Quick start guide</b>	<b>53</b>
6.1	Minimal pin connections . . . . .	53
6.2	Prerequisites . . . . .	54
6.3	Taking into operation . . . . .	56
6.4	Select LTE-M or NB-IoT Mode . . . . .	59
6.5	Register to Network . . . . .	60
6.6	Activate GNSS . . . . .	61
<b>7</b>	<b>Design in guide</b>	<b>64</b>
7.1	Advice for schematic and layout . . . . .	64
7.2	Dimensioning of the micro strip antenna line . . . . .	66

7.3	Antenna solutions . . . . .	66
7.3.1	Wire antenna . . . . .	67
7.3.2	Chip antenna . . . . .	67
7.3.3	PCB antenna . . . . .	67
<b>8</b>	<b>Reference design</b>	<b>68</b>
8.1	Schematic . . . . .	69
8.2	Layout . . . . .	74
<b>9</b>	<b>Manufacturing information</b>	<b>76</b>
9.1	Moisture sensitivity level . . . . .	76
9.2	Soldering . . . . .	76
9.2.1	Reflow soldering . . . . .	76
9.2.2	Cleaning . . . . .	78
9.2.3	Potting and coating . . . . .	78
9.2.4	Other notations . . . . .	78
9.3	ESD handling . . . . .	79
9.4	Safety recommendations . . . . .	79
<b>10</b>	<b>Physical specifications</b>	<b>81</b>
10.1	Dimensions . . . . .	81
10.2	Weight . . . . .	81
10.3	Module drawing . . . . .	82
10.4	Footprint . . . . .	83
<b>11</b>	<b>Marking</b>	<b>84</b>
11.1	Lot number . . . . .	84
11.2	General labeling information . . . . .	85
<b>12</b>	<b>References</b>	<b>86</b>
<b>13</b>	<b>Regulatory compliance information</b>	<b>87</b>
13.1	Important notice EU . . . . .	87
13.2	Conformity assessment of the final product . . . . .	87
13.3	Exemption clause . . . . .	87
13.4	EU Declaration of conformity . . . . .	88
<b>14</b>	<b>Important notes</b>	<b>89</b>
14.1	General customer responsibility . . . . .	89
14.2	Customer responsibility related to specific, in particular safety-relevant applications . . . . .	89
14.3	Best care and attention . . . . .	89
14.4	Customer support for product specifications . . . . .	89
14.5	Product improvements . . . . .	90
14.6	Product life cycle . . . . .	90
14.7	Property rights . . . . .	90
14.8	General terms and conditions . . . . .	90



<b>15 Legal notice</b>	<b>91</b>
15.1 Exclusion of liability . . . . .	91
15.2 Suitability in customer applications . . . . .	91
15.3 Trademarks . . . . .	91
15.4 Usage restriction . . . . .	91
<b>16 License terms</b>	<b>93</b>
16.1 Limited license . . . . .	93
16.2 Usage and obligations . . . . .	93
16.3 Ownership . . . . .	94
16.4 Firmware update(s) . . . . .	94
16.5 Disclaimer of warranty . . . . .	94
16.6 Limitation of liability . . . . .	95
16.7 Applicable law and jurisdiction . . . . .	95
16.8 Severability clause . . . . .	95
16.9 Miscellaneous . . . . .	95

# 1 Introduction

Adrastea-I module is a compact LTE-M/NB-IoT Cellular module with integrated GNSS, integrated ARM Cortex-M4 and 1MB Flash memory for customer developed applications.

Based on the Sony Altair ALT1250 chipset, the Adrastea-I module provides AT-Command based multi-band configurability enabling international multi-regional coverage in LTE Cat M1 / NB1 radio access technologies.

Adrastea-I includes a fully integrated global navigation satellite system solution that supports GPS and GLONASS positioning systems.

The ARM Cortex-M4 processor is exclusively for user application software, and it offers 1 MB of flash and 256 kB of RAM dedicated to this use.

Compact 13.4mm x14.6mm x 1.85mm design allows the module to fit in small-size applications.

The module can be operated through one of two available cellular communication technologies:

- LTE-Cat.M or
- LTE-Cat.NB-IoT.

The Adrastea-I evaluation kit and "Adrastea Commander" tool ([?]) allow getting started with the module and testing its functionalities. The evaluation board can be connected to an USB port of a PC. The evaluation board also represents our reference design. For further information, please refer to the evaluation board manual [?].

The module comes with the declaration of conformity (CE), is compliant to RoHS, REACH. The Adrastea-I module is GCF and Deutsche Telekom certified.

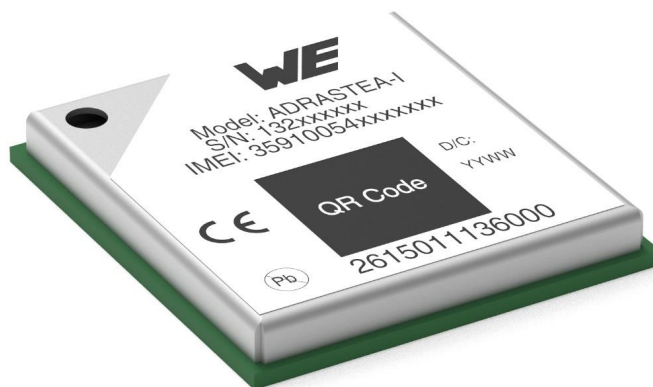

Figure 1: Adrastea-I

## 1.1 Adrastea-I GCF Certification

Adrastea-I is GCF certified module. Major advantage with GCF certified module integrated in end IoT application is that it reduces efforts for industry and operator specific certifications. However, customer shall check certification requirements with network operator before commercial deployment of IoT devices.



Figure 2: Adrastea-I GCF Certification

## 1.2 Adrastea-I Deutsche Telekom Certification

Adrastea-I is certified by Deutsche Telekom.



To Würth Elektronik  
 Forward to Ravindra Singh  
 From Miguel Rodriguez (Deutsche Telekom AG)  
 Contact E-Mail: [miguel.rodriguez@telekom.de](mailto:miguel.rodriguez@telekom.de)  
 Date 07<sup>th</sup> February, 2022  
 Subject Limited Certification for Würth Elektronik ADASTREA-I Communication Module

Dear Würth Elektronik Team,

Deutsche Telekom issues a limited certification for your ADASTREA-I communication module:

Concept Class	LPWA-enabled, multi-mode module (NB1, LTE-M)
Deutsche Telekom (DT) Certification Date	07.02.2022
DT Responsible Entity / Contact	VTI-IOT / Miguel Rodriguez
Certified Deutsche Telekom Affiliates*	<b>(Limited) NB-IoT:</b> AT, CZ, DE, HR, NL, PL, SK <b>(Limited) LTE-M:</b> AT, DE, NL
OEM Firmware Version	ADRASTEAI_06.006
OEM Hardware Version	V1.0

\* Please refer to the OEM Certification Report for Deutsche Telekom Affiliate Country Codes.

Detailed conditions for this limited certification are listed below. Until these topics are addressed, a full technical certification is not granted by Deutsche Telekom. For more details, please refer to the OEM Certification Report of this product.

- OEM is required to present GCF certification for this product.

Deutsche Telekom considers this product to be suitable for IoT projects having large volumes, as there is support for the no-harm to network / communication efficiency feature GSMA TS.34 Radio Policy Manager (RPM).

Kind regards,  
 Deutsche Telekom AG

Miguel Rodriguez  
 Sr. Mgr., IoT Device Verification & Engineering



Adrian Orlikowski  
 Mgr., IoT Device Verification & Engineering

Address Deutsche Telekom AG  
 Landgrabenweg 151, 53227 Bonn  
 Contact + 49 228 181-0, E-Mail: [info@telekom.de](mailto:info@telekom.de)  
 Supervisory Board Timotheus Höttges (Chairman),  
 Board of Directors Adel Al-Saleh, Birgit Bohle, Srinivasan Gopalan, Dr. Christian P. Illek, Thorsten Langheim, Dominique Leroy, Claudia Nemat  
 Commercial register Amtsgericht Bonn HRB 6794  
 Registered office Bonn  
 VAT ID No. DE 123475223  
 WEEE Reg.-No. DE50478376

Figure 3: Adrastea-I Deutsche Telekom Certification

### 1.3 Benefits of Deutsche Telekom Certified Module

Normal Cellular Certification procedure includes 3 different types of certifications:

- Regulatory Certification: CE, FCC and similar based on region.
- Industry Specific Certification: GCF, PTCRB
- Network Operator Certification: Vodafone, Deutsche Telekom, AT&T etc.

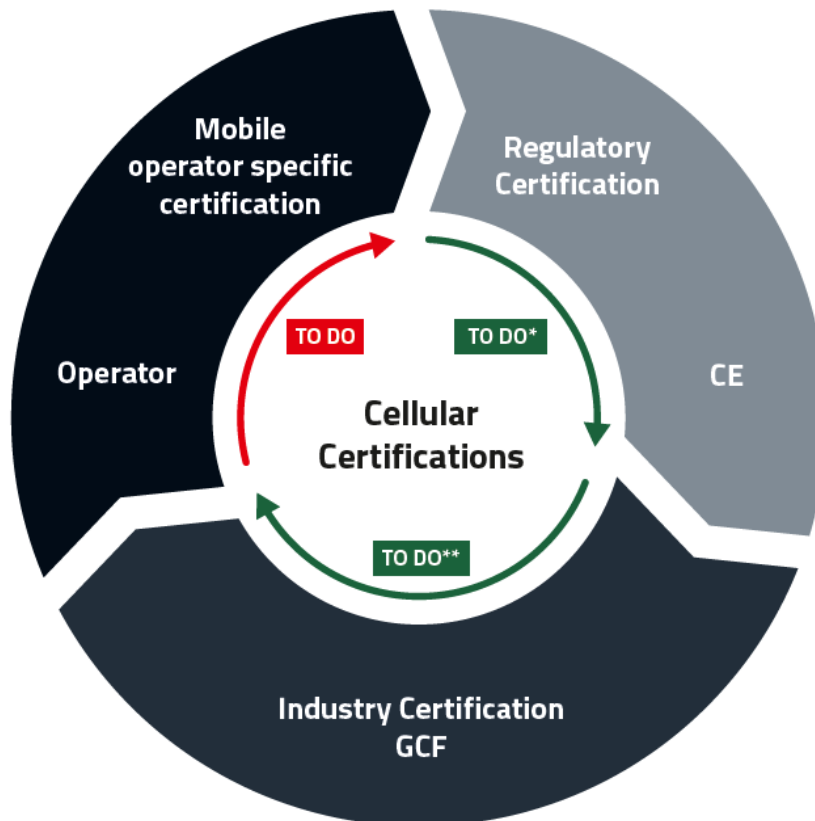

\* To do on device level, Adrastea-I offers CE declaration

\*\* To do on device level, Adrastea-I offers GCF certification

Figure 4: Normal Cellular Certification Process

Pre-Certified Adrastea-I module from Deutsche Telekom brings the following key advantages:

- It enables integration to end device without further end device label Industry specific Certification (i.e. GCF) and Network Operator Certification (Deutsche Telekom).



Regulatory Certifications (i.e. CE, FCC and similar based on region) are still required for the end product.

- Obtain assurance: Pre-certified module reduces the final test effort.
- Save time and money: The end product does not require to go through complex cellular certification process again.



Benefits of certification are applicable only when customer uses connectivity (IoT SIM cards) from Deutsche Telekom. To get the certification benefit, the customer must use connectivity (IoT SIM cards) from Deutsche Telekom

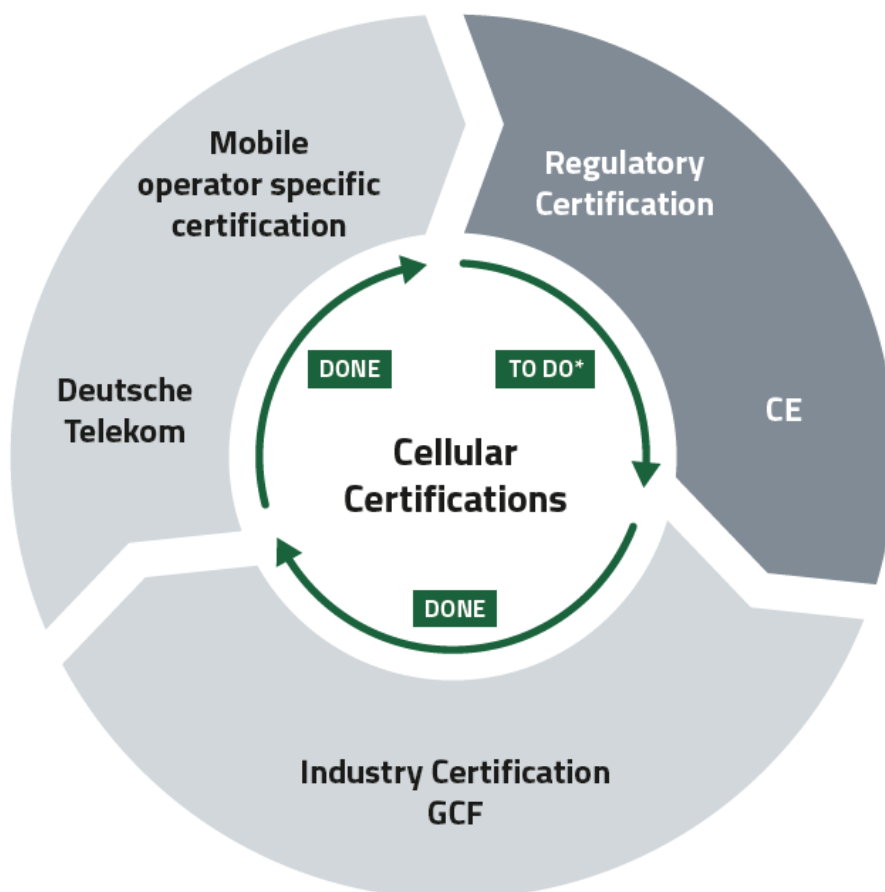

\*To do on device level, Adrastea-I offers CE declaration

Figure 5: Benefits of Deutsche Telekom Certified Module

## 1.4 Connectivity

IoT SIM cards can be ordered from WE-DTAG Connectivity Portal  
<https://iotcreators.com/wuerth/>.

Strong partnership of Würth Elektronik eiSos and Deutsche Telekom offers many advantages for message based connectivity:

- End device label certification Industry specific Certification and Network Operator Certification is not required. Regulatory Certifications (i.e. CE, FCC and similar based on region) is still required for the end product.
- Technology independent charges.
- Roaming charges included. This enables devices to connect on roaming partners networks where Deutsche Telekom does not have network coverage.
- Option for standard and Industrial 2FF/3FF/4FF/MFF2 SIMS.
- Easy online ordering and easy payment.
- Stay flexible and grow at your own speed. As of today one free IoT SIM (i.e. "Starterkit") can be ordered via the portal for testing purposes.
- NB-IoT and LTE-M coverage map is designed to check LTE-M and NB-IoT in different countries.
- Message-brokerage service with NB-IoT / LTE-M connectivity. As of today 120 messages per SIM per day are allowed.

## 1.5 Module Key Features

Feature	Description
Physical Dimensions	13.4mm x 14.6mm x 1.85mm
Supported Networks	- LTE-Cat.M - LTE-Cat.NB-IoT
LTE Supported Bands	<b>LTE-Cat.M:</b> B2/B3/B4/B5/B8/B12/B20/B25/B26/B28 <b>LTE-Cat.NB-IoT:</b> B3/B5/B8/B20/B28
Module Interfaces	- USIM - UART - I <sup>2</sup> C Master - SPI Master - GPIO - ADC - JTAG
Integrated GNSS	Adrastea-I includes a fully integrated global navigation satellite system solution that supports GPS and GLONASS positioning system.
Integrated User MCU	User MCU is exclusively for user application software: - ARM Cortex-M4 - 1 MB Flash Memory - 256 kB RAM
Output Power class	Power Class 3 (23 dBm)
Maximum Data Rate	<b>LTE-Cat.M:</b> Downlink: 300 Kbps, Uplink: 375 Kbps <b>LTE-Cat.NB-IoT:</b> Downlink: 27.2 Kbps, Uplink: 62.5 Kbps
3GPP Standard Compliance	3GPP Release 13 compliant, Upgradable to Rel 14
Firmware Upgrade	- Firmware upgrade over USB interface - Firmware upgrade over air
Supported Protocols	- IPv4, IPv6 - TCP/UDP SOCKET - HTTP/HTTPS - TLS/DTLS - LWM2M Client - MQTT
AT Commands	3GPP TS 27.007 and 3GPP TS 27.005 AT commands, as well as Würth Elektronik eiSos enhanced AT commands
Operating Voltage	- VDD: From 2.3 V to 4.3 V - VDD_FEM: From 3.1 V to 4.3 V
Temperature Range	Operation temperature: -40 °C to +85 °C

Table 1: Module Key Features



## 1.6 Block diagram

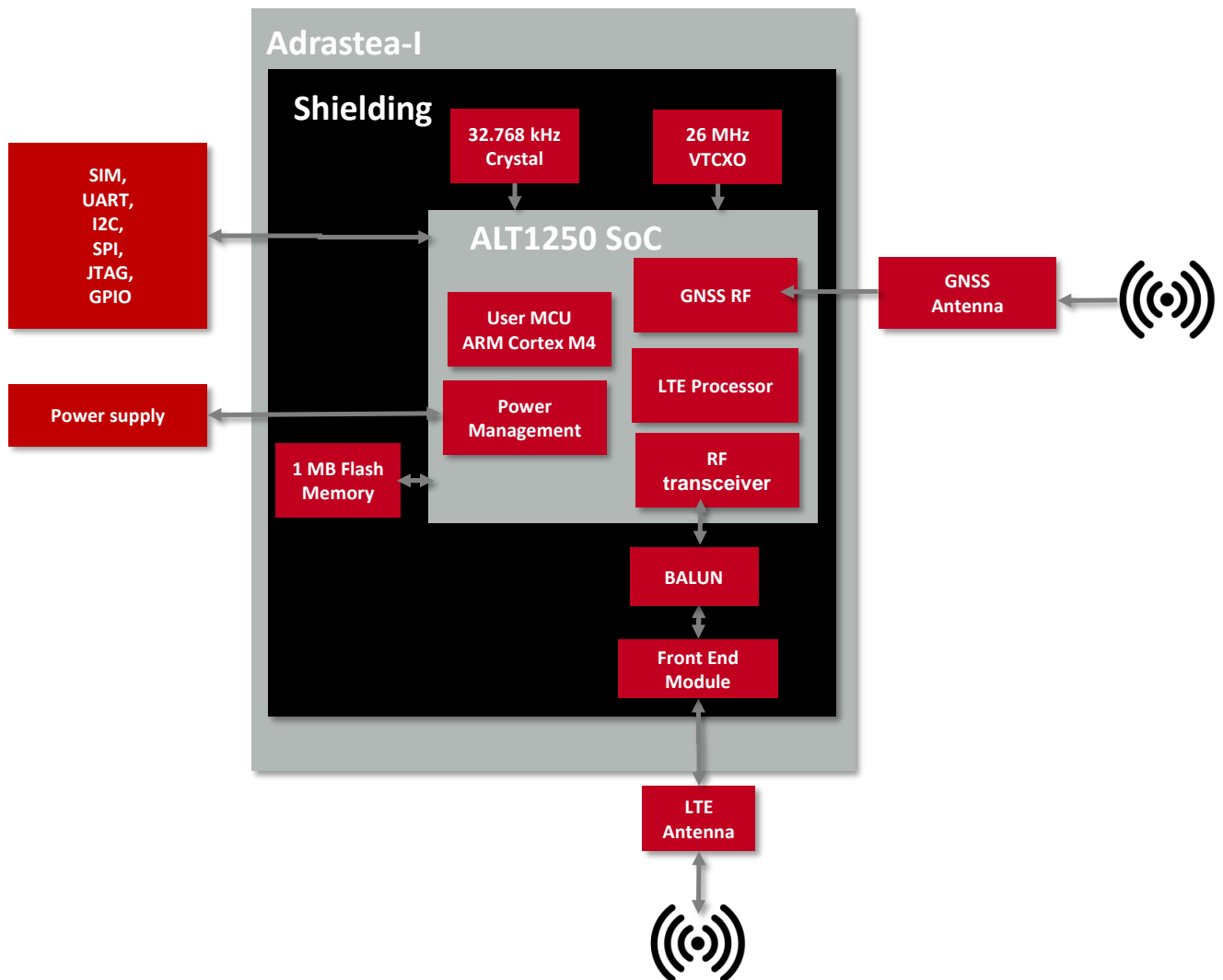

Figure 6: Block diagram

## 1.7 Ordering information

WE order code	Description
2615011136000	Cellular LTE-M/NB-IoT module in T&R packaging
2615029236001	Cellular LTE-M/NB-IoT EV-Kit

Table 2: Ordering information

## 2 Electrical and Radio Specifications

Unless otherwise stated, all the values given in the manual were measured on the Adrastea-I evaluation board under the following conditions: T = 25 °C and powered via 5 V/1A Power Jack. The voltage regulator of the EV board regulates the connected voltage 5 V down to 3.6 V and supplies the remaining parts of the circuit. If the evaluation board is power sourced, the power LED1 lights up.

### 2.1 Recommended Operating Conditions

Parameter	Direction	Min.	Typ.	Max.	Unit
Supply voltage (VDD)	Supply	2.3	3.6	4.3	V
Supply voltage (VDD_FEM)	Supply	3.1	3.6	4.3	V
VSIM	Output	1.7	1.8	1.9	V
VDDIO	Output	1.7	1.8	1.9	V
Operating temperature		-40	25	85	°C

Table 3: Recommended operating conditions

### 2.2 Current Consumption

#### 2.2.1 LTE-Cat.M Mode

Description	Test Condition	Value	Unit
LTE-IDLE	MCU RUN	16.8	mA
	MCU SHUTDOWN	2.9	mA
Peak Current (TX)	TX @23dBm, MCU RUN	454.2	mA
PSM Current (DH0)	MCU SHUTDOWN, LTE RF Disabled (AT+CFUN=0)	1.57	µA
PSM Current (DH1)	MCU SHUTDOWN, LTE RF Disabled (AT+CFUN=0)	39.6	µA
PSM Current (DH2)	MCU SHUTDOWN, LTE RF Disabled (AT+CFUN=0)	82.2	µA
GNSS-Active	MCU RUN, LTE RF Disabled (AT+CFUN=0)	53.98	mA

Table 4: LTE-Cat.M Current consumption

## 2.2.2 LTE-Cat.NB-IoT Mode

Description	Test Condition	Value	Unit
LTE-IDLE	MCU RUN	15.7	mA
	MCU SHUTDOWN	2.8	mA
Peak Current (TX)	TX @23dBm, MCU RUN	434	mA
PSM Current (DH0)	MCU SHUTDOWN, LTE RF Disabled (AT+CFUN=0)	1.57	μA
PSM Current (DH1)	MCU SHUTDOWN, LTE RF Disabled (AT+CFUN=0)	38.5	μA
PSM Current (DH2)	MCU SHUTDOWN, LTE RF Disabled (AT+CFUN=0)	81.5	μA

Table 5: NB-IoT Current consumption

## 2.3 LTE Radio Characteristics

Module performance is based on the quality of the RF link from LTE network to the Adrastea-I module.

The following factors and tasks are critical for the performance of the Adrastea-I module:

- External LTE antenna for signal reception from LTE network.
- RF trace delivering the signal from the external antenna to the LTE RF pad of the Adrastea-I module
- Minimization of external and environmental effects.

### 2.3.1 LTE Supported Bands

#### 2.3.2 LTE-Cat.M Mode

Band	Transmit Band (Tx)	Receive Band (Rx)	Unit
B2	1850 - 1910	1930 - 1990	MHz
B3	1710 - 1785	1805 - 1880	MHz
B4	1710 - 1755	2110 - 2155	MHz
B5	824 - 849	869 - 894	MHz
B8	880 - 915	925 - 960	MHz
B12	699 - 716	729 - 746	MHz
B20	832 - 862	791 - 821	MHz
B25	1850 - 1915	1930 - 1995	MHz
B26	814 - 849	859 - 894	MHz
B28	703 - 748	758 - 803	MHz

Table 6: LTE-Cat.M Supported Bands

#### 2.3.3 LTE-Cat.NB-IoT Mode

Band	Transmit Band (Tx)	Receive Band (Rx)	Unit
B3	1710 - 1785	1805 - 1880	MHz
B5	824 - 849	869 - 894	MHz
B8	880 - 915	925 - 960	MHz
B20	832 - 862	791 - 821	MHz
B28	703 - 748	758 - 803	MHz

Table 7: LTE-Cat.NB-IoT Supported Bands

### 2.3.4 RF Receiving Sensitivity

Unless noted otherwise, the Adrastea-I evaluation board is in static mode, values were measured with Rohde and Schwarz CMW500 equipment.

### 2.3.5 LTE-Cat.M Reference sensitivity

Band	Band Width	Value	Unit
B2	1.4 MHz	-105	dBm
B3	1.4 MHz	-106.4	dBm
B4	1.4 MHz	-106.2	dBm
B5	1.4 MHz	-106.2	dBm
B8	1.4 MHz	-107.2	dBm
B12	1.4 MHz	-105.6	dBm
B20	1.4 MHz	-106.4	dBm
B25	1.4 MHz	-106.8	dBm
B26	1.4 MHz	-106.4	dBm
B28	1.4 MHz	-106	dBm

Table 8: LTE-Cat.M RX Sensitivity

### 2.3.6 LTE-Cat.NB-IoT Reference sensitivity

Band	Value	Unit
B3	-110	dBm
B5	-110	dBm
B8	-110	dBm
B20	-110	dBm
B28	-110	dBm

Table 9: LTE-Cat.NB-IoT RX Sensitivity

### 2.3.7 Maximum Output Power

Unless noted otherwise, the Adrastea-I evaluation board is in static mode, values were measured with Rohde and Schwarz CMW500 equipment.

### 2.3.8 LTE-Cat.M Maximum Output Power

Band	Band Width	Value	Unit
B2	5 MHz	22.9	dBm
B3	5 MHz	21.5	dBm
B4	5 MHz	21.4	dBm
B5	5 MHz	21.7	dBm
B8	5 MHz	22.9	dBm
B12	5 MHz	21.4	dBm
B20	5 MHz	21.7	dBm
B25	5 MHz	23.0	dBm
B26	5 MHz	21.8	dBm
B28	5 MHz	21.9	dBm

Table 10: LTE-Cat.M Maximum Output Power

### 2.3.9 LTE-Cat.NB-IoT Maximum Output Power

Band	Value	Unit
B3	21.8	dBm
B5	22.0	dBm
B8	23.7	dBm
B20	22.1	dBm
B28	22.4	dBm

Table 11: LTE-Cat.NB-IoT Maximum Output Power

## 2.4 GNSS Radio Characteristics

Module performance is based on the quality of the RF link from GNSS satellites to the module.

The following factors and tasks are critical for the performance of the integrated GNSS:

- Free/unimpacted line of sight

- External GNSS antenna for signal reception from GNSS satellites
- RF trace delivering the signal from the external antenna to the RF pad of the GNSS module
- Minimization of external and environmental effects

Adrastea-I supports GPS and GLONASS satellite systems using dedicated hardware accelerators in a power and cost efficient manner. The GNSS receiver shares certain hardware resources with the modem. This enables GNSS measurement slots to be efficiently scheduled based on the modem link state. The device key target is to allow GNSS positioning for asset management applications where infrequent position updates are required.

The Adrastea-I GNSS shares the RF Rx path with the LTE modem and, therefore, cannot operate in parallel with LTE data transfer. Hence this GNSS is not suitable for products that inherently require this co-existence, LTE connection and GNSS tracking.



GNSS cannot co-exist with LTE data transfer. LTE communication has higher priority over GNSS and, therefore, GNSS is automatically shut down once LTE is active (if it was active). While LTE is active, GNSS cannot be activated and all GNSS AT commands are responded with error.

**2.4.1 GNSS Supported Constellation**

Adrastea-I supports the following constellation (Satellite systems):

- GPS
- GLONASS

**2.4.2 GNSS: Operating frequencies**

Description	Min	Typ.	Max	Unit
Input Frequency	1560		1610	MHz

Table 12: Radio characteristics

**2.4.3 GNSS: Rx Sensitivity**

Module sensitivity is the weakest signal level the receiver can work with and it depends on the state of the module.

- Cold start sensitivity is the minimum power required by the module to acquire satellites and perform first fix in cold start.

- Hot start sensitivity is the minimum power required by the module to acquire satellites and perform first fix in hot start.
- Tracking sensitivity is the minimum power required by the module to keep in track of the position fix.

Parameter	Test Condition	Value	Unit
Cold Start	GPS-GLONASS	-145	dBm
Hot Start	GPS-GLONASS	-152	dBm
Tracking	GPS-GLONASS	-160	dBm

Table 13: GNSS RX Sensitivity

#### 2.4.4 GNSS: Time To First Fix

The Time To First Fix (TTFF) is the time needed by the module to achieve the first valid position fix, once the module is powered up or returns from a period of signal blockage.

Depending on the type of start (cold or hot), different TTFF performance is given below.

Parameter	Test Condition	Value	Unit
Cold Start	GPS-GLONASS, Power Level = -120dBm	36	s
Hot Start	GPS-GLONASS, Power Level = -120dBm	1	s

Table 14: GNSS Time to First Fix

#### 2.4.5 GNSS: Position Accuracy

Parameter	Test Condition	Value	Unit
Position Accuracy	GPS-GLONASS, Power Level = -120dBm	1.5	m

Table 15: GNSS Position Accuracy



### 3 Pinout

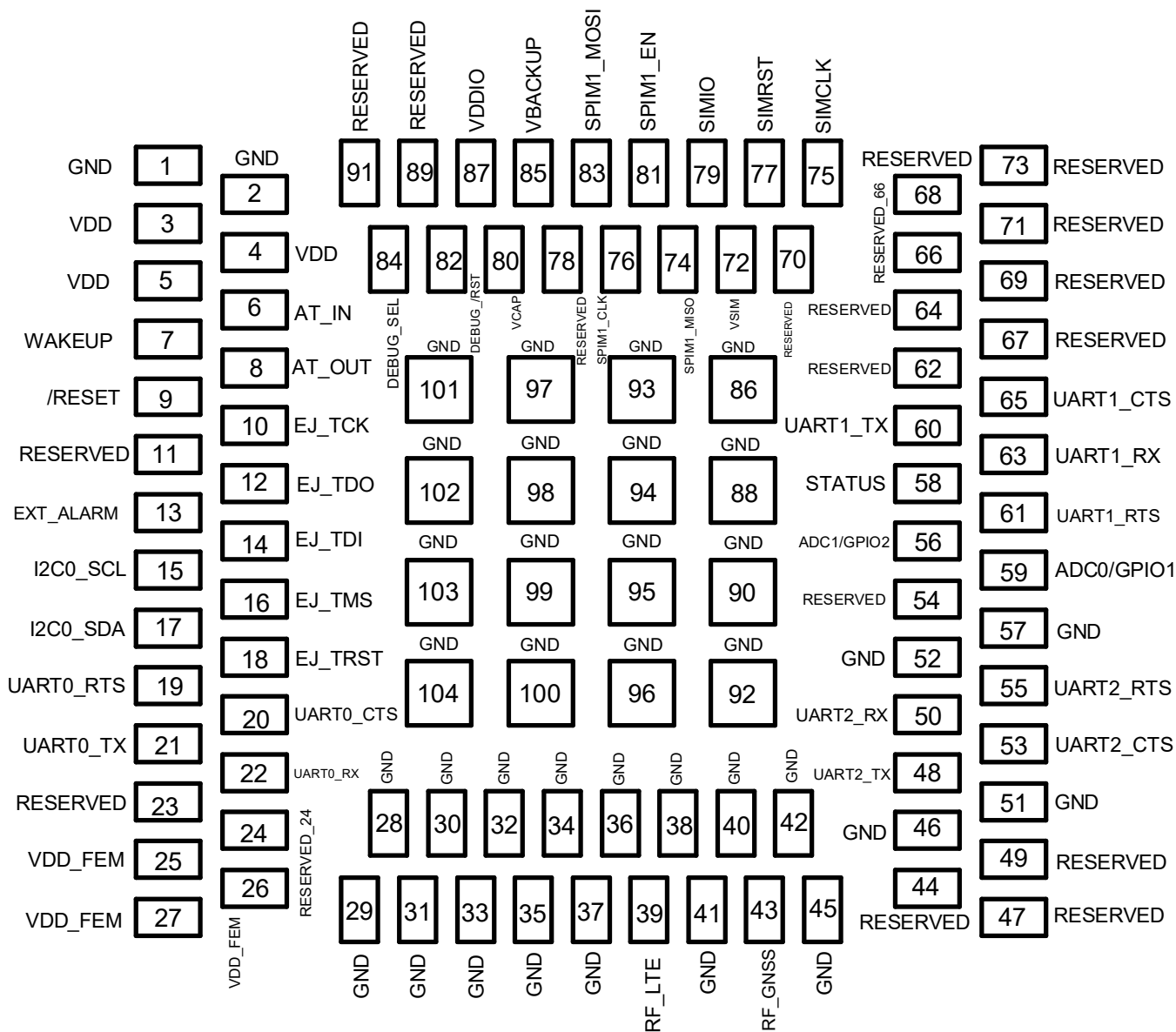

Figure 7: Pinout (top view)

Pin Number	Designation	I/O	Description
1	<i>GND</i>	Supply	Negative Supply Voltage
2	<i>GND</i>	Supply	Negative Supply Voltage
3	<i>VDD</i>	Supply	Power supply for module
4	<i>VDD</i>	Supply	Power supply for module
5	<i>VDD</i>	Supply	Power supply for module
6	<i>AT_IN</i>	Input	Anti-tamper input
7	<i>WAKEUP</i>	Input	Wakeup active high
8	<i>AT_OUT</i>	Output	Anti-tamper output
9	<i>/RESET</i>	Input	Reset active low
10	<i>EJ_TCK</i>	Input	JTAG Test Clock
11	<i>RESERVED</i>	–	Reserved (Shall be soldered but not connected.)
12	<i>EJ_TDO</i>	Output	JTAG Test Data Output
13	<i>EXT_ALARM</i>	Output	Alarm Output
14	<i>EJ_TDI</i>	Input	JTAG Test Data Input
15	<i>I2C0_SCL</i>	Input/Output	I2C serial clock
16	<i>EJ_TMS</i>	Input	JTAG Test Mode Select
17	<i>I2C0_SDA</i>	Input/Output	I2C serial data
18	<i>EJ_TRST</i>	Input	JTAG Test Reset (required external pull down)
19	<i>UART0_RTS</i>	Output	MCU UART0 Request to Send
20	<i>UART0_CTS</i>	Input	MCU UART0 Clear to Send
21	<i>UART0_TX</i>	Output	MCU UART0 Transmit Data
22	<i>UART0_RX</i>	Input	MCU UART0 Receive Data
23	<i>RESERVED</i>	–	Reserved (Shall be soldered but not connected.)
24	<i>RESERVED</i>	–	Reserved (Shall be soldered but not connected.)

Table 16: Pinout

Pin Number	Designation	I/O	Description
25	<i>VDD_FEM</i>	Supply	Power supply for FEM (Front End Module)
26	<i>VDD_FEM</i>	Supply	Power supply for FEM (Front End Module)
27	<i>VDD_FEM</i>	Supply	Power supply for FEM (Front End Module)
28	<i>GND</i>	Supply	Negative supply voltage
29	<i>GND</i>	Supply	Negative supply voltage
30	<i>GND</i>	Supply	Negative supply voltage
31	<i>GND</i>	Supply	Negative supply voltage
32	<i>GND</i>	Supply	Negative supply voltage
33	<i>GND</i>	Supply	Negative supply voltage
34	<i>GND</i>	Supply	Negative supply voltage
35	<i>GND</i>	Supply	Negative supply voltage
36	<i>GND</i>	Supply	Negative supply voltage
37	<i>GND</i>	Supply	Negative supply voltage
38	<i>GND</i>	Supply	Negative supply voltage
39	<i>RF_LTE</i>	RF	RF Signal LTE
40	<i>GND</i>	Supply	Negative supply voltage
41	<i>GND</i>	Supply	Negative supply voltage
42	<i>GND</i>	Supply	Negative supply voltage
43	<i>RF_GNSS</i>	RF	RF Signal GNSS
44	<i>RESERVED</i>	–	Reserved (Shall be soldered but not connected.)
45	<i>GND</i>	Supply	Negative supply voltage
46	<i>GND</i>	Supply	Negative supply voltage
47	<i>RESERVED</i>	–	Reserved (Shall be soldered but not connected.)
48	<i>UART2_TX</i>	Output	UART2 Transmit Data (CLI port)
49	<i>RESERVED</i>	–	Reserved (Shall be soldered but not connected.)
50	<i>UART2_RX</i>	Input	UART2 Receive Data (CLI port)
51	<i>GND</i>	Supply	Negative supply voltage
52	<i>GND</i>	Supply	Negative supply voltage
53	<i>UART2_CTS</i>	Input	UART2 Clear to Send (CLI port)

Table 17: Pinout1

Pin Number	Designation	I/O	Description
54	<i>RESERVED</i>	–	Reserved (Shall be soldered but not connected.)
55	<i>UART2_RTS</i>	Output	UART2 Request to Send (CLI port)
56	<i>ADC1/GPIO2</i>	Input/Output	Auxiliary Analog to Digital Converter Input/Programmable GPIO
57	<i>GND</i>	Supply	Negative supply voltage
58	<i>STATUS</i>	Output	Module Status
59	<i>ADC0/GPIO1</i>	Input/Output	Auxiliary Analog to Digital Converter Input /Programmable GPIO
60	<i>UART1_TX</i>	Output	UART1 Transmit Data (Modem Log port)
61	<i>UART1_RTS</i>	Output	UART1 Request to Send (Modem Log port)
62	<i>RESERVED</i>	–	Reserved
63	<i>UART1_RX</i>	Input	UART1 Receive Data (Modem Log port)
64	<i>RESERVED</i>	–	Reserved (Shall be soldered but not connected.)
65	<i>UART1_CTS</i>	Input	UART1 Clear to Send (Modem Log port)
66	<i>RESERVED</i>	–	Reserved (Shall be soldered but not connected.)
67	<i>RESERVED</i>	–	Reserved (Shall be soldered but not connected.)
68	<i>RESERVED</i>	–	Reserved (Shall be soldered but not connected.)
69	<i>RESERVED</i>	–	Reserved (Shall be soldered but not connected.)
70	<i>RESERVED</i>	–	Reserved (Shall be soldered but not connected.)
71	<i>RESERVED</i>	–	Reserved (Shall be soldered but not connected.)
72	<i>VSIM</i>	Output	SIM Output voltage
73	<i>RESERVED</i>	–	Reserved (Shall be soldered but not connected.)

Table 18: Pinout2

Pin Number	Designation	I/O	Description
74	<i>SPIM1_MISO/GPIO39</i>	Input/Output	MCU_SPIM1_MISO/ Programmable GPIO
75	<i>SIMCLK</i>	Output	SIM Clock
76	<i>SPIM1_CLK/GPIO41</i>	Input/Output	MCU_SPIM1_CLK/ Programmable GPIO
77	<i>SIMRST</i>	Output	SIM Reset
78	<i>RESERVED</i>	–	Reserved (Shall be soldered but not connected.)
79	<i>SIMIO</i>	Input/Output	SIM Data
80	<i>VCAP</i>	Input/Output	Connecting external capacitor as backup for VDD
81	<i>SPIM1_EN/GPIO40</i>	Input/Output	MCU SPI Enable/ Programmable GPIO
82	<i>DEBUG_RST</i>	Input/Output	Reset pin for the JTAG probe
83	<i>SPIM1_MOSI/GPIO38</i>	Input/Output	MCU_SPIM1_MOSI/ Programmable GPIO
84	<i>DEBUG_SEL</i>	Input	Reset pin for the JTAG probe
85	<i>VBACKUP</i>	Input	Input from backup battery
86	<i>GND</i>	Supply	Negative supply voltage
87	<i>VDDIO</i>	Output	Output Voltage (it will turn off at DH0 and DH1 sleep mode)
88	<i>GND</i>	Supply	Negative supply voltage
89	<i>RESERVED</i>	–	Reserved (Shall be soldered but not connected.)
90	<i>GND</i>	Supply	Negative supply voltage
91	<i>RESERVED</i>	–	Reserved(Shall be soldered but not connected.)
92	<i>GND</i>	Supply	Negative supply voltage
93	<i>GND</i>	Supply	Negative supply voltage
94	<i>GND</i>	Supply	Negative supply voltage
95	<i>GND</i>	Supply	Negative supply voltage
96	<i>GND</i>	Supply	Negative supply voltage
97	<i>GND</i>	Supply	Negative supply voltage

Table 19: Pinout3

Pin Number	Designation	I/O	Description
98	<i>GND</i>	Supply	Negative supply voltage
99	<i>GND</i>	Supply	Negative supply voltage
100	<i>GND</i>	Supply	Negative supply voltage
101	<i>GND</i>	Supply	Negative supply voltage
102	<i>GND</i>	Supply	Negative supply voltage
103	<i>GND</i>	Supply	Negative supply voltage
104	<i>GND</i>	Supply	Negative supply voltage

Table 20: Pinout4

### 3.1 Module Power Up

An automatic power up sequence occurs when connecting the device to the power supply (VDD). The automatic power up sequence consists of the following phases:

- Phase 0: RET LDO to ramp up for supplying 1.0V retention core domain.
- Phase 1: IO LDO to ramp up for supplying 1.8 V IO domain.
- Phase 2: RF LDO to ramp up for supplying 1.9V RF domain.
- Phase 3: DCDC to ramp up for supplying 1.3V of Digital LDO and RF.
- Phase 4: DIG LDO to ramp up for supplying 1.0V of digital core domain.
- Phase 5: FLASH LDO to ramp up for supplying 1.8 V of Flash Domain.

Regulators will start ramping only with 1us delay from power good indication of previous phase. The automatic power up sequencing is shown below:

Parameter	Description	Min.	Max.	Unit
t1	When VDD crosses the 0.8V threshold-VRTC should follow the VDD unless it has some capacitance on it.	0	5	µs
t2	Digital retention power up, the VDD slew rate has impact on this timing.	70	100	µs
t3	IO LDO power up.	10	60	µs
t4	RF LDO power up.	10	60	µs
t5	DCDC boot time.	100	200	µs
t6	Core LDO power-up.	10	60	µs
t7	FLASH LDO power-up.	10	60	µs

Table 21: Power Up timing

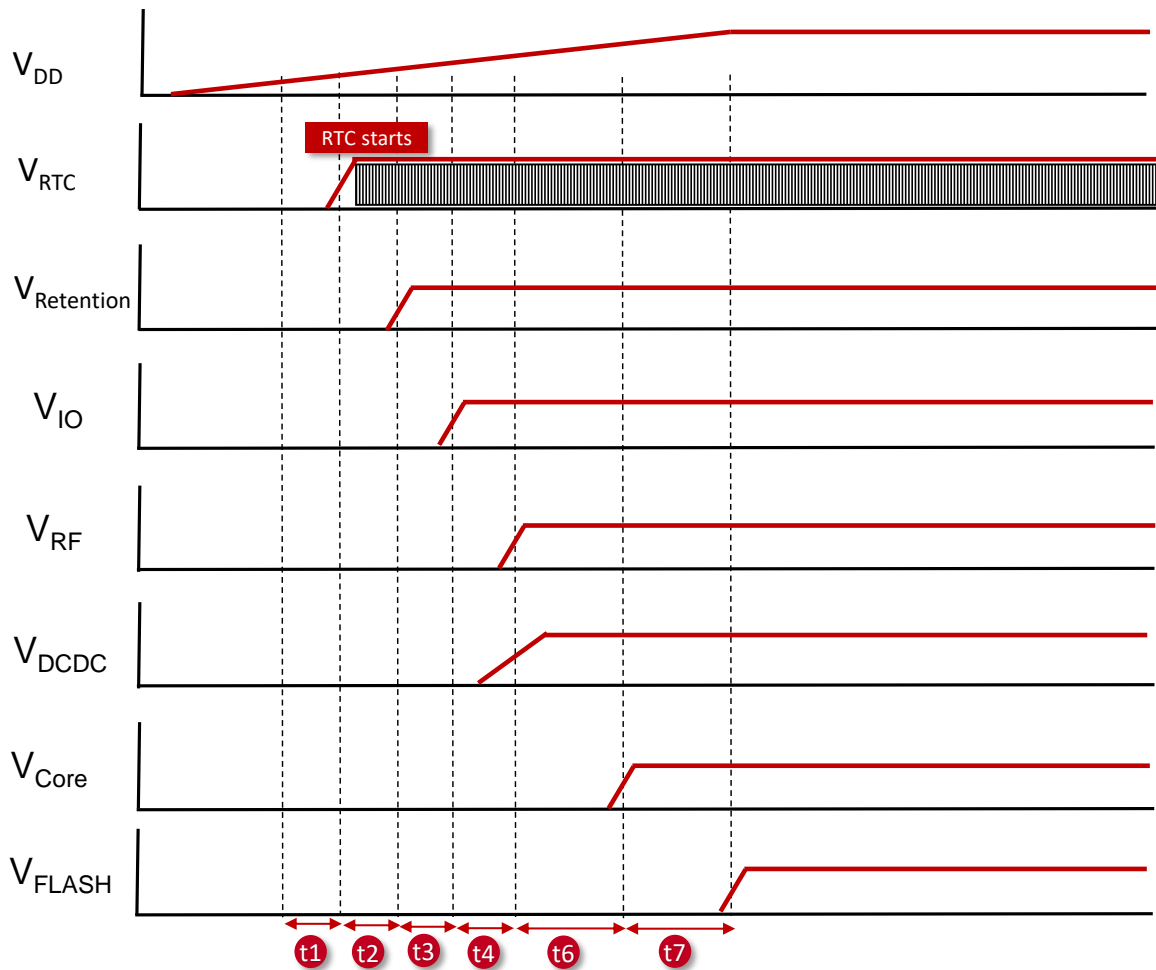

Figure 8: Adrastea-I Power up Sequence

### 3.2 Module Power Down

Power down sequence of the regulators will occur in following conditions:

- Turn off VDD.
- Shutdown is requested by */RESET* pin pulled to low.

### 3.3 Module Reset

Module reset will occur in following conditions:

- Perform power cycle - Turn off/on VDD and power up the device from reset state.
- Using */RESET* pin user can initiate power cycle that resets the device.

### 3.4 WAKEUP pin

This pin can be used to immediately wake up the module when being in low power state. This pin allows the module to get out of sleep mode when pulled HIGH.

The host connected to this pin should always keep the state of this pin (HIGH/LOW) at a known state (not floating) according to the required functionality.

- Pulled HIGH: Wake up internal MCU of module from sleep mode.
- Pulled LOW: Allowing internal MCU of module to go into sleep mode.

### 3.5 AT\_IN and AT\_OUT pins

User can connect the AT\_OUT pin to the AT\_IN pin in order to protect a device or module from tampering. The device will generate a software indication if the AT\_OUT and AT\_IN pins are disconnected.

The anti-tampering mechanism works in all active modes and all DHx power saving modes. If the anti-tampering is not in use, the AT\_IN should be shorted to GND.

### 3.6 /RESET pin

This pin has the highest priority compared to other chip functionalities, therefore asserting it will always force a hard reset. This pin is with internal PU resistor to 1.8V.

- Pulled HIGH: Turn on module regulators and power up the module.
- Pulled LOW: Turn off module regulators and shutdown the module.
- LOW to HIGH: Reset module (keep holding for at least 100ms on LOW level before changing to HIGH).



### 3.7 EXT\_ALARM pin

The EXT\_ALARM pin can be used as an alarm indicator to an external host as per the Adrastea-I power mode. The behavior is as below:

Module State	Test Condition	EXT_ALARM Pin Expected behavior
DH0	MCU Shutdown, AT+CFUN=0	High Impedance
DH1	MCU Shutdown, AT+CFUN=0	High Impedance
DH2	MCU Shutdown, AT+CFUN=0	LOW signal
Active	MCU RUN	HIGH signal

Table 22: EXT\_ALARM Pin

### 3.8 RF\_LTE pin

This is the LTE antenna pin. The impedance should be close to 50 Ω, VSWR (Voltage Standing Wave Ratio) < 1.5.

Connect 50 Ω transmission lines from this pin to the 50 Ω Primary Antenna/Antenna-connector. Please refer to our hardware layout recommendations (chapter 7).

### 3.9 RF\_GNSS pin

This is the GNSS antenna pin. The impedance should be close to 50 Ω, VSWR (Voltage Standing Wave Ratio) < 1.5.

Connect 50 Ω transmission lines from this pin to the 50 Ω Primary Antenna/Antenna-connector. Please refer to our hardware layout recommendations (chapter 7).

### 3.10 VBACKUP and VCAP pins

Adrastea-I supports a battery backup mechanism which allows seamless replacement of a weak battery. The battery should be replaced after the device is placed in DH0 state, and only when the RTC circuitry is operational, and is applied by VRTC.

The VBACKUP pin (battery) or the VCAP (capacitor) can be used as a backup during replacement. The VCAP pin should be left floating if a battery backup is used, while the VBACKUP pin should be left floating if a capacitor backup is used. If the application does not require a battery then both the VBACKUP and the VCAP pins should be left floating.

### 3.10.1 VCAP pin

The capacitor value should be large enough to keep the VCAP supply voltage above 1.8 V for as long as it takes for the battery to be replaced. Equation 1 should be used for calculating the capacitor value ( $C_{CAP}$ ).

Equation1:

$$C_{CAP} = (I_{CAP} \times T) / (V_{to} - V_{MIN})$$

The following parameters should be taken into account when making these calculations:

- The maximum current drawn from VCAP ( $I_{CAP} = 10\mu A$ ).
- The maximum period of time (T) it should take for battery replacement.
- The voltage that the capacitor was charged to ( $V_{to}$ ).
- The minimum voltage that the capacitor can discharge while still providing sufficient operational voltage for the RTC ( $V_{MIN} = 1.8 V$ ).

Example:

If the capacitor is charged to 3.3 V, and battery replacement requires 30 seconds, then the capacitor should be at least 200  $\mu F$  (see equation below).

$$C_{CAP} = (10\mu A \times 30s) / (3.3 V - 1.8 V) = 200\mu F$$

### 3.10.2 VBACKUP pin

There is an option to include an external battery that can maintain the system's supply for a very short time while the main supply (VDD) is absent. The intention is to use a coin battery which is non-rechargeable. VDD thresholds at which the capacitor will start to provide VRTC:

- Similar to VCAP thresholds (see in the above section 3.10.1).
- Pull Low: Turn off module regulators and shutdown the module.
- In case a battery is not used, this pin should be left open (not connected).

### 3.10.3 VDDIO

1.8 V power to the retention's IO.



VDDIO is turned off in DH0 and DH1 state. Therefore it is not allowed to provide external voltage to IOs.

### 3.11 E-JTAG Debug port

The Adrastea-I supports an E-JTAG interface for MCU debugging.

The E-JTAG interface includes the following pins:

Pin Number	Designation	Description
10	<i>EJ_TCK</i>	JTAG Test Clock
12	<i>EJ_TDO</i>	JTAG Test Data Output
14	<i>EJ_TDI</i>	JTAG Test Data Input
16	<i>EJ_TMS</i>	JTAG Test Mode Select
18	<i>EJ_TRST</i>	JTAG Test Reset (Required external Pull down)
84	<i>DEBUG_SEL</i>	HW Pin for EJTAG chain selection

Table 23: E-JTAG Debug port

These pins are not multiplexed with other interfaces in order to save them for debug purposes. The debug port can be directed in direct line to the modem debug chain or MCU. The default direction is set according to the external pin state (*DEBUG\_SEL*). The *DEBUG\_SEL* has an internal Pull Down by default.



Adrastea-I has an internal PD for *EJ\_TRST*, as it is a very sensitive line (in case it will toggle high the processor will enter debug mode), we suggest not keeping it unconnected but to connect it to an external 10K  $\Omega$  PD. Other E-JTAG pins can be kept NC.

### 3.12 GPIO Pin Information

Pin Number	Designation	Description
56	<i>ADC1/GPIO2</i>	Auxiliary Analog to Digital Converter Input /Programmable GPIO
59	<i>ADC0/GPIO1</i>	Auxiliary Analog to Digital Converter Input /Programmable GPIO
74	<i>SPIM1_MISO/GPIO39</i>	MCU_SPIM1_MISO/Programmable GPIO
76	<i>SPIM1_CLK/GPIO41</i>	MCU_SPIM1_CLK/Programmable GPIO
81	<i>SPIM1_EN/GPIO40</i>	MCU SPI Enable/Programmable GPIO
83	<i>SPIM1_MOSI/GPIO38</i>	MCU_SPIM1_MOSI/Programmable GPIO

Table 24: GPIO Pin Information

### 3.13 Digital IO Pins Specifications

These characteristics are applicable for VDDIO in the 1.7V - 1.9V range.

Parameter	Min.	Max.	Unit
Input LOW Level, input and I/O pins	GND	0.3 x VDDIO	V
Input HIGH Level, input and I/O pins	0.7 x VDDIO	VDDIO	V
Output LOW Level		0.2 x VDDIO	V
Output HIGH Level	0.8 x VDDIO		V
Input pull-up resistor resistance	13	45	KΩ
Input pull-up resistor current	11	44	μA
Input pull-down resistor resistance	13.6	45	KΩ
Input pull-down resistor current	11	43	μA

Table 25: Digital IO Pins Specifications



The total current from all IOs combined, and supplied by VDDIO, should not exceed 50mA.

## 4 Module Interfaces

Adrastea-I interfaces and specific pin connections for different interfaces are described in this chapter.

### 4.1 UART Interface

Adrastea-I supports 3 UART interfaces.

UART Number	Description
UART0	MCU UART, this interface is used for AT Commands.
UART1	This interface is used to capture modem logs.
UART2	This interface is used for MCU and Modem Firmware upgrade

Table 26: UART Interfaces

#### 4.1.1 UART Default Configuration

UART	Function	Baud rate	Data	Parity	Stop	Flow Control
UART0	MCU UART	115200	8bit	None	1bit	Hardware RTS/CTS (default None)
UART1	Modem Log Port	921600	8bit	None	1bit	Hardware RTS/CTS (default None)
UART2	Firmware upgrade (CLI Port)	115200	8bit	None	1bit	Hardware RTS/CTS (default None)

Table 27: UART Default Configuration



UART1: Is used to capture the modem logs.  
UART2: Is used for local firmware upgrade.



Flow control is needed for firmware upgrade.



UART communication is not possible when Adrastea-I is in deep hibernate mode (DH0, DH1 and DH2)

### 4.1.2 UART0 Pin Interface

Pin Number	Designation	I/O	Description	Electrical Characteristic
19	<i>UART0_RTS</i>	Output	MCU UART0 Request to Send	1.8 V
20	<i>UART0_CTS</i>	Input	MCU UART0 Clear to Send	1.8 V
21	<i>UART0_TX</i>	Output	MCU UART0 Transmit Data	1.8 V
22	<i>UART0_RX</i>	Input	MCU UART0 Receive Data	1.8 V

Table 28: UART0 Pin Interface



Electrical characteristics (operation voltage) of UART0 pins are 1.8 V.

### 4.1.3 UART1 Pin Interface

Pin Number	Designation	I/O	Description	Electrical Characteristic
61	<i>UART1_RTS</i>	Output	UART1 Request to Send (Modem Log port)	1.8 V
65	<i>UART1_CTS</i>	Input	UART1 Clear to Send (Modem Log port)	1.8 V
60	<i>UART1_TX</i>	Output	UART1 Transmit Data (Modem Log port)	1.8 V
63	<i>UART1_RX</i>	Input	UART1 Receive Data (Modem Log port)	1.8 V

Table 29: UART1 Pin Interface



Electrical characteristics (operation voltage) of UART1 pins are 1.8 V.

**4.1.4 UART2 Pin Interface**

Pin Number	Designation	I/O	Description	Electrical Characteristic
55	<i>UART2_RTS</i>	Output	UART2 Request to Send (CLI port)	1.8 V
53	<i>UART2_CTS</i>	Input	UART2 Clear to Send (CLI port)	1.8 V
48	<i>UART2_TX</i>	Output	UART2 Transmit Data (CLI port)	1.8 V
50	<i>UART2_RX</i>	Input	UART2 Receive Data (CLI port)	1.8 V

Table 30: UART2 Pin Interface



Electrical characteristics (operation voltage) of UART2 pins are 1.8 V.

**4.1.5 UART0 Host Connection**

Connection to host is possible through UART0. This section describes the external host interface which is used to control the modem.



Electrical characteristics (operation voltage) of UART0 pins are 1.8 V.

Below figure shows TX/RX/CTS and RTS connections based on 1.8 V I/O level of external host.

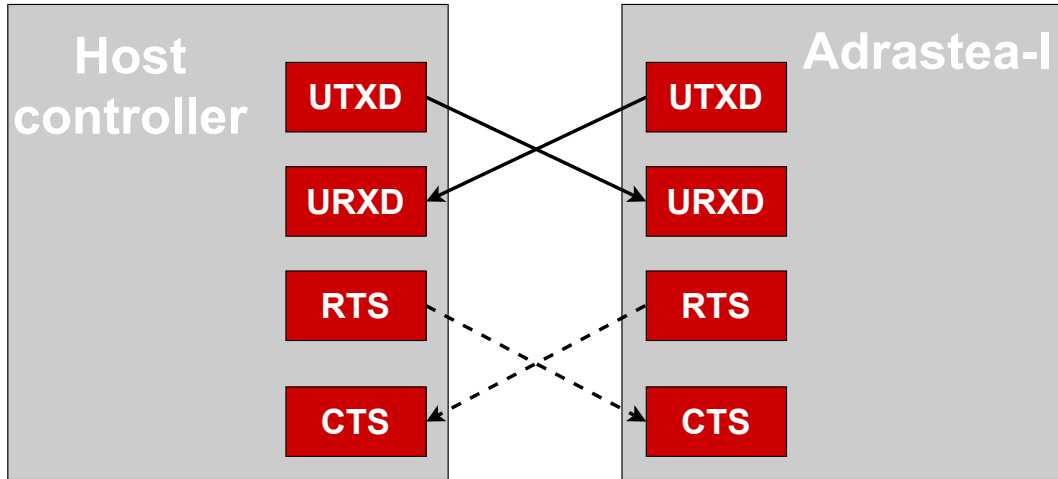

Figure 9: UART0 Host Interface



## 4.2 SPI Interface



The SPI interface is available when using a customized firmware. It is not implemented within the Adrastea-I default MCU firmware.

### 4.2.1 SPIM Pin Interface



Electrical characteristics (operation voltage) of SPIM pins are 1.8 V.

Pin Number	Designation	Description	Typ.	Unit
83	<i>SPIM_MOSI</i>	SPIM_MOSI connect to SPI Slave SDI	1.8	V
74	<i>SPIM_MISO</i>	SPIM_MISO connect to SPI Slave SDO	1.8	V
76	<i>SPIM_CLK</i>	SPIM_CLK connect to SPI Slave CLK	1.8	V
81	<i>SPIM_EN</i>	SPIM_EN connect to SPI Slave CS	1.8	V

Table 31: SPIM Pin Interface

### 4.2.2 SPIM Connection



Electrical characteristics (operation voltage) of SPIM pins are 1.8 V.

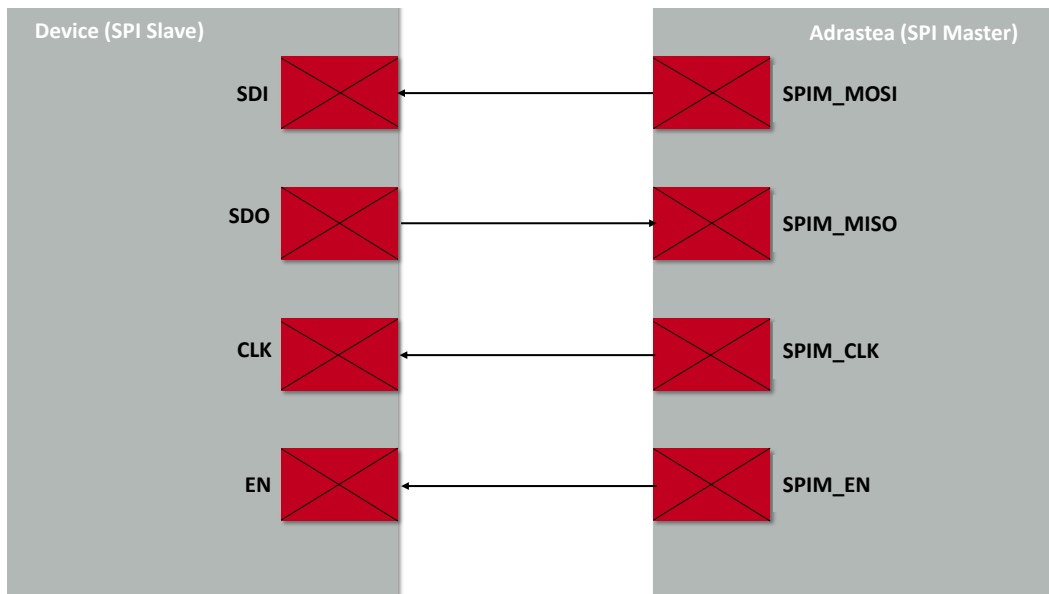

Figure 10: SPIM Connection

### 4.3 I<sup>2</sup>C Interface

Adrastea-I provides an I<sup>2</sup>C interface with clock rate up to 400 kbps. Its operation voltage is 1.8 V.



This interface is enabled but connecting to the external device is subjected to a customized firmware and not supported by the default firmware.

#### 4.3.1 I<sup>2</sup>C Pin Interface



Electrical characteristics (operation voltage) of I<sup>2</sup>C pins are 1.8 V.

Pin Number	Designation	Description	Typ.	Unit
15	<i>I2C_SCL</i>	I <sup>2</sup> C SCL connect to external device SCL	1.8	V
17	<i>I2C_SDA</i>	I <sup>2</sup> C SDA connect to external device SDA	1.8	V

Table 32: I<sup>2</sup>C Pin Interface

#### 4.3.2 I<sup>2</sup>C Connection



Electrical characteristics (operation voltage) of I<sup>2</sup>C pins are 1.8 V.

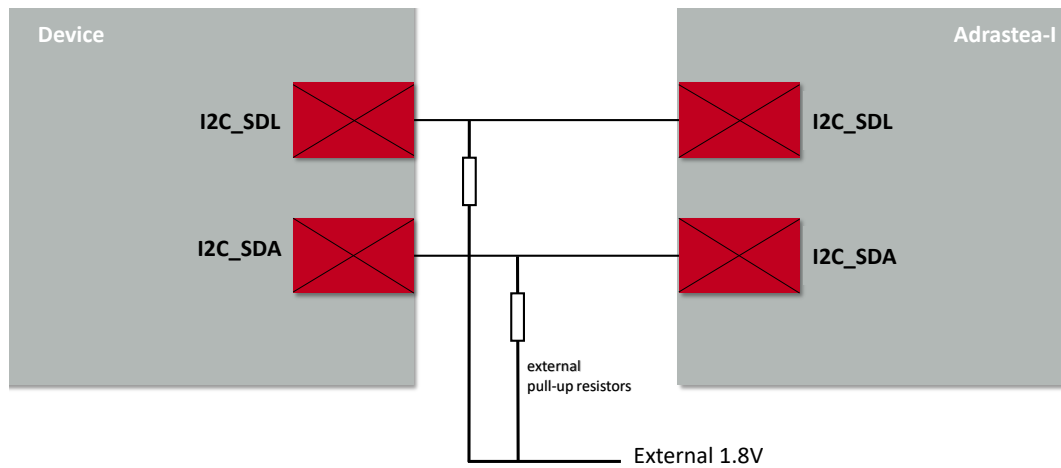

Figure 11: I<sup>2</sup>C Connection

## 4.4 ADC Interface

Adrastea-I includes two auxiliary A/D converters to sense external analog inputs.



Electrical characteristics (operation voltage) of ADC pins are 1.8 V.

ADC Interface	Description	Min	Max.	Unit
ADC0	Auxiliary Analog to digital converter channel 0	0	1.8	V
ADC1	Auxiliary Analog to digital converter channel 1	0	1.8	V

Table 33: ADC Interfaces

### 4.4.1 ADC Functional Specifications

Symbol	Parameter	Min	Typ.	Max	Unit
N	Resolution	6		12	Bits
F <sub>CLK</sub>	Clock rate	4	40	52	MHz
F <sub>S</sub>	Conversion rate per channel (Note1)		F <sub>c</sub> / (N+3)		MSPS
V <sub>IN</sub>	Input voltage range		1.8		V
INL	Integral Nonlinearity		±1	±2	LSB
DNL	Differential Nonlinearity	-0.9		0.9	LSB
R <sub>IN</sub>	Input resistance (Note3)			1.42	MΩ
C <sub>IN</sub>	Input capacitance during sampling	2.6			pF

Table 34: ADC Functional Specifications

Note1: The general formula for this conversion rate is:  $F_S = F_{CLK} / (N+3) / \text{Number of sources}$ .

Note2: Conversion rate at 3.46 MSPS and 12bit resolution.

Note3: Measured Input resistance and current on ADC0 with different voltage labels are as below:

Input Voltage (V)	Input Resistance (MΩ)	Measured Current (μA)
1.0	0.98	1.02
1.5	1.42	1.07
1.7	1.38	1.23

Table 35: Measured Input Resistance

#### 4.4.2 ADC Pin Interface

Pin Number	Designation	Description
56	<i>ADC1/GPIO2</i>	Auxiliary Analog to Digital Converter Input /Programmable GPIO
59	<i>ADC0/GPIO1</i>	Auxiliary Analog to Digital Converter Input /Programmable GPIO

Table 36: ADC Pin Interface

### 4.5 SIM Interface

Adrastea-I supports 1.8 V SIM Cards.

#### 4.5.1 SIM Pin Interface



Electrical characteristics (operation voltage) of SIM pins are 1.8 V.

Pin Number	Designation	Description
72	<i>VSIM</i>	SIM Output voltage
75	<i>SIMCLK</i>	SIM Clock
77	<i>SIMRST</i>	SIM Reset
79	<i>SIMIO</i>	SIM Data

Table 37: SIM Pin Interface

## 4.6 RF interfaces

Pin Number	Designation	Description
39	<i>RF_LTE</i>	RF Signal LTE (The impedance (S11) should be close to 50 Ω, VSWR < 1.5 Please refer to our hardware layout recommendations (chapter 7).
43	<i>RF_GNSS</i>	RF Signal GNSS (The impedance (S11) should be close to 50 Ω, VSWR < 1.5 Please refer to our hardware layout recommendations (chapter 7).

Table 38: RF Pin Interface

## 4.7 E-JTAG Debug port

The Adrastea-I supports an E-JTAG interface for MCU debugging.

The E-JTAG interface includes the following pins:

Pin Number	Designation	Description
10	<i>EJ_TCK</i>	JTAG Test Clock
12	<i>EJ_TDO</i>	JTAG Test Data Output
14	<i>EJ_TDI</i>	JTAG Test Data Input
16	<i>EJ_TMS</i>	JTAG Test Mode Select
18	<i>EJ_TRST</i>	JTAG Test Reset (Required external Pull down)
84	<i>DEBUG_SEL</i>	HW Pin for EJTAG chain selection

Table 39: E-JTAG Debug port

These pins are not multiplexed with other interfaces in order to save them for debug purposes. The debug port can be directed in direct line to the modem debug chain or MCU. The default direction is set according to the external pin state (*DEBUG\_SEL*). The *DEBUG\_SEL* has an internal Pull Down by default.



Adrastea-I has an internal PD for *EJ\_TRST*, as it is a very sensitive line (in case it will toggle high the processor will enter debug mode), we suggest not keeping it unconnected but to connect it to an external 10K ohm PD. Other E-JTAG pins can be kept NC.

## 4.8 GPIO Pin Information

Pin Number	Designation	Description
56	<i>ADC1/GPIO2</i>	Auxiliary Analog to Digital Converter Input /Programmable GPIO
59	<i>ADC0/GPIO1</i>	Auxiliary Analog to Digital Converter Input /Programmable GPIO
74	<i>SPIM1_MISO/GPIO39</i>	MCU_SPIM1_MISO/Programmable GPIO
76	<i>SPIM1_CLK/GPIO41</i>	MCU_SPIM1_CLK/Programmable GPIO
81	<i>SPIM1_EN/GPIO40</i>	MCU SPI Enable/Programmable GPIO
83	<i>SPIM1_MOSI/GPIO38</i>	MCU_SPIM1_MOSI/Programmable GPIO

Table 40: GPIO Pin Information



## 5 Functional description

The Adrastea-I LTE-M/NB-IoT module is intended to be used as a radio sub-system in order to provide LTE-M/NB-IoT communication capabilities to the system.

The Adrastea-I modem firmware is 3GPP Release 13 compliant, which is upgradable to Release-14.

The UART-0 acts as the primary interface between the module and a host micro-controller. The module can be controlled and operated using a set of AT-commands over UART-0.

Adrastea-I is a high-performance, multi-band dual mode LTE-M/NB-IoT module with ultra-low power consumption.

Embedded GNSS allows location applications to track positioning.

An integrated application MCU is available for customer applications.

### 5.1 Adrastea-I State Transition

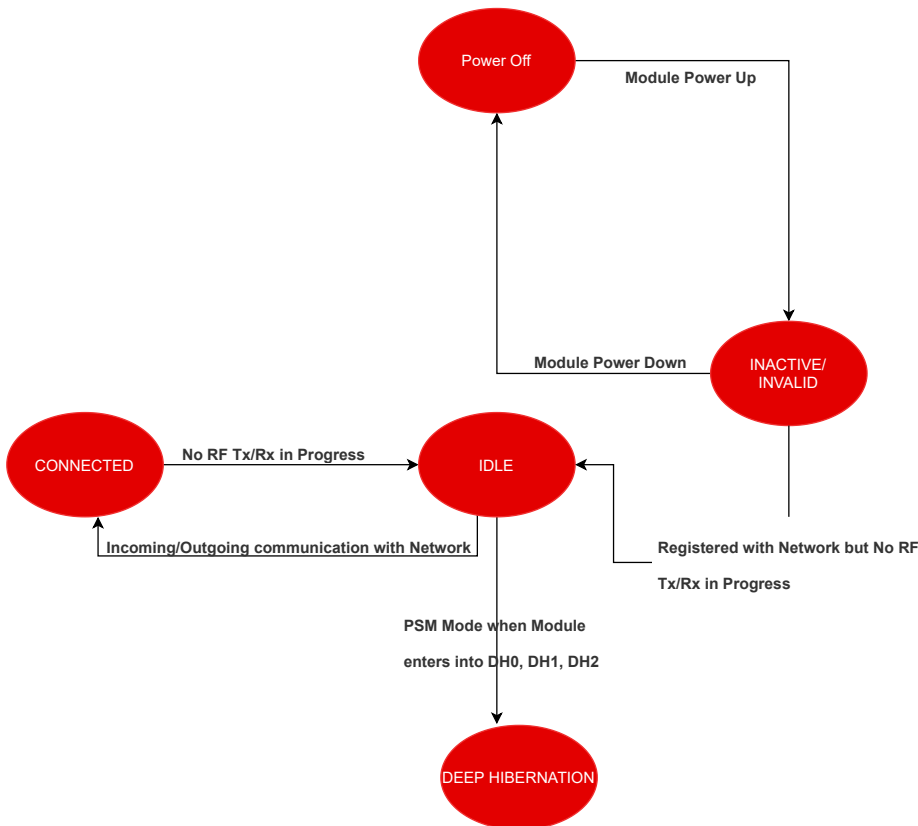

Figure 12: Adrastea-I State Transition

## 5.2 Adrastea-I Power Saving Modes

This section summarizes the various low power operating modes of the Adrastea-I module.



The Adrastea-I selects the described power modes according to the the maximum allowed chip power mode configuration. The currently configured power mode can be checked with AT command:  
`at%getacfg="pm.conf.max_allowed_pm_mode"`

### 5.2.1 DH0 Mode

DH0 mode provides long entry and recovery times and is mainly used for very long inactivity intervals like power saving mode. In this mode all digital logic is powered down, memories are not retained, IO are not stored.

This is the lowest power mode of the system.

One of the following dedicated actions is used to wake up from this mode:

- WAKEUP (Wakeup active high).
- Module reset (/RESET - Reset active low).
- Module power down.



In this mode VDDIO is turned off, therefore it is not allowed to provide external voltage to IOs that are not defined as a wake up source in the list above

### 5.2.2 DH1 Mode

All digital logic is powered down, a configurable amount of retention memory is retained (64KB granularity), IOs are not stored.

One of the following dedicated actions is used to wake up from this mode:

- WAKEUP (Wakeup active high).
- Module reset (/RESET - Reset active low).
- Module power down.

A Wakeup event initiates a boot flow. This mode is similar to DH2; however, lower power consumption due to IO logic unretained.



In this mode VDDIO is turned off, therefore it is not allowed to provide external voltage to IOs that are not defined as a wake up source in the list above

### 5.2.3 DH2 Mode

Achieve the lowest power consumption while retaining the content of SRAM and registers. All digital logic is powered down.

One of the following dedicated pins is used to wake up from this mode:

- WAKEUP (Wakeup active high).
- Module reset (/RESET - Reset active low).
- Module power down.

Wakeup event initiates a boot flow. This mode is similar to DH1; however, it also enables output IOs to latch and wakeup from digital inputs.



Adrastea-I is set by default in DH2 state.

## 5.3 GNSS Receiver

Adrastea-I supports GPS and GLONASS satellite systems using dedicated hardware accelerators in a power and cost efficient manner. The GNSS receiver shares certain hardware resources with the modem. This enables GNSS measurement slots to be efficiently scheduled based on the modem link state. The device key target is to allow GNSS positioning for asset management applications where infrequent position updates are required. External LTE and GNSS antennas are required.

### 5.3.1 Supported GNSS constellations

Adrastea-I supports the following constellation combinations:

- GPS
- GLONASS

### 5.3.2 GNSS Co-existence with LTE Modem

The Adrastea-I GNSS shares the RF Rx path with the LTE modem and, therefore, cannot operate in parallel with LTE data transfer. Hence this GNSS is not suitable for products that inherently require this co-existence, LTE connection and GNSS tracking.



GNSS cannot co-exist with LTE data transfer. LTE communication has higher priority over GNSS and, therefore, GNSS is automatically shut down once LTE is active (if it was active). While LTE is active, GNSS cannot be activated and all GNSS AT commands are responded with error.

## 5.4 Application MCU

This section provides information on the User MCU subsystem. This MCU is exclusively for customer applications.

- ARM Cortex-M4 MCU
- Flash size: 1 MB
- RAM Size: 256 KB

### 5.4.1 Application MCU Software Development Kit

The MCU SDK allows software developers to write their own applications directly onto the ALT1250 internal application MCU with no need to write code into the ALT1250 Modem Application Processor (MAP).



MCU has default PowerManager firmware. PowerManager example demonstrates how MCU sleep (power save) works.



The "map" command is required before sending AT commands to modem.

The SDK can be downloaded from <https://developer.sony.com/>. To get access to the portal, Follow below procedure:

- Fill the Sony MCU access request form:  
<https://bit.ly/44lqgKD>



Important to fill in Module vendor "Wurth Elektronik" at 6 in a link above.

- Sony receives and process the request , Sony will provide 7 digit registration number to email id provided in above form.



Please note completion time for this request is 3-5 working days.

- With 7 digit registration number, access below link and getting right into the Sony MCU portal.

<https://developer.sony.com/develop/cellular-iot/register>.

Email

Password

Retype password

First name

Last name

Company name

Enter the registration number:

I have read and agree to the [Terms of Use and Privacy Policy of Sony's Developer World](#)

I have read and agree to the [Terms of Use of Sony Semiconductor Israel](#)

Register

Figure 13: Adrastea-I: Sony MCU portal registration



Some information provided in this document can change. Please refer to the link for latest information

<https://developer.sony.com/develop/cellular-iot/how-to-register>

- Login into sony portal <https://developer.sony.com/> using credentials created in above steps.
- Click on "Develop->IoT->Altair development portal".

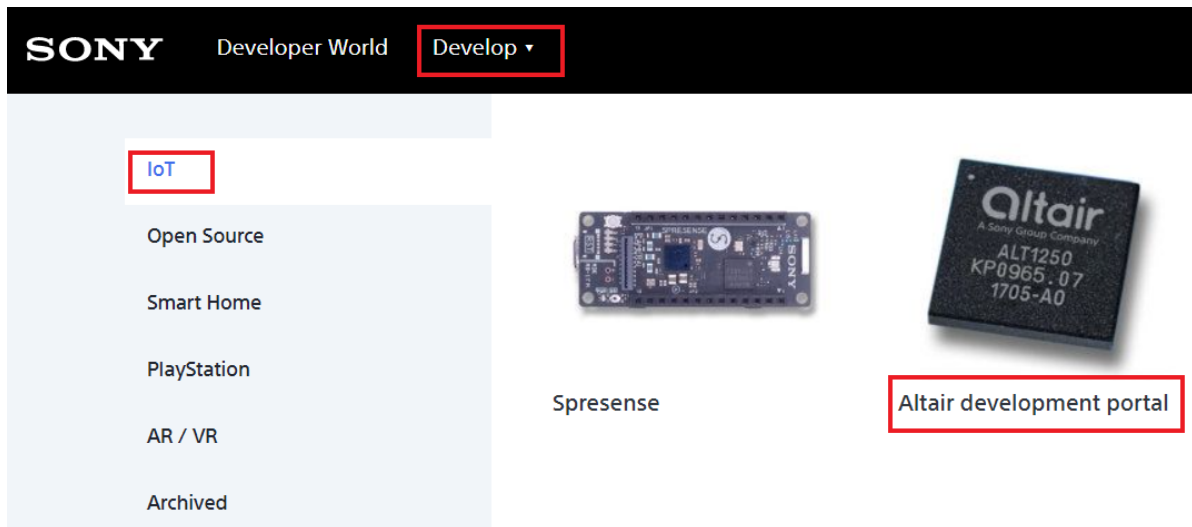

Figure 14: Adrastea-I: Sony MCU portal Access



Adrastea-I MCU is verified with Sony MCU SDK version 2.1.  
Refer documentation for MCU SDK version 2.1

- To access documentation of SDK version 2.1 click below link (Note: Login into portal is required to access below link).  
<https://bit.ly/3ld8kse>

## 6 Quick start guide

It is recommended to use the Adrastea-I evaluation kit and Adrastea Commander tool for putting the LTE-M/NB-IoT module into operation. The evaluation kit has external GNSS and LTE antennas. Please refer to the [?] for detailed information.

### 6.1 Minimal pin connections

The following image shows the steps to be performed to integrate the Adrastea-I into a custom end device.

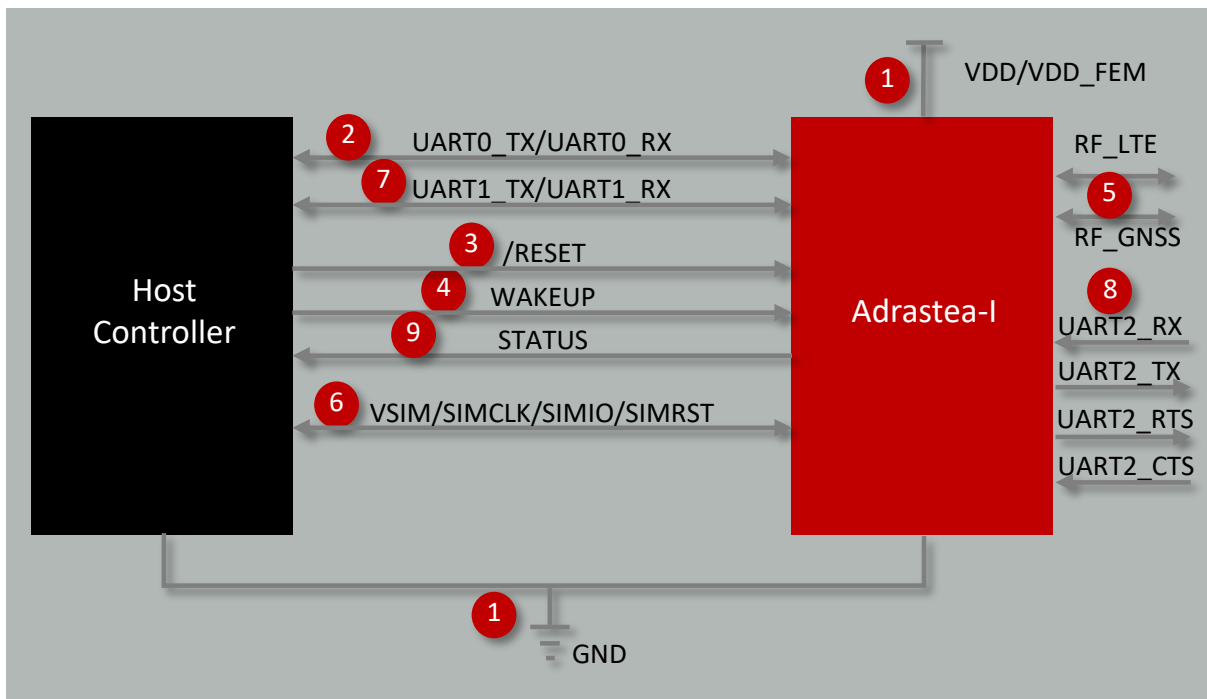

Figure 15: Minimal pin connections

**1. Supply voltage and ground**

Connect the *VDD*, *VDD\_FEM* and *GND* pins to supply the radio module with power.



Please note the minimum voltage acceptance difference between *VDD* and *VDD\_FEM*.

**2. MCU UART0 serial interface to the host**

Connect the UART pins *UART0\_RX* and *UART0\_TX* to the host to control the module via host controller.

**3. Reset**

Connect the */RESET* pin to the host to allow a hard reset of the module.

4. Wakeup  
Connect the *WAKEUP* pin to the host to allow the waking-up function of the module.
5. Antenna connection  
connect the *RF\_LTE* pin to an external LTE antenna. Connect the *RF\_LTE* pin to an external GNSS antenna.
6. SIM card connection  
connect the followings pins to a proper SIM card holder to allow network connection: *VSIM*, *SIMCLK*, *SIMIO* and *SIMRST*.
7. (Optional) MCU UART1 serial interface for modem logs  
Connect the UART pins *UART1\_RX* and *UART1\_TX* to obtain modem logs.
8. (Optional) MCU UART2 serial interface for firmware update  
Connect the UART pins *UART2\_RX*, *UART2\_TX*, *UART2\_CTS* and *UART2\_RTS* to execute firmware updates.
9. (Optional) Status indication  
Connect the *STATUS* pin to the host controller to allow easy indication of the status.



The logic level of the module is based on 1.8 V. A 3.3 V logic level shall not be connected directly to the digital interfaces of the module

If the module has to be connected to a PC, a converter (TTL to RS-232 or TTL to USB) has to be used. See chapter *Pinout* for details on all pins. Please refer to the Adrastea-I evaluation board schemes for a *Reference design*.

## 6.2 Prerequisites

1. Adrastea-I Evaluation Kit.
2. Computer with a serial terminal emulator. The use of Würth Elektronik eiSos's Adrastea Commander is recommended ([?]).
3. Install on your PC the corresponding FTDI driver package. Click on link 1 (FTDI drivers) in the "Adrastea Commander" tool or download direct from <https://www.ftdichip.com/Drivers/VCP.htm>.
4. A valid NB-IoT and LTE-M enabled nano SIM card. To order IoT SIM cards click on link 2 (Get your SIM card) in the "Adrastea Commander" tool or order directly from <https://iotcreators.com/wuerth/>.



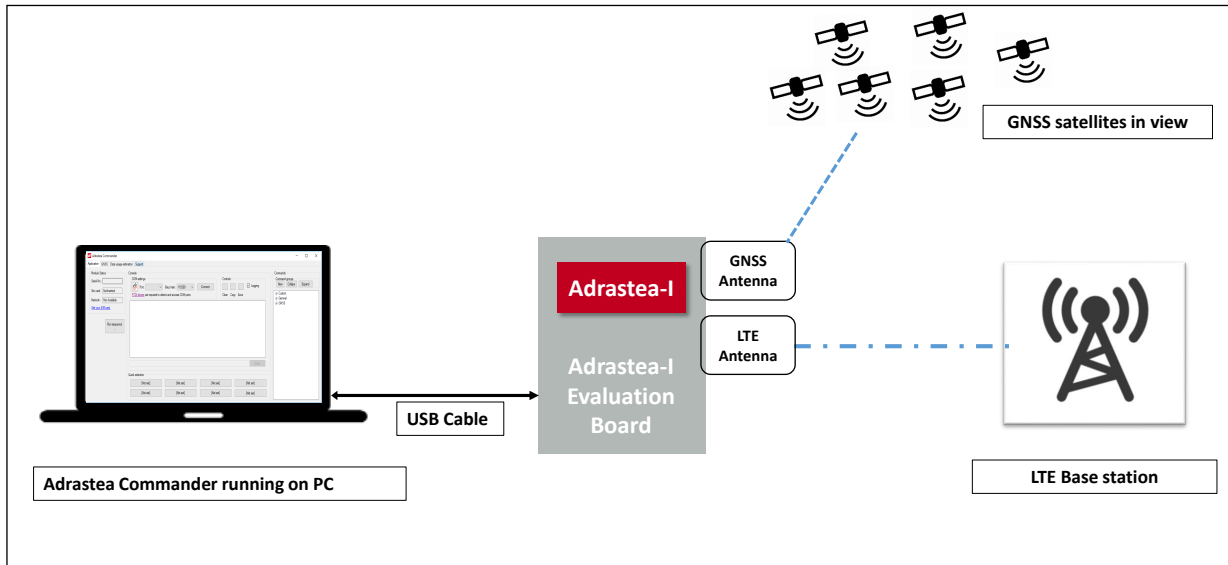

Figure 16: Adrastea Commander

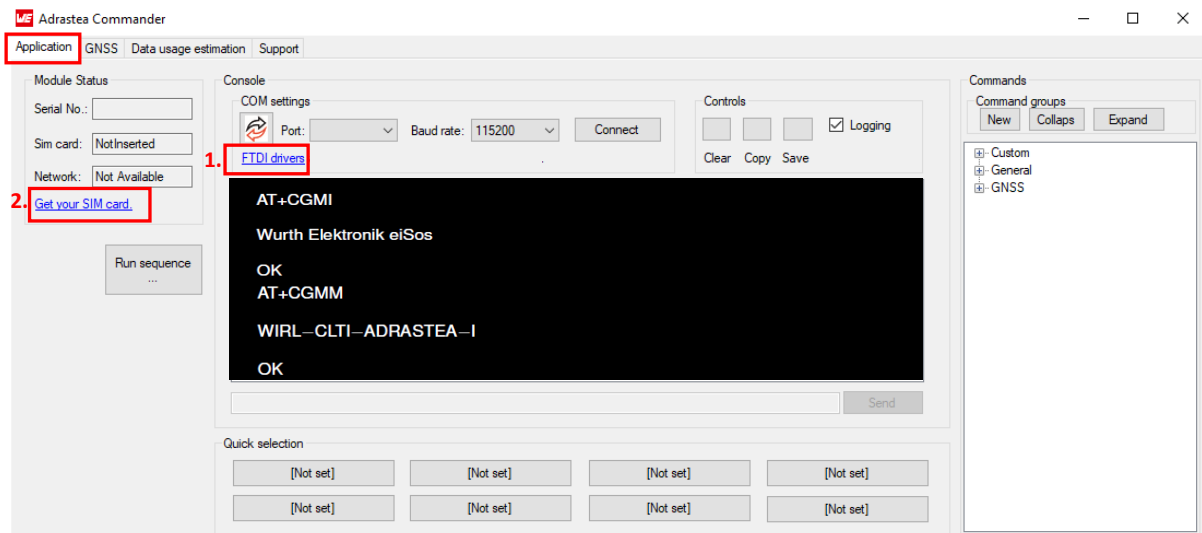

Figure 17: Adrastea Commander

### 6.3 Taking into operation

1. Insert a valid NB-IoT and LTE-M enabled nano SIM card.
2. Connect LTE and GNSS external antennas provided with the Evaluation Kit.
3. Connect the power jack or external power supply to the EV board and verify that the VDD is stable and able to reliably supply the module's static and peak current consumption, as specified in the data sheet and user manual.
4. Connect the evaluation board to the PC using a USB-cable. Four COM ports should be detected and installed on your PC. Check the device manager to acquire the COM port names of the EV board. A typical name is "COMxy" in Windows systems or /dev/ttyUSB0 in Linux systems.



Note that usually the four COM ports are assigned in ascending order, as shown in figure 18

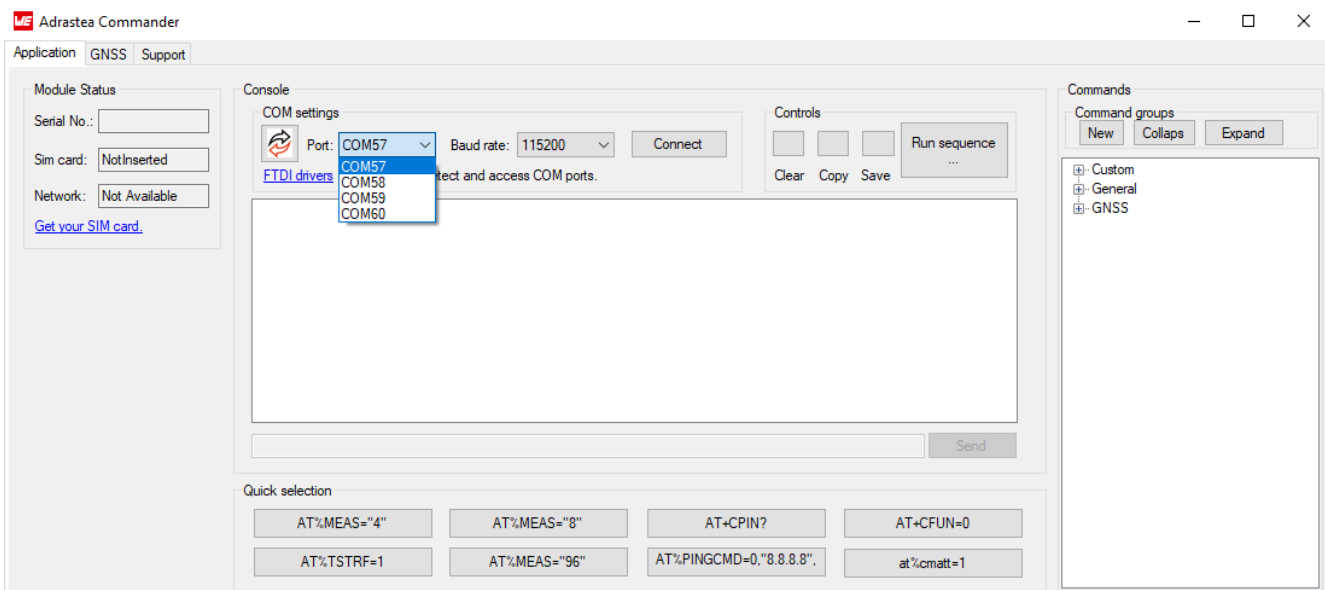

Figure 18: COM ports detected - Adrastea commander



To interact with the module, it is advised to use the Adrastea Commander tool. Otherwise, a terminal program (like "PuTTY" or "Tera Term" for Windows) has to be run and the corresponding COM port has to be opened using the default settings of the mounted Adrastea-I module.

5. Press the reset button on the Evaluation board to ensure a clean start-up of the module. See figure 19.
6. Type and enter the "map" command, this command is required before sending AT commands to modem.

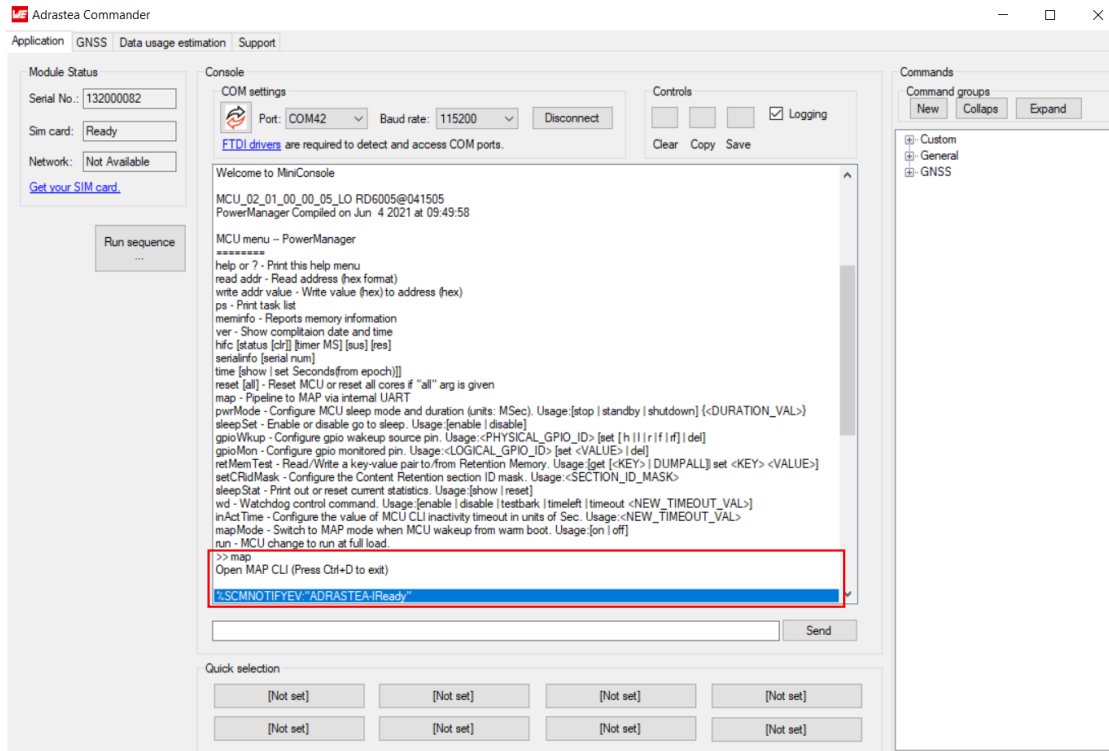

Figure 19: MiniConsole start view - Adrastea Commander



The "map" command is required before sending AT commands to modem.



When the AT Command UART port is opened, the Adrastea-I output console displays: %SCMNOTIFYEV:"ADRASTEAIReady".

7. Check if the SIM card is detected. Send command MAP follow by the command AT+CPIN?. See figure 20.

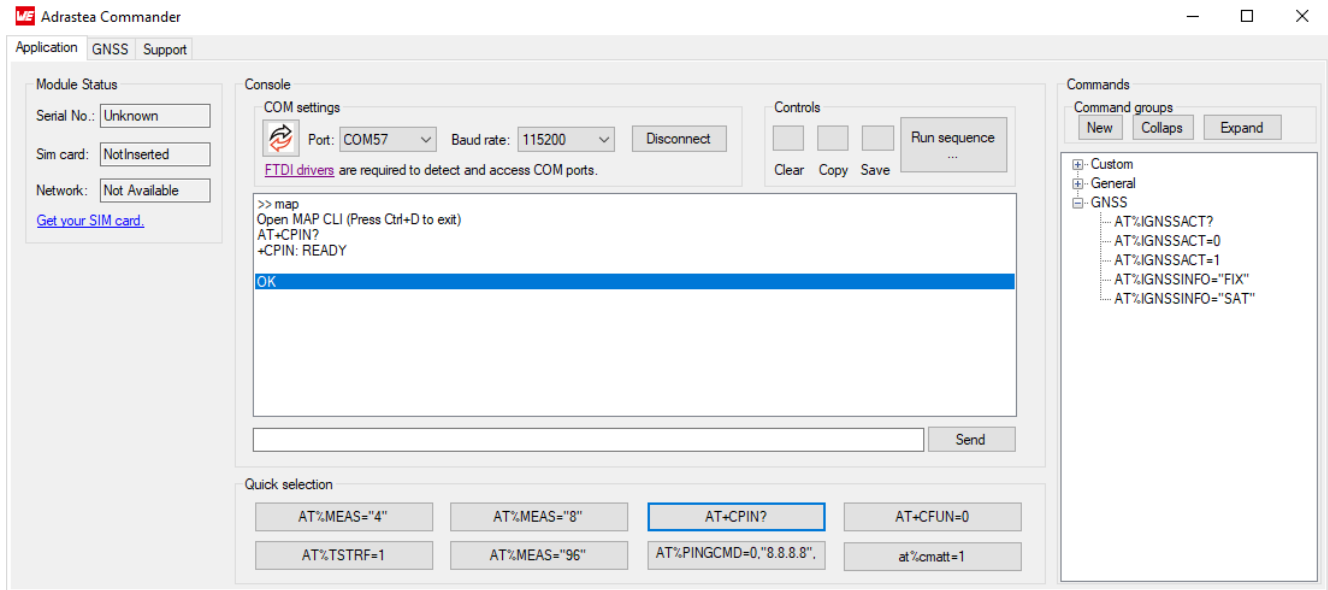

Figure 20: SIM card detected - Adrastea Commander

## 6.4 Select LTE-M or NB-IoT Mode

Adrastea-I supports AT Commands for LTE-M and NB-IoT selection. AT Command AT%RATACT is used to Switch/Select the LTE-M or NB-IoT.



Note: The default mode for the Adrastea-I module is LTE-M single mode



Any attempt to switch to the mode already in use will be ignored and OK will be returned.

### 1. Select Relevant RAT:

The following AT command will change the module mode to NB-IoT.

```
AT%RATACT="NBIOT",1  
OK
```

The following AT Command can be used to verify that NB-IoT has been selected.

```
AT%RATACT?  
%RATACT: "NBIOT",1,0  
OK
```

The following AT command will change the module mode to LTE-M.

```
AT%RATACT="CATM",1  
OK
```

The following AT Command can be used to verify that LTE-M. has been selected.

```
AT%RATACT?  
%RATACT: "CATM",1,0  
OK
```

### 2. Reset the device:

The following AT Command is used to reset the device.

```
ATZ  
  
OK
```

## 6.5 Register to Network



The configurations "Select LTE-M or NB-IoT Mode" (see Chapter 6.4) should be done before registering to the LTE network.



A valid LTE-M/NB-IoT SIM card should be inserted, check SIM status with AT+CPIN? AT Command.

The registration process in LTE-M and NB-IoT technologies could take some minutes to complete. This happens especially in case of the very first registration: new SIM, new location, new module. This is because of scanning of available frequencies and selection of a suitable frequency.

1. Check SIM status:

The following command is used to read the SIM status.

```
AT+CPIN?  
  
+CPIN: READY  
OK
```

2. To start the registration procedure:

The following command will trigger the registration procedure with the network.

```
AT%CMATT=1  
  
OK
```

3. Enable network registration unsolicited result code:  
The following command will enable network registration and location information unsolicited result code.

```
AT+CEREG=2  
  
OK
```

4. Read the network registration status:

The following command will read the network registration status.

```
AT+CEREG?  
+CEREG: 2,5,"CB48","01CD6007",9  
OK
```

The following command will trigger the de-registration procedure with the network.

```
AT%CMATT=0  
  
OK
```

## 6.6 Activate GNSS

This section shows how to enable the GNSS feature of the Adrastea-I module.



GNSS cannot co-exist with LTE data transfer. LTE communication has higher priority over GNSS and, therefore, GNSS is automatically shut down once LTE is active (if it was active). While LTE is active, GNSS cannot be activated and all GNSS AT commands are responded with error.

1. Disable LTE prior to activating GNSS:

The following command will disable LTE radio.

```
AT+CFUN=0  
  
OK
```

2. Allow unsolicited notifications:

```
AT%!GNSSEV="SESSIONSTAT",1  
  
OK
```

3. Get available satellites:



It is necessary to check that there are at least 4 satellites available with an SNR>25.

```
AT%IGNSSINFO="SAT"  
%IGNSSINFO: 11  
%IGNSSINFO:03,36,294,49  
%IGNSSINFO:06,53,263,50  
%IGNSSINFO:14,42,180,50  
%IGNSSINFO:15,13,042,50  
%IGNSSINFO:16,08,251,50  
%IGNSSINFO:18,56,044,50  
%IGNSSINFO:19,25,314,50  
%IGNSSINFO:21,46,104,51  
%IGNSSINFO:22,71,306,49  
%IGNSSINFO:24,14,080,49  
%IGNSSINFO:27,51,282,50
```

4. Enable NMEA sentences (This command is required only when messages are required in GNSS tab of Adrastea Commander tool):

```
AT%IGNSSCFG="SET","NMEA","GGA","GSA","GSV","GNS","RMC"  
  
OK
```

5. Start GNSS:



For first time GNSS fix, cold start should be triggered to start GNSS

The following command is used for cold GNSS start.

```
AT%IGNSSACT=1,1  
  
OK
```

The following command is used for hot GNSS Start.

```
AT%IGNSSACT=1,2  
  
OK
```

6. Get fix:

```
AT%IGNSSINFO="FIX"  
  
%IGNSSINFO: 2,"11:17:02","04/05/2020","32.195970","34.892572","  
-10.500000",1588580222000,1,"0.000000","B"
```



The following AT command is used to stop GNSS functionality:

```
AT%IGNSSACT=0
```

```
OK
```

## 7 Design in guide

### 7.1 Advice for schematic and layout

For users with less RF experience it is advisable to closely copy the relating evaluation board with respect to schematic and layout, as it is a proven design. The layout should be conducted with particular care, because even small deficiencies could affect the radio performance and its range or even the conformity.

The following general advice should be taken into consideration:

- A clean, stable power supply is strongly recommended. Interference, especially oscillation can severely restrain range and conformity.
- Variations in voltage level should be avoided.
- LDOs, properly designed in, usually deliver a proper regulated voltage.
- Blocking capacitors and a ferrite bead in the power supply line can be included to filter and smoothen the supply voltage when necessary.



No fixed values can be recommended, as these depend on the circumstances of the application (main power source, interferences etc.).



The use of an external reset IC should be considered if one of the following points is relevant:



- The slew rate of the power supply exceeds the electrical specifications.
- The effect of different current consumptions on the voltage level of batteries or voltage regulators should be considered. The module draws higher currents in certain scenarios like start-up or radio transmit which may lead to a voltage drop on the supply. A restart under such circumstances should be prevented by ensuring that the supply voltage does not drop below the minimum specifications.
- Voltage levels below the minimum recommended voltage level may lead to malfunction. The /Reset pin of the module shall be held on LOW logic level whenever the VCC is not stable or below the minimum operating Voltage.
- Special care must be taken in case of battery powered systems.

- Elements for ESD protection should be placed on all pins that are accessible from the outside and should be placed close to the accessible area. For example, the RF-pin is accessible when using an external antenna and should be protected.
- ESD protection for the antenna connection must be chosen such as to have a minimum effect on the RF signal. For example, a protection diode with low capacitance such as the 8231706A or a 68 nH air-core coil connecting the RF-line to ground give good results.
- Placeholders for optional antenna matching or additional filtering are recommended.
- The antenna path should be kept as short as possible.



Again, no fixed values can be recommended, as they depend on the influencing circumstances of the application (antenna, interferences etc.).

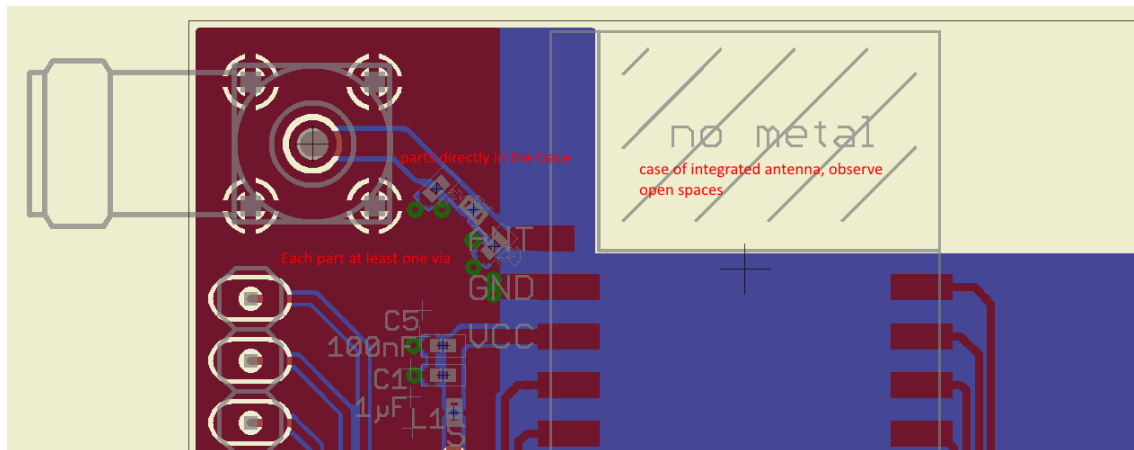

Figure 21: Layout

- To avoid the risk of short circuits and interference there should be only the necessary routing underneath the module on the top layer of the baseboard.
- On the second layer, a ground plane is recommended, to provide good grounding and shielding to any following layers and application environment.
- Filter and blocking capacitors should be placed directly in the tracks without stubs, to achieve the best effect.
- Antenna matching elements should be placed close to the antenna / connector, blocking capacitors close to the module.
- Ground connections for the module and the capacitors should be kept as short as possible and with at least one separate through hole connection to the ground layer.
- ESD protection elements should be placed as close as possible to the exposed areas.

## 7.2 Dimensioning of the micro strip antenna line

The antenna track has to be designed as a 50 Ω feed line. The width W for a micro strip can

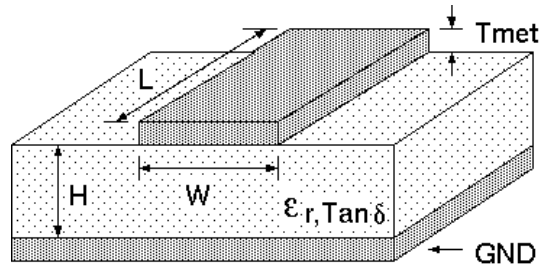

Figure 22: Dimensioning the antenna feed line as micro strip

be calculated using the following equation:

$$W = 1.25 \times \left( \frac{5.98 \times H}{e^{\frac{50 \times \sqrt{\epsilon_r + 1.41}}{87}}} - T_{met} \right) \quad (1)$$

Example:

A FR4 material with  $\epsilon_r = 4.3$ , a height  $H = 1000 \mu\text{m}$  and a copper thickness of  $T_{met} = 18 \mu\text{m}$  will lead to a trace width of  $W \sim 1.9 \text{ mm}$ . To ease the calculation of the micro strip line (or e.g. a coplanar) many calculators can be found in the internet.

- As rule of thumb a distance of about  $3 \times W$  should be observed between the micro strip and other traces / ground.
- The micro strip refers to ground, therefore there has to be the ground plane underneath the trace.
- Keep the feeding line as short as possible.

## 7.3 Antenna solutions

There exist several kinds of antennas, which are optimized for different needs. Chip antennas are optimized for minimal size requirements but at the expense of range, PCB antennas are optimized for minimal costs, and are generally a compromise between size and range. Both usually fit inside a housing.

Range optimization in general is at the expense of space. Antennas that are bigger in size, so that they would probably not fit in a small housing, are usually equipped with a RF connector. A benefit of this connector may be to use it to lead the RF signal through a metal plate (e.g. metal housing, cabinet).

As a rule of thumb a minimum distance of  $\lambda / 10$  (which is 3.5 cm @ 868 MHz and 1.2 cm @ 2.44 GHz) from the antenna to any other metal should be kept. Metal placed further away will not directly influence the behavior of the antenna, but will anyway produce shadowing.



Keep the antenna as far as possible from large metal objects to avoid electro-magnetic field blocking.



The choice of antenna might have influence on the safety requirements.

In the following chapters, some special types of antenna are described.

### **7.3.1 Wire antenna**

An effective antenna is a  $\lambda / 4$  radiator with a suiting ground plane. The simplest realization is a piece of wire. It's length is depending on the used radio frequency, so for example 8.6 cm 868.0 MHz and 3.1 cm for 2.440 GHz as frequency. This radiator needs a ground plane at its feeding point. Ideally, it is placed vertically in the middle of the ground plane. As this is often not possible because of space requirements, a suitable compromise is to bend the wire away from the PCB respective to the ground plane. The  $\lambda/4$  radiator has approximately 40  $\Omega$  input impedance. Therefore, matching is not required.

### **7.3.2 Chip antenna**

There are many chip antennas from various manufacturers. The benefit of a chip antenna is obviously the minimal space required and reasonable costs. However, this is often at the expense of range. For the chip antennas, reference designs should be followed as closely as possible, because only in this constellation can the stated performance be achieved.

### **7.3.3 PCB antenna**

PCB antenna designs can be very different. The special attention can be on the miniaturization or on the performance. The benefits of the PCB antenna are their small / not existing (if PCB space is available) costs, however the evaluation of a PCB antenna holds more risk of failure than the use of a finished antenna. Most PCB antenna designs are a compromise of range and space between chip antennas and connector antennas.

## 8 Reference design

Adrastea-I was tested on the evaluation board which serves as reference design. Further information concerning the use of the evaluation board can be found in the manual of the Adrastea-I evaluation board [?].

### 8.1 Schematic

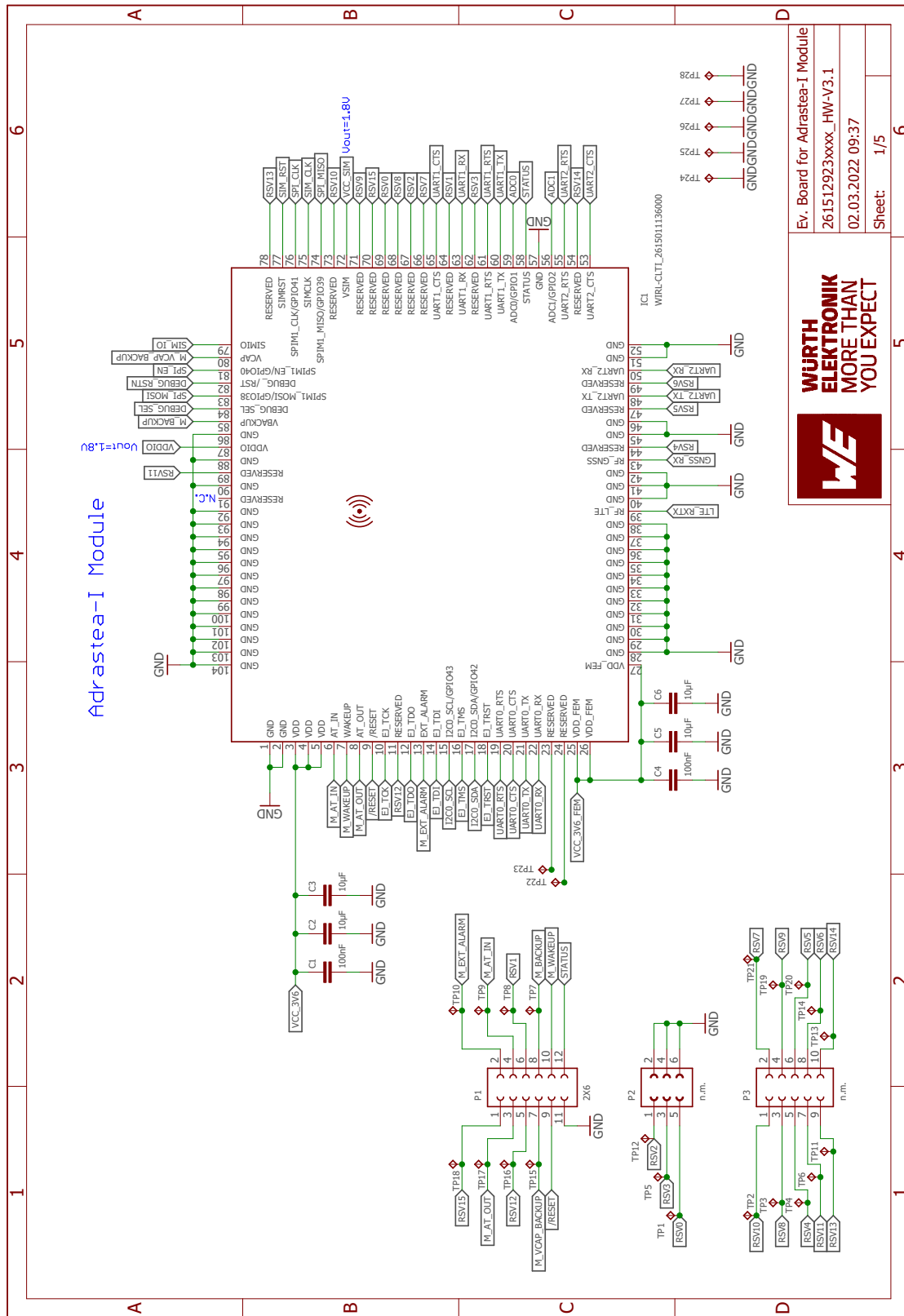
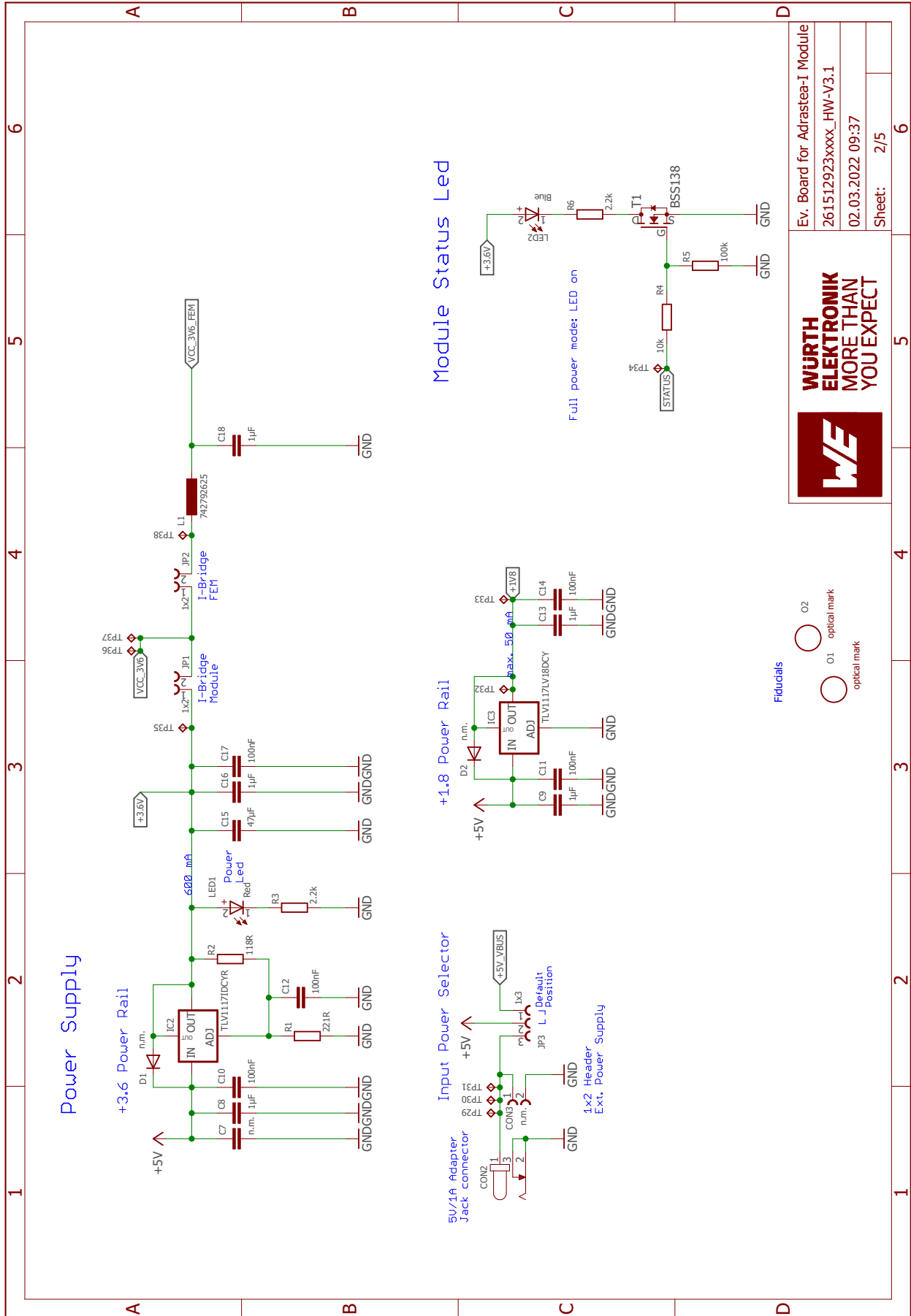

Figure 23: Circuit diagram 1



Ev. Board for Adrastea-I Module  
 261512923xxxx\_HW-V3.1  
 02.03.2022 09:37  
 Sheet: 2/5



Fiducials  
 ○ 02  
 ○ 01 optical mark

Figure 24: Circuit diagram 2



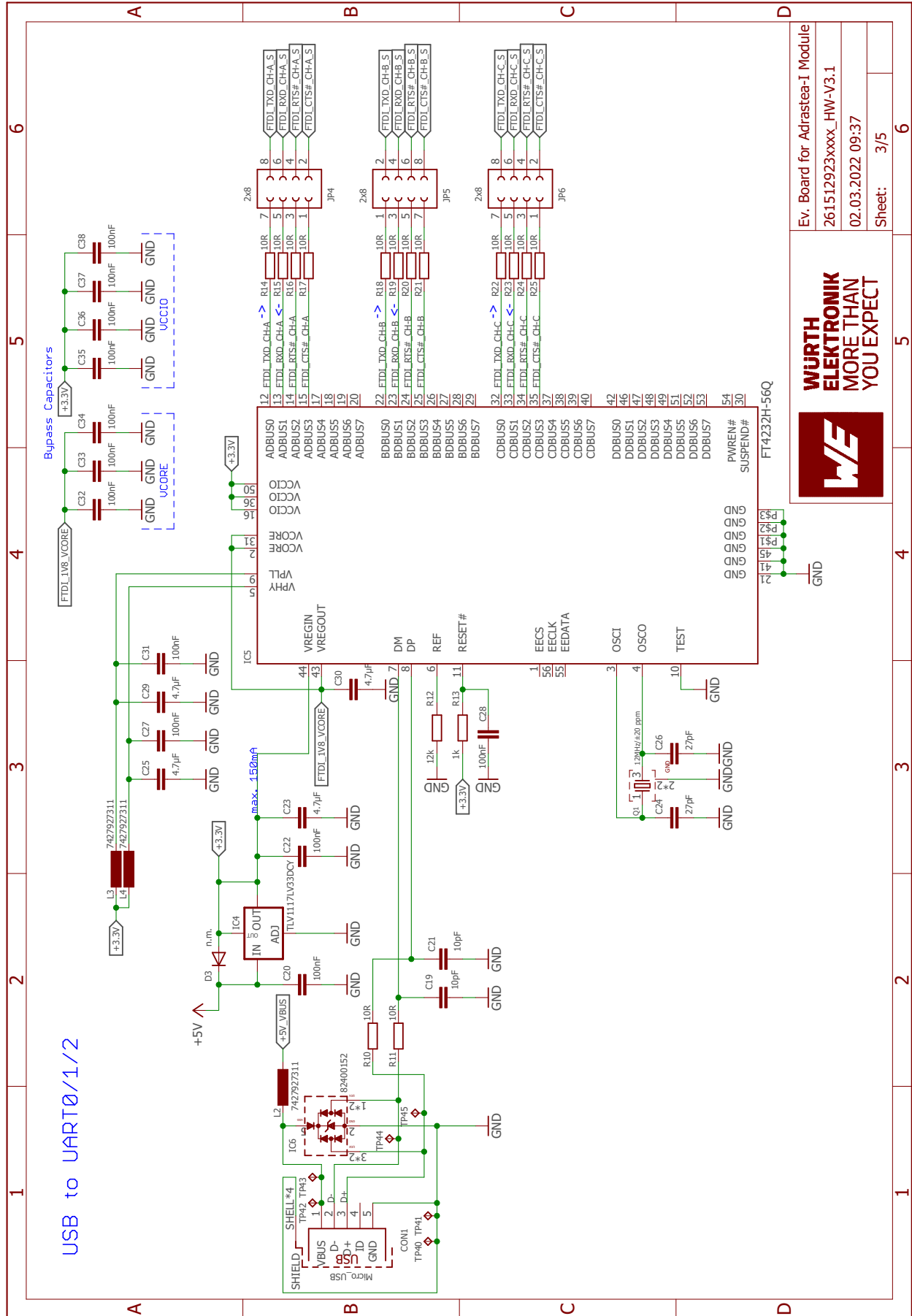
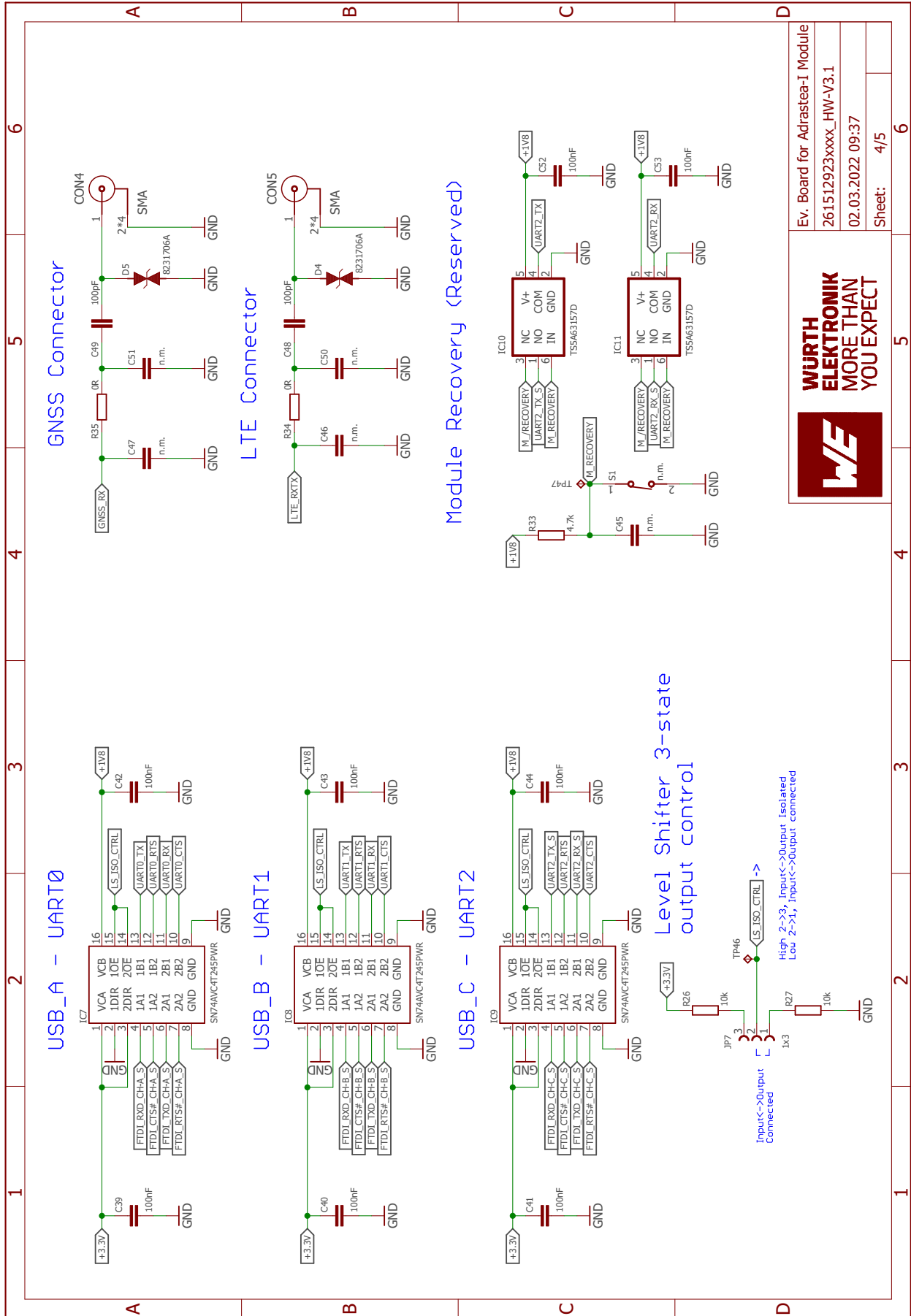

Figure 25: Circuit diagram 3

WURTH ELEKTRONIK  
MORE THAN YOU EXPECT

Ev. Board for Adrastea-I Module  
261512923xxxx\_HW-V3.1  
02.03.2022 09:37  
Sheet: 3/5



WURTH  
ELEKTRONIK  
MORE THAN  
YOU EXPECT

Ev. Board for Adrastea-I Module  
261512923xxxx\_HW-V3.1  
02.03.2022 09:37  
Sheet: 4/5

Figure 26: Circuit diagram 4

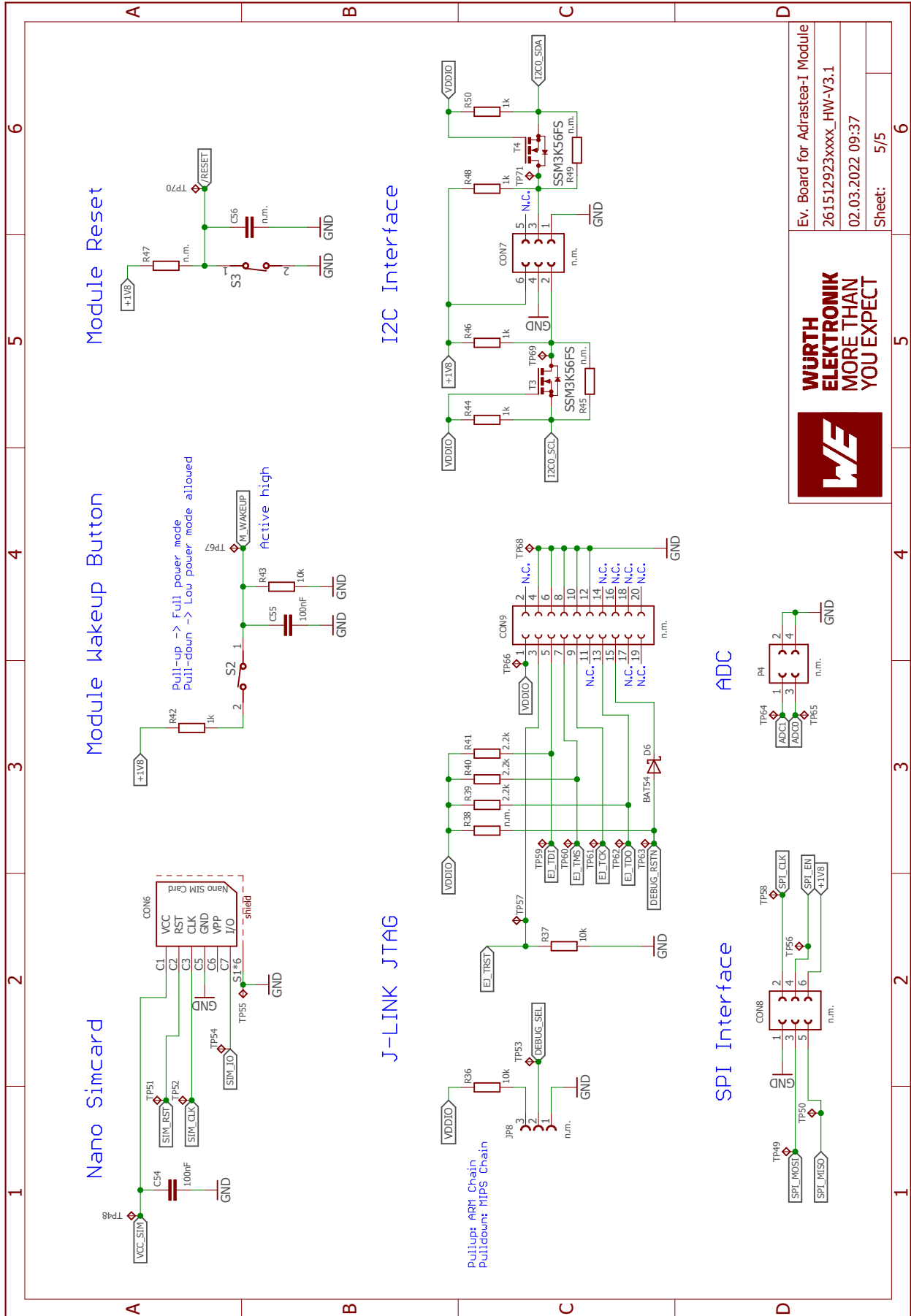

**WURTH ELEKTRONIK**  
MORE THAN YOU EXPECT

Ev. Board for Adrastea-I Module  
261512923xxxx\_HW-V3.1  
02.03.2022 09:37  
Sheet: 5/5

Figure 27: Circuit diagram 5

**8.2 Layout**

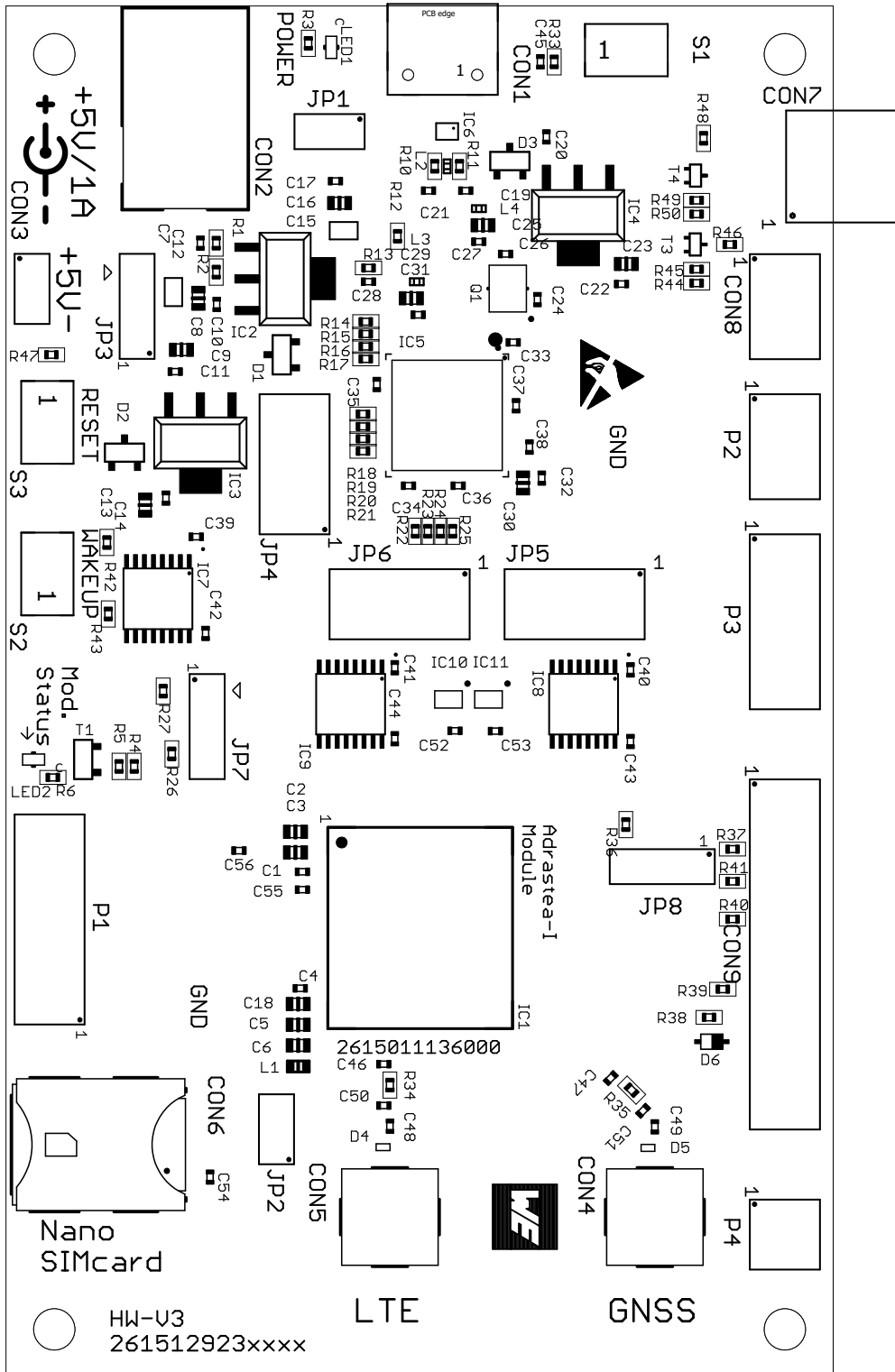

Figure 28: Assembly diagram

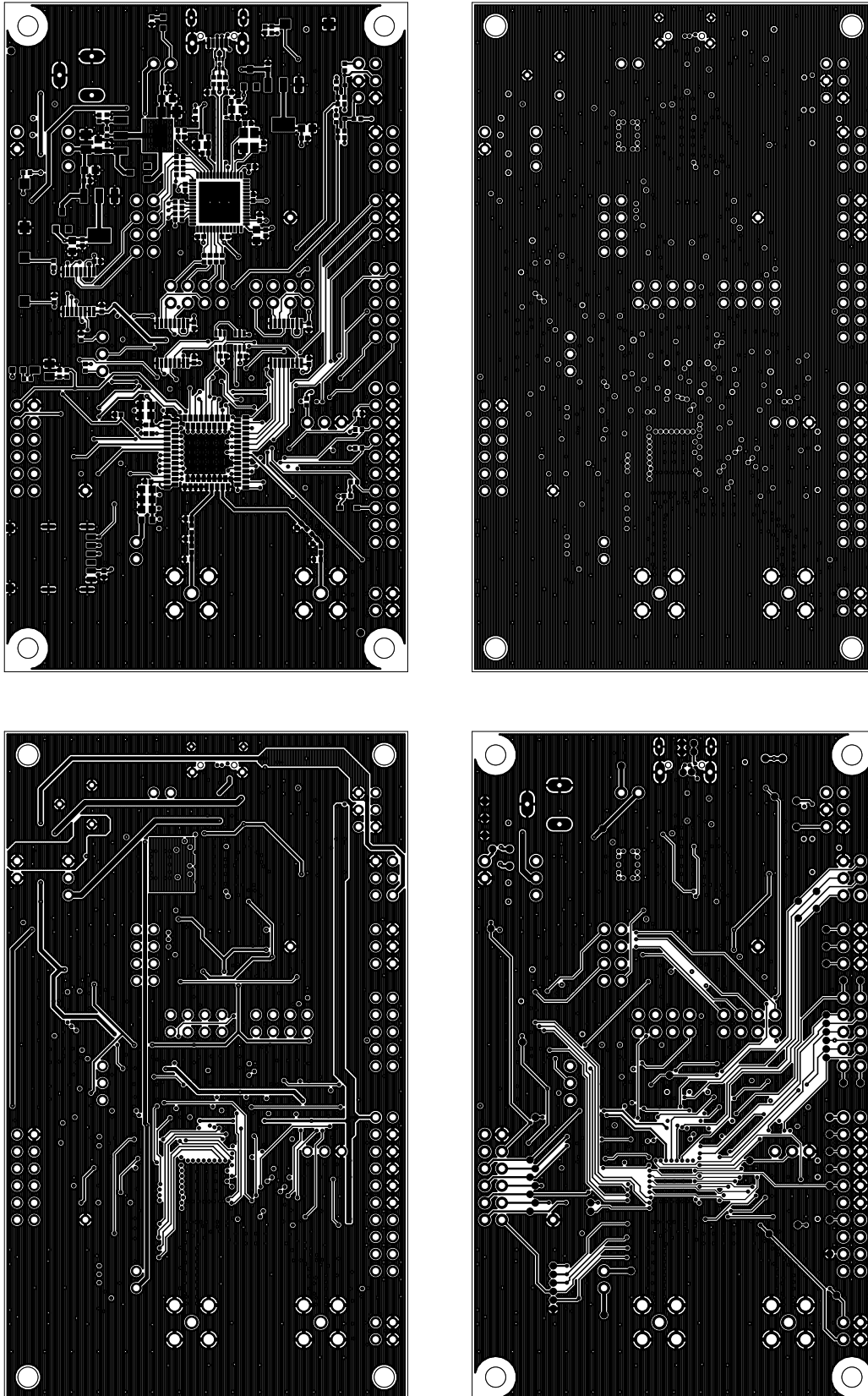

Figure 29: Top layer (upper left), second layer (upper right), third layer (bottom left), fourth layer (bottom right)

## 9 Manufacturing information

### 9.1 Moisture sensitivity level

This wireless connectivity product is categorized as JEDEC Moisture Sensitivity Level 3 (MSL3), which requires special handling.

More information regarding the MSL requirements can be found in the IPC/JEDEC J-STD-020 standard on [www.jedec.org](http://www.jedec.org).

More information about the handling, picking, shipping and the usage of moisture/reflow and/or process sensitive products can be found in the IPC/JEDEC J-STD-033 standard on [www.jedec.org](http://www.jedec.org).

### 9.2 Soldering

#### 9.2.1 Reflow soldering

Attention must be paid on the thickness of the solder resist between the host PCB top side and the modules bottom side. Only lead-free assembly is recommended according to JEDEC J-STD020.

Profile feature		Value
Preheat temperature Min	$T_{S \text{ Min}}$	150 °C
Preheat temperature Max	$T_{S \text{ Max}}$	200 °C
Preheat time from $T_{S \text{ Min}}$ to $T_{S \text{ Max}}$	$t_S$	60 - 120 seconds
Ramp-up rate ( $T_L$ to $T_P$ )		3 °C / second max.
Liquidous temperature	$T_L$	217 °C
Time $t_L$ maintained above $T_L$	$t_L$	60 - 150 seconds
Peak package body temperature	$T_P$	see table below
Time within 5 °C of actual peak temperature	$t_P$	20 - 30 seconds
Ramp-down Rate ( $T_P$ to $T_L$ )		6 °C / second max.
Time 20 °C to $T_P$		8 minutes max.

Table 41: Classification reflow soldering profile, Note: refer to IPC/JEDEC J-STD-020E

Package thickness	Volume mm <sup>3</sup> <350	Volume mm <sup>3</sup> 350-2000	Volume mm <sup>3</sup> >2000
< 1.6 mm	260 °C	260 °C	260 °C
1.6 mm - 2.5 mm	260 °C	250 °C	245 °C
> 2.5 mm	250 °C	245 °C	245 °C

Table 42: Package classification reflow temperature, PB-free assembly, Note: refer to IPC/-JEDEC J-STD-020E

It is recommended to solder this module on the last reflow cycle of the PCB. For solder paste use a LFM-48W or Indium based SAC 305 alloy (Sn 96.5 / Ag 3.0 / Cu 0.5 / Indium 8.9HF / Type 3 / 89%) type 3 or higher.

The reflow profile must be adjusted based on the thermal mass of the entire populated PCB, heat transfer efficiency of the reflow oven and the specific type of solder paste used. Based on the specific process and PCB layout the optimal soldering profile must be adjusted and verified. Other soldering methods (e.g. vapor phase) have not been verified and have to be validated by the customer at their own risk. Rework is not recommended.

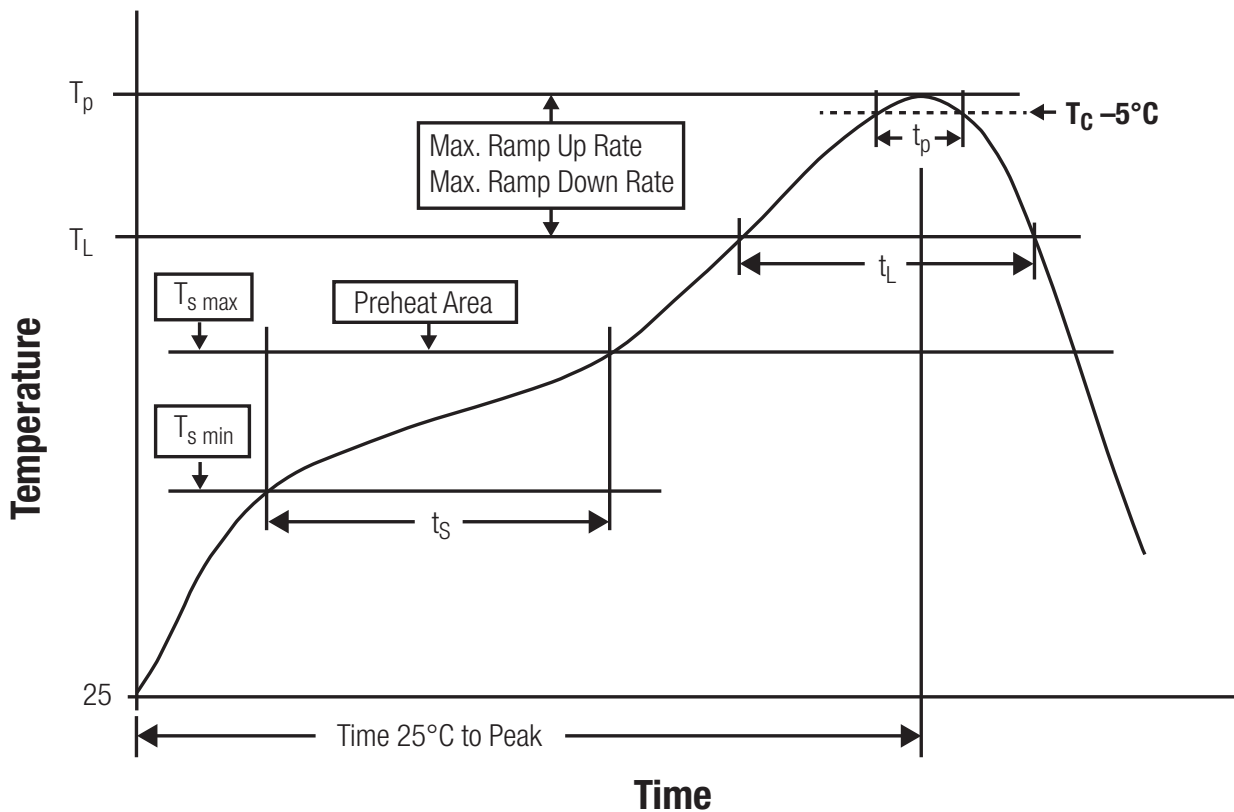

Figure 30: Reflow soldering profile

After reflow soldering, visually inspect the board to confirm proper alignment

### 9.2.2 Cleaning

Do not clean the product. Any residue cannot be easily removed by washing. Use a "no clean" soldering paste and do not clean the board after soldering.

- Do not clean the product with water. Capillary effects can draw water into the gap between the host PCB and the module, absorbing water underneath it. If water is trapped inside, it may short-circuit adjoining pads. The water may also destroy the label and ink-jet printed text on it.
- Cleaning processes using alcohol or other organic solvents may draw solder flux residues into the housing, which won't be detected in a post-wash inspection. The solvent may also destroy the label and ink-jet printed text on it.
- Do not use ultrasonic cleaning as it will permanently damage the part, particularly the crystal oscillators.

### 9.2.3 Potting and coating

- If the product is potted in the customer application, the potting material might shrink or expand during and after hardening. Shrinking could lead to an incomplete seal, allowing contaminants into the component. Expansion could damage components. We recommend a manual inspection after potting to avoid these effects.
- Conformal coating or potting results in loss of warranty.
- The RF shield will not protect the part from low-viscosity coatings and potting. An undefined amount of coating and potting will enter inside the shielding.
- Conformal coating and potting will influence the parts of the radio front end and consequently influence the radio performance.
- Potting will influence the temperature behaviour of the device. This might be critical for components with high power.

### 9.2.4 Other notations

- Do not attempt to improve the grounding by forming metal strips directly to the EMI covers or soldering on ground cables, as it may damage the part and will void the warranty.
- Always solder every pad to the host PCB even if some are unused, to improve the mechanical strength of the module.
- The part is sensitive to ultrasonic waves, as such do not use ultrasonic cleaning, welding or other processing. Any ultrasonic processing will void the warranty.



### 9.3 ESD handling

This product is highly sensitive to electrostatic discharge (ESD). As such, always use proper ESD precautions when handling. Make sure to handle the part properly throughout all stages of production, including on the host PCB where the module is installed. For ESD ratings, refer to the module series' maximum ESD section. For more information, refer to the relevant chapter 2. Failing to follow the aforementioned recommendations can result in severe damage to the part.

- the first contact point when handling the PCB is always between the local GND and the host PCB GND, unless there is a galvanic coupling between the local GND (for example work table) and the host PCB GND.
- Before assembling an antenna patch, connect the grounds.
- While handling the RF pin, avoid contact with any charged capacitors and be careful when contacting any materials that can develop charges (for example coaxial cable with around 50-80 pF/m, patch antenna with around 10 pF, soldering iron etc.)
- Do not touch any exposed area of the antenna to avoid electrostatic discharge. Do not let the antenna area be touched in a non ESD-safe manner.
- When soldering, use an ESD-safe soldering iron.

### 9.4 Safety recommendations

It is your duty to ensure that the product is allowed to be used in the destination country and within the required environment. Usage of the product can be dangerous and must be tested and verified by the end user. Be especially careful of:

- Use in areas with risk of explosion (for example oil refineries, gas stations).
- Use in areas such as airports, aircraft, hospitals, etc., where the product may interfere with other electronic components.

It is the customer's responsibility to ensure compliance with all applicable legal, regulatory and safety-related requirements as well as applicable environmental regulations. Disassembling the product is not allowed. Evidence of tampering will void the warranty.

- Compliance with the instructions in the product manual is recommended for correct product set-up.
- The product must be provided with a consolidated voltage source. The wiring must meet all applicable fire and security prevention standards.
- Handle with care. Avoid touching the pins as there could be ESD damage.

Be careful when working with any external components. When in doubt consult the technical documentation and relevant standards. Always use an antenna with the proper characteristics.



Würth Elektronik eiSos radio modules with high output power of up to 500 mW, as for example the radio module Thebe-II, generate a high amount of warmth while transmitting. The manufacturer of the end device must take care of potentially necessary actions for his application.

## 10 Physical specifications

### 10.1 Dimensions

Dimensions
13.4 * 14.6 * 1.85 mm

Table 43: Dimensions

Tolerances: see chapter 10.3

### 10.2 Weight

Weight
0.80 g

Table 44: Weight

Tolerance:  $\pm 0.15$  g

### 10.3 Module drawing

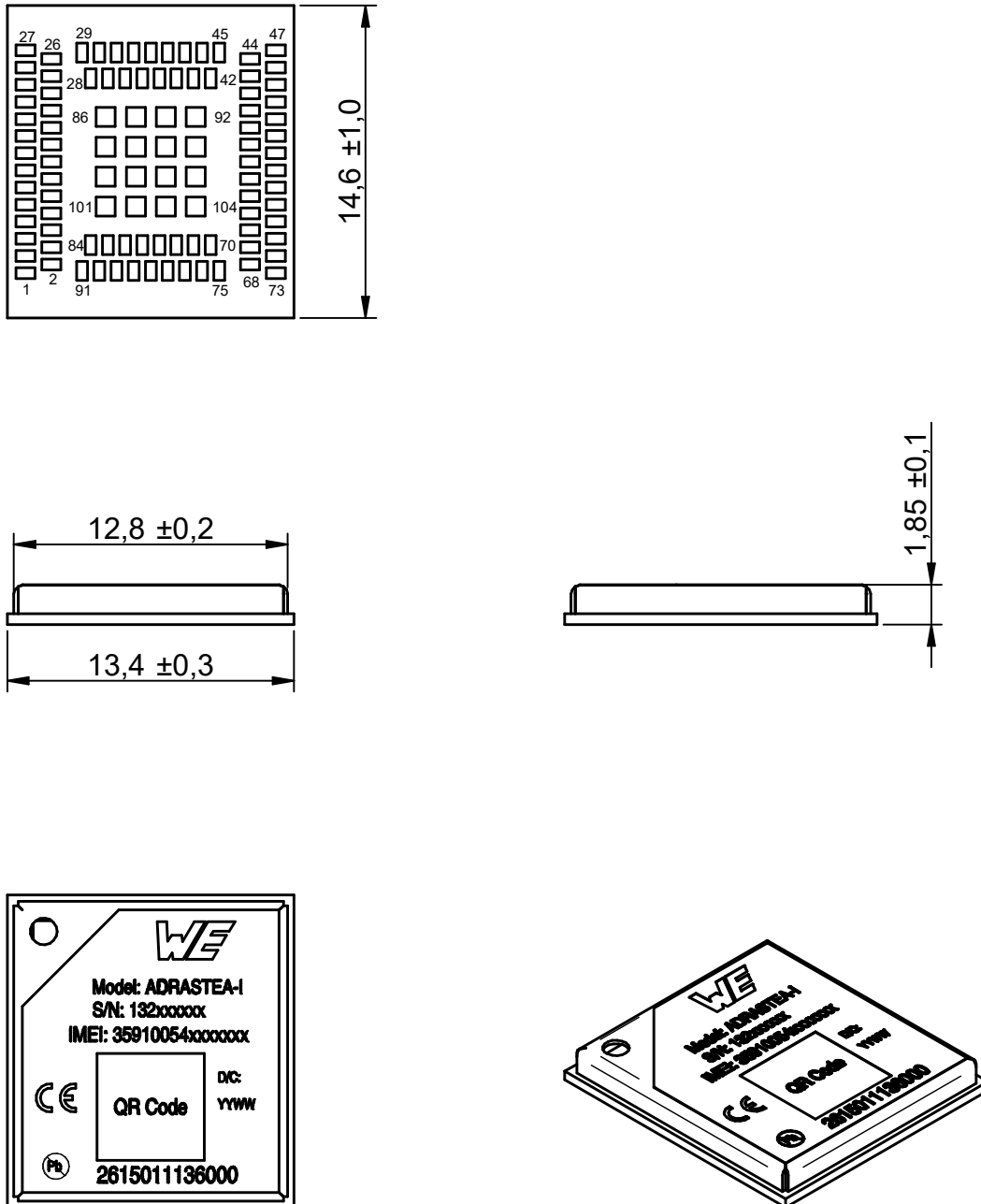

Figure 31: Module dimensions [mm]

## 10.4 Footprint

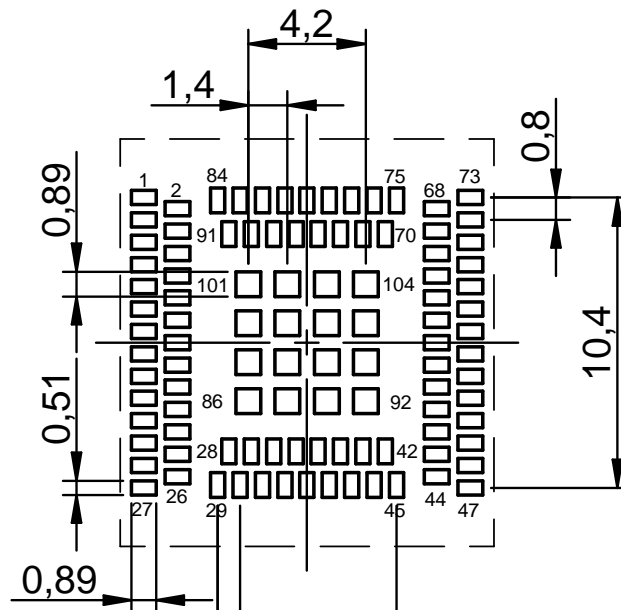

Figure 32: Footprint and dimensions [mm]

# 11 Marking

## 11.1 Lot number

The 15 digit lot number is printed in numerical digits as well as in form of a machine readable bar code. It is divided into 5 blocks as shown in the following picture and can be translated according to the following table.

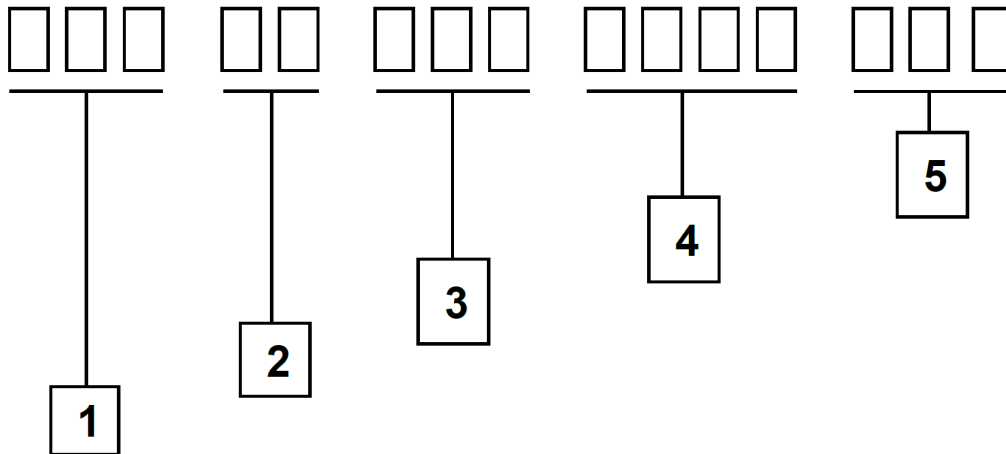

Figure 33: Lot number structure

Block	Information	Example(s)
1	eiSos internal, 3 digits	439
2	eiSos internal, 2 digits	01
3	Hardware version, 3 digits	V2.4 = 024, V12.2 = 122
4	Date code, 4 digits	1703 = week 03 in year 2017, 1816 = week 16 in year 2018
5	Firmware version, 3 digits	V3.2 = 302, V5.13 = 513

Table 45: Lot number details

As the user can perform a firmware update the printed lot number only shows the factory delivery state. The currently installed firmware can be requested from the module using the corresponding product specific command. The firmware version as well as the hardware version are restricted to show only major and minor version not the patch identifier.

## 11.2 General labeling information

The module labels may include the following fields:

- Manufacturer identification WE, Würth Elektronik or Würth Elektronik eiSos
- WE Order Code and/or article alias
- Serial number or MAC address
- Certification identifiers (CE, FCC ID, IC, TELEC,...)
- Bar code or 2D code containing the serial number or MAC address

If the module is using a serial Number, this serial number includes the product ID (PID) and an 6 digit number. The 6 rightmost digits represent the 6 digit number, followed by the product ID (2 or 3 digits). Some labels indicate the product ID with a "." as marker in-between the 2 fields. The PID and the 6 digit number form together a unique serial number for any wireless connectivity product.

In case of small labels, the 3 byte manufacturer identifier (0x0018DA) of the MAC address is not printed on the labels. The 3 byte counter printed on the label can be used with this 0018DA to produce the full MAC address by appending the counter after the manufacturer identifier.

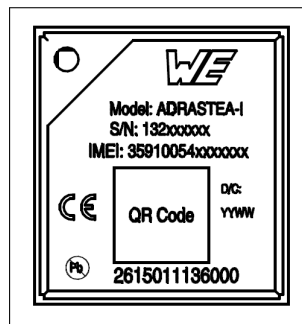

Figure 34: Label of the Adrastea-I

## 12 References



## 13 Regulatory compliance information

### 13.1 Important notice EU

The use of RF frequencies is limited by national regulations. The Adrastea-I has been designed to comply with the RED directive 2014/53/EU of the European Union (EU).

The Adrastea-I can be operated without notification and free of charge in the area of the European Union. However, according to the RED directive, restrictions (e.g. in terms of duty cycle or maximum allowed RF power) may apply.



Since the module is a built-in equipment its power class according to EN 62368-1 must be specified in the end product.

### 13.2 Conformity assessment of the final product

The Adrastea-I is a subassembly. It is designed to be embedded into other products (products incorporating the Adrastea-I are henceforward referred to as "final products").

It is the responsibility of the manufacturer of the final product to ensure that the final product is in compliance with the essential requirements of the underlying national radio regulations.

The conformity assessment of the subassembly Adrastea-I carried out by Würth Elektronik eiSos does not replace the required conformity assessment of the final product.

### 13.3 Exemption clause

Relevant regulation requirements are subject to change. Würth Elektronik eiSos does not guarantee the accuracy of the before mentioned information. Directives, technical standards, procedural descriptions and the like may be interpreted differently by the national authorities. Equally, the national laws and restrictions may vary with the country. In case of doubt or uncertainty, we recommend that you consult with the authorities or official certification organizations of the relevant countries. Würth Elektronik eiSos is exempt from any responsibilities or liabilities related to regulatory compliance.

Notwithstanding the above, Würth Elektronik eiSos makes no representations and warranties of any kind related to their accuracy, correctness, completeness and/or usability for customer applications. No responsibility is assumed for inaccuracies or incompleteness.

## 13.4 EU Declaration of conformity



### EU DECLARATION OF CONFORMITY

**Radio equipment:**      **Adrastea-I**

**The manufacturer:**    Würth Elektronik eiSos GmbH & Co. KG  
Max-Eyth-Straße 1  
74638 Waldenburg

This declaration of conformity is issued under the sole responsibility of the manufacturer.

### Object of the declaration: Adrastea-I

The object of the declaration described above is in conformity with the relevant Union harmonisation legislation Directive 2014/53/EU and 2011/65/EU with its amending Annex II EU 2015/863. Following harmonised norms or technical specifications have been applied:

EN 301 908-1 V15.2.1 (2023-01)  
EN 301 908-13 V13.2.1 (2022-02)  
EN 303 413 V1.2.1 (2021-04)  
EN 301 489-1 V2.2.3 (2019-11)  
EN 301 489-19 V2.1.1 (2019-04)  
EN 62311: 2008  
EN 62368-1: 2014/AC: 2015/A11: 2017

*i.A. G. Eslerdt*

Trier, 25th of August 2023

Place and date of issue

## **14 Important notes**

The following conditions apply to all goods within the wireless connectivity product range of Würth Elektronik eiSos GmbH & Co. KG:

### **14.1 General customer responsibility**

Some goods within the product range of Würth Elektronik eiSos GmbH & Co. KG contain statements regarding general suitability for certain application areas. These statements about suitability are based on our knowledge and experience of typical requirements concerning the areas, serve as general guidance and cannot be estimated as binding statements about the suitability for a customer application. The responsibility for the applicability and use in a particular customer design is always solely within the authority of the customer. Due to this fact, it is up to the customer to evaluate, where appropriate to investigate and to decide whether the device with the specific product characteristics described in the product specification is valid and suitable for the respective customer application or not. Accordingly, the customer is cautioned to verify that the documentation is current before placing orders.

### **14.2 Customer responsibility related to specific, in particular safety-relevant applications**

It has to be clearly pointed out that the possibility of a malfunction of electronic components or failure before the end of the usual lifetime cannot be completely eliminated in the current state of the art, even if the products are operated within the range of the specifications. The same statement is valid for all software sourcecode and firmware parts contained in or used with or for products in the wireless connectivity and sensor product range of Würth Elektronik eiSos GmbH & Co. KG. In certain customer applications requiring a high level of safety and especially in customer applications in which the malfunction or failure of an electronic component could endanger human life or health, it must be ensured by most advanced technological aid of suitable design of the customer application that no injury or damage is caused to third parties in the event of malfunction or failure of an electronic component.

### **14.3 Best care and attention**

Any product-specific data sheets, manuals, application notes, PCN's, warnings and cautions must be strictly observed in the most recent versions and matching to the products firmware revisions. This documents can be downloaded from the product specific sections on the wireless connectivity homepage.

### **14.4 Customer support for product specifications**

Some products within the product range may contain substances, which are subject to restrictions in certain jurisdictions in order to serve specific technical requirements. Necessary information is available on request. In this case, the field sales engineer or the internal sales person in charge should be contacted who will be happy to support in this matter.

## 14.5 Product improvements

Due to constant product improvement, product specifications may change from time to time. As a standard reporting procedure of the Product Change Notification (PCN) according to the JEDEC-Standard, we inform about major changes. In case of further queries regarding the PCN, the field sales engineer, the internal sales person or the technical support team in charge should be contacted. The basic responsibility of the customer as per section 14.1 and 14.2 remains unaffected. All wireless connectivity module driver software "wireless connectivity SDK" and its source codes as well as all PC software tools are not subject to the Product Change Notification information process.

## 14.6 Product life cycle

Due to technical progress and economical evaluation we also reserve the right to discontinue production and delivery of products. As a standard reporting procedure of the Product Termination Notification (PTN) according to the JEDEC-Standard we will inform at an early stage about inevitable product discontinuance. According to this, we cannot ensure that all products within our product range will always be available. Therefore, it needs to be verified with the field sales engineer or the internal sales person in charge about the current product availability expectancy before or when the product for application design-in disposal is considered. The approach named above does not apply in the case of individual agreements deviating from the foregoing for customer-specific products.

## 14.7 Property rights

All the rights for contractual products produced by Würth Elektronik eiSos GmbH & Co. KG on the basis of ideas, development contracts as well as models or templates that are subject to copyright, patent or commercial protection supplied to the customer will remain with Würth Elektronik eiSos GmbH & Co. KG. Würth Elektronik eiSos GmbH & Co. KG does not warrant or represent that any license, either expressed or implied, is granted under any patent right, copyright, mask work right, or other intellectual property right relating to any combination, application, or process in which Würth Elektronik eiSos GmbH & Co. KG components or services are used.

## 14.8 General terms and conditions

Unless otherwise agreed in individual contracts, all orders are subject to the current version of the "General Terms and Conditions of Würth Elektronik eiSos Group", last version available at [www.we-online.com](http://www.we-online.com).

## **15 Legal notice**

### **15.1 Exclusion of liability**

Würth Elektronik eiSos GmbH & Co. KG considers the information in this document to be correct at the time of publication. However, Würth Elektronik eiSos GmbH & Co. KG reserves the right to modify the information such as technical specifications or functions of its products or discontinue the production of these products or the support of one of these products without any written announcement or notification to customers. The customer must make sure that the information used corresponds to the latest published information. Würth Elektronik eiSos GmbH & Co. KG does not assume any liability for the use of its products. Würth Elektronik eiSos GmbH & Co. KG does not grant licenses for its patent rights or for any other of its intellectual property rights or third-party rights.

Notwithstanding anything above, Würth Elektronik eiSos GmbH & Co. KG makes no representations and/or warranties of any kind for the provided information related to their accuracy, correctness, completeness, usage of the products and/or usability for customer applications. Information published by Würth Elektronik eiSos GmbH & Co. KG regarding third-party products or services does not constitute a license to use such products or services or a warranty or endorsement thereof.

### **15.2 Suitability in customer applications**

The customer bears the responsibility for compliance of systems or units, in which Würth Elektronik eiSos GmbH & Co. KG products are integrated, with applicable legal regulations. Customer acknowledges and agrees that it is solely responsible for compliance with all legal, regulatory and safety-related requirements concerning its products, and any use of Würth Elektronik eiSos GmbH & Co. KG components in its applications, notwithstanding any applications-related information or support that may be provided by Würth Elektronik eiSos GmbH & Co. KG. Customer represents and agrees that it has all the necessary expertise to create and implement safeguards which anticipate dangerous consequences of failures, monitor failures and their consequences lessen the likelihood of failures that might cause harm and take appropriate remedial actions. The customer will fully indemnify Würth Elektronik eiSos GmbH & Co. KG and its representatives against any damages arising out of the use of any Würth Elektronik eiSos GmbH & Co. KG components in safety-critical applications.

### **15.3 Trademarks**

AMBER wireless is a registered trademark of Würth Elektronik eiSos GmbH & Co. KG. All other trademarks, registered trademarks, and product names are the exclusive property of the respective owners.

### **15.4 Usage restriction**

Würth Elektronik eiSos GmbH & Co. KG products have been designed and developed for usage in general electronic equipment only. This product is not authorized for use in equipment

where a higher safety standard and reliability standard is especially required or where a failure of the product is reasonably expected to cause severe personal injury or death, unless the parties have executed an agreement specifically governing such use. Moreover, Würth Elektronik eiSos GmbH & Co. KG products are neither designed nor intended for use in areas such as military, aerospace, aviation, nuclear control, submarine, transportation (automotive control, train control, ship control), transportation signal, disaster prevention, medical, public information network etc. Würth Elektronik eiSos GmbH & Co. KG must be informed about the intent of such usage before the design-in stage. In addition, sufficient reliability evaluation checks for safety must be performed on every electronic component, which is used in electrical circuits that require high safety and reliability function or performance. By using Würth Elektronik eiSos GmbH & Co. KG products, the customer agrees to these terms and conditions.

## 16 License terms

These License terms will take effect upon the purchase and usage of the Würth Elektronik eiSos GmbH & Co. KG wireless connectivity products. You hereby agree that these license terms are applicable to the product and the incorporated software, firmware and source codes (collectively, "Software") made available by Würth Elektronik eiSos in any form, including but not limited to binary, executable or source code form.

The software included in any Würth Elektronik eiSos wireless connectivity product is purchased to you on the condition that you accept the terms and conditions of these license terms. You agree to comply with all provisions under these license terms.

### 16.1 Limited license

Würth Elektronik eiSos hereby grants you a limited, non-exclusive, non-transferable and royalty-free license to use the software and under the conditions that will be set forth in these license terms. You are free to use the provided software only in connection with one of the products from Würth Elektronik eiSos to the extent described in these license terms. You are entitled to change or alter the source code for the sole purpose of creating an application embedding the Würth Elektronik eiSos wireless connectivity product. The transfer of the source code to third parties is allowed to the sole extent that the source code is used by such third parties in connection with our product or another hardware provided by Würth Elektronik eiSos under strict adherence of these license terms. Würth Elektronik eiSos will not assume any liability for the usage of the incorporated software and the source code. You are not entitled to transfer the source code in any form to third parties without prior written consent of Würth Elektronik eiSos.

You are not allowed to reproduce, translate, reverse engineer, decompile, disassemble or create derivative works of the incorporated software and the source code in whole or in part. No more extensive rights to use and exploit the products are granted to you.

### 16.2 Usage and obligations

The responsibility for the applicability and use of the Würth Elektronik eiSos wireless connectivity product with the incorporated firmware in a particular customer design is always solely within the authority of the customer. Due to this fact, it is up to you to evaluate and investigate, where appropriate, and to decide whether the device with the specific product characteristics described in the product specification is valid and suitable for your respective application or not.

You are responsible for using the Würth Elektronik eiSos wireless connectivity product with the incorporated firmware in compliance with all applicable product liability and product safety laws. You acknowledge to minimize the risk of loss and harm to individuals and bear the risk for failure leading to personal injury or death due to your usage of the product.

Würth Elektronik eiSos' products with the incorporated firmware are not authorized for use in safety-critical applications, or where a failure of the product is reasonably expected to cause severe personal injury or death. Moreover, Würth Elektronik eiSos' products with the incorporated firmware are neither designed nor intended for use in areas such as military, aerospace, aviation, nuclear control, submarine, transportation (automotive control, train control, ship control), transportation signal, disaster prevention, medical, public information network etc. You

shall inform Würth Elektronik eiSos about the intent of such usage before design-in stage. In certain customer applications requiring a very high level of safety and in which the malfunction or failure of an electronic component could endanger human life or health, you must ensure to have all necessary expertise in the safety and regulatory ramifications of your applications. You acknowledge and agree that you are solely responsible for all legal, regulatory and safety-related requirements concerning your products and any use of Würth Elektronik eiSos' products with the incorporated firmware in such safety-critical applications, notwithstanding any applications-related information or support that may be provided by Würth Elektronik eiSos. YOU SHALL INDEMNIFY WÜRTH ELEKTRONIK EISOS AGAINST ANY DAMAGES ARISING OUT OF THE USE OF WÜRTH ELEKTRONIK EISOS' PRODUCTS WITH THE INCORPORATED FIRMWARE IN SUCH SAFETY-CRITICAL APPLICATIONS.

### **16.3 Ownership**

The incorporated firmware created by Würth Elektronik eiSos is and will remain the exclusive property of Würth Elektronik eiSos.

### **16.4 Firmware update(s)**

You have the opportunity to request the current and actual firmware for a bought wireless connectivity product within the time of warranty. However, Würth Elektronik eiSos has no obligation to update a modules firmware in their production facilities, but can offer this as a service on request. The upload of firmware updates falls within your responsibility, e.g. via ACC or another software for firmware updates. Firmware updates will not be communicated automatically. It is within your responsibility to check the current version of a firmware in the latest version of the product manual on our website. The revision table in the product manual provides all necessary information about firmware updates. There is no right to be provided with binary files, so called "firmware images", those could be flashed through JTAG, SWD, Spi-Bi-Wire, SPI or similar interfaces.

### **16.5 Disclaimer of warranty**

THE FIRMWARE IS PROVIDED "AS IS". YOU ACKNOWLEDGE THAT WÜRTH ELEKTRONIK EISOS MAKES NO REPRESENTATIONS AND WARRANTIES OF ANY KIND RELATED TO, BUT NOT LIMITED TO THE NON-INFRINGEMENT OF THIRD PARTIES' INTELLECTUAL PROPERTY RIGHTS OR THE MERCHANTABILITY OR FITNESS FOR YOUR INTENDED PURPOSE OR USAGE. WÜRTH ELEKTRONIK EISOS DOES NOT WARRANT OR REPRESENT THAT ANY LICENSE, EITHER EXPRESS OR IMPLIED, IS GRANTED UNDER ANY PATENT RIGHT, COPYRIGHT, MASK WORK RIGHT, OR OTHER INTELLECTUAL PROPERTY RIGHT RELATING TO ANY COMBINATION, MACHINE, OR PROCESS IN WHICH THE WÜRTH ELEKTRONIK EISOS' PRODUCT WITH THE INCORPORATED FIRMWARE IS USED. INFORMATION PUBLISHED BY WÜRTH ELEKTRONIK EISOS REGARDING THIRD-PARTY PRODUCTS OR SERVICES DOES NOT CONSTITUTE A LICENSE FROM WÜRTH ELEKTRONIK EISOS TO USE SUCH PRODUCTS OR SERVICES OR A WARRANTY OR ENDORSEMENT THEREOF.



## **16.6 Limitation of liability**

Any liability not expressly provided by Würth Elektronik eiSos shall be disclaimed. You agree to hold us harmless from any third-party claims related to your usage of the Würth Elektronik eiSos' products with the incorporated firmware, software and source code. Würth Elektronik eiSos disclaims any liability for any alteration, development created by you or your customers as well as for any combination with other products.

## **16.7 Applicable law and jurisdiction**

Applicable law to these license terms shall be the laws of the Federal Republic of Germany. Any dispute, claim or controversy arising out of or relating to these license terms shall be resolved and finally settled by the court competent for the location of Würth Elektronik eiSos registered office.

## **16.8 Severability clause**

If a provision of these license terms is or becomes invalid, unenforceable or null and void, this shall not affect the remaining provisions of the terms. The parties shall replace any such provisions with new valid provisions that most closely approximate the purpose of the terms.

## **16.9 Miscellaneous**

Würth Elektronik eiSos reserves the right at any time to change this terms at its own discretion. It is your responsibility to check at Würth Elektronik eiSos homepage for any updates. Your continued usage of the products will be deemed as the acceptance of the change.

We recommend you to be updated about the status of new firmware and software, which is available on our website or in our data sheet and manual, and to implement new software in your device where appropriate.

By ordering a product, you accept these license terms in all terms.

## List of Figures

1	Adrastea-I . . . . .	8
2	Adrastea-I GCF Certification . . . . .	9
3	Adrastea-I Deutsche Telekom Certification . . . . .	10
4	Normal Cellular Certification Process . . . . .	11
5	Benefits of Deutsche Telekom Certified Module . . . . .	12
6	Block diagram . . . . .	15
7	Pinout (top view) . . . . .	23
8	Adrastea-I Power up Sequence . . . . .	29
9	UART0 Host Interface . . . . .	38
10	SPIM Connection . . . . .	40
11	I <sup>2</sup> C Connection . . . . .	42
12	Adrastea-I State Transition . . . . .	47
13	Adrastea-I: Sony MCU portal registration . . . . .	51
14	Adrastea-I: Sony MCU portal Access . . . . .	52
15	Minimal pin connections . . . . .	53
16	Adrastea Commander . . . . .	55
17	Adrastea Commander . . . . .	55
18	COM ports detected - Adrastea commander . . . . .	56
19	MiniConsole start view - Adrastea Commander . . . . .	57
20	SIM card detected - Adrastea Commander . . . . .	58
21	Layout . . . . .	65
22	Dimensioning the antenna feed line as micro strip . . . . .	66
23	Circuit diagram 1 . . . . .	69
24	Circuit diagram 2 . . . . .	70
25	Circuit diagram 3 . . . . .	71
26	Circuit diagram 4 . . . . .	72
27	Circuit diagram 5 . . . . .	73
28	Assembly diagram . . . . .	74
29	Top layer (upper left), second layer (upper right), third layer (bottom left), fourth layer (bottom right) . . . . .	75
30	Reflow soldering profile . . . . .	77
31	Module dimensions [mm] . . . . .	82
32	Footprint and dimensions [mm] . . . . .	83
33	Lot number structure . . . . .	84
34	Label of the Adrastea-I . . . . .	85

## List of Tables

1	Module Key Features . . . . .	14
2	Ordering information . . . . .	15
3	Recommended operating conditions . . . . .	16
4	LTE-Cat.M Current consumption . . . . .	16
5	NB-IoT Current consumption . . . . .	17
6	LTE-Cat.M Supported Bands . . . . .	18
7	LTE-Cat.NB-IoT Supported Bands . . . . .	18

8	LTE-Cat.M RX Sensitivity . . . . .	19
9	LTE-Cat.NB-IoT RX Sensitivity . . . . .	19
10	LTE-Cat.M Maximum Output Power . . . . .	20
11	LTE-Cat.NB-IoT Maximum Output Power . . . . .	20
12	Radio characteristics . . . . .	21
13	GNSS RX Sensitivity . . . . .	22
14	GNSS Time to First Fix . . . . .	22
15	GNSS Position Accuracy . . . . .	22
16	Pinout . . . . .	24
17	Pinout1 . . . . .	25
18	Pinout2 . . . . .	26
19	Pinout3 . . . . .	27
20	Pinout4 . . . . .	28
21	Power Up timing . . . . .	28
22	EXT_ALARM Pin . . . . .	31
23	E-JTAG Debug port . . . . .	33
24	GPIO Pin Information . . . . .	34
25	Digital IO Pins Specifications . . . . .	34
26	UART Interfaces . . . . .	35
27	UART Default Configuration . . . . .	35
28	UART0 Pin Interface . . . . .	36
29	UART1 Pin Interface . . . . .	36
30	UART2 Pin Interface . . . . .	37
31	SPIM Pin Interface . . . . .	39
32	I <sup>2</sup> C Pin Interface . . . . .	41
33	ADC Interfaces . . . . .	43
34	ADC Functional Specifications . . . . .	43
35	Measured Input Resistance . . . . .	44
36	ADC Pin Interface . . . . .	44
37	SIM Pin Interface . . . . .	44
38	RF Pin Interface . . . . .	45
39	E-JTAG Debug port . . . . .	45
40	GPIO Pin Information . . . . .	46
41	Classification reflow soldering profile, Note: refer to IPC/JEDEC J-STD-020E . .	76
42	Package classification reflow temperature, PB-free assembly, Note: refer to IPC/- JEDEC J-STD-020E . . . . .	77
43	Dimensions . . . . .	81
44	Weight . . . . .	81
45	Lot number details . . . . .	84



**Contact**

Würth Elektronik eiSos GmbH & Co. KG  
Division Wireless Connectivity & Sensors

Max-Eyth-Straße 1  
74638 Waldenburg  
Germany

Tel.: +49 651 99355-0  
Fax.: +49 651 99355-69  
[www.we-online.com/wireless-connectivity](http://www.we-online.com/wireless-connectivity)

**WÜRTH ELEKTRONIK** MORE THAN YOU EXPECT