

Description

- Standard 2 x 1.6mm crystal oscillator in a hermetically sealed ceramic package with a seam sealed metal lid
- Model IQXO-542
- Model Issue number 7

Frequency Parameters

- Frequency 24.0MHz
- Frequency Stability $\pm 50.00\text{ppm}$
- Operating Temperature Range -40.00 to 85.00°C
- Ageing $\pm 5\text{ppm}$ per year

Electrical Parameters

- Supply Voltage $1.8\text{V} \pm 10\%$
- Current Draw 15.000mA max

Output Details

- Output Compatibility CMOS
- Drive Capability 15pF max
- Rise and Fall Time 7.0ns max
- Duty Cycle $40/60$ max
- Start up Time:
1.1ms typ to 90% of final amplitude (under ideal conditions @ 25°C)
10ms max

Output Control

- Standby Operation:
Logic '1' ($\geq 70\%V_s$) to pad 1 enables oscillator output
Logic '0' ($\leq 30\%V_s$) to pad 1 disables oscillator output; when disabled the oscillator output goes to the high impedance state
No connection to pad 1 enables oscillator output
- Standby Current:
 $0.6\mu\text{A}$ typ @ 25°C
 $10\mu\text{A}$ max

Output Levels

- Output High (VoH): 90% of V_s min
Output Low (VoL): 10% of V_s max

Environmental Parameters

- Storage Temperature Range: -55 to 125°C
- Shock: Half sine shock pulse with peak acceleration 500g ;
Pulse duration: 0.3ms
- Vibration: MIL-STD-202 Method 204. 5g for 20 minutes, 12 cycles in each of the 3 orientations, $10 \sim 2000$ Hz. As per Table 11 of AEC-Q200.

Manufacturing Details

- RoHS Terminations Ni, Au & TI
- RoHS Reflow Temp 260°C max for 10 seconds

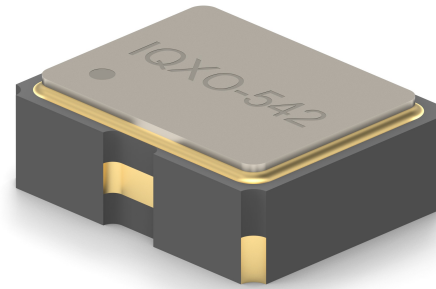

Outline (mm)

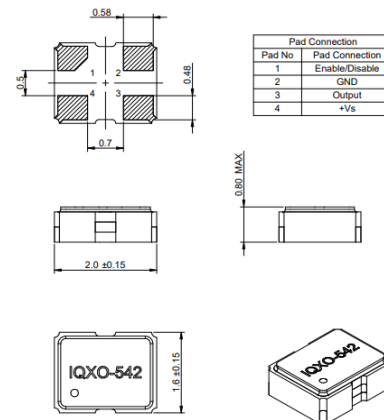

Recommended Solder Pad Layout

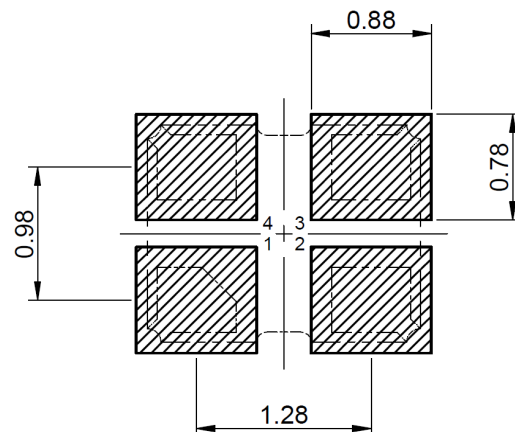

CONTACT INFORMATION:

Würth Elektronik eiSos GmbH & Co. KG
Max-Eyth-Str. 1, 74638 Waldenburg, Germany
Tel: +49(0) 7942 945-0

Email: eiSos@we-online.de
Web: www.we-online.com

Compliance

- RoHS Status (2015/863/EU) Compliant
- REACH Status Compliant
- MSL Rating (JDEC-STD-033): Not Applicable

Packaging Details

- Tape & reel in accordance with EIA-481
Quantities below the standard reel size to
be supplied on cut tape.
Standard Quantity: 3,000 Pieces

USEFUL LINKS

Toolbox:

www.we-online.com/toolbox

Product Catalog:

www.we-online.com/products

Test Circuit

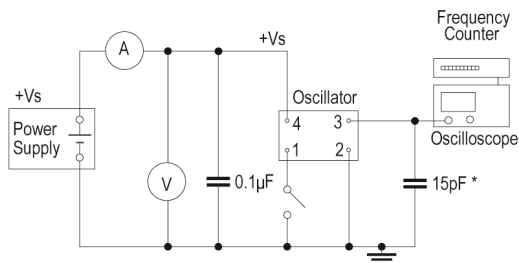

* Inclusive of jigging and equipment capacitance

Waveform

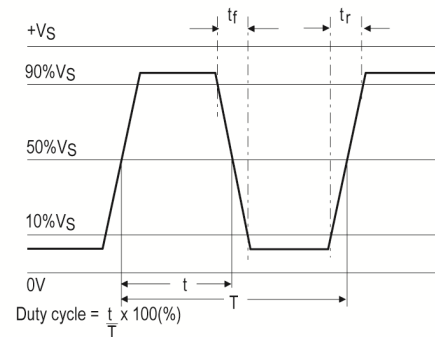

CONTACT INFORMATION:

Würth Elektronik eiSos GmbH & Co. KG
Max-Eyth-Str. 1, 74638 Waldenburg, Germany
Tel: +49(0) 7942 945-0

Email: eiSos@we-online.de
Web: www.we-online.com