

Description

- Standard 2.5 x 2.0 oscillator in a ceramic package with a hermetically sealed metal lid.
- Model IQXO-794
- Model Issue number 4

Frequency Parameters

- Frequency 8.0MHz
- Frequency Stability $\pm 25.00\text{ppm}$
- Operating Temperature Range -20.00 to 70.00°C
- Ageing $\pm 5\text{ppm}$ per year

Electrical Parameters

- Supply Voltage $1.8\text{V} \pm 10\%$
- Current Draw 10.000mA max

Output Details

- Output Compatibility CMOS
- Drive Capability 15pF max
- Rise and Fall Time 7.0ns max
- Duty Cycle $40/60$ max
- Start Up Time:
 0.9ms typ to 90% of final amplitude (under ideal conditions @ 25°C)
 10ms max
- Output Voltage Levels:
Output Low (VoL): 10% Vs max
Output High (VoH): 90% Vs min

Output Control

- Enable/Disable:
Logic '1' ($\geq 70\%$ Vs) to pad 1 enables oscillator output.
Logic '0' ($\leq 30\%$ Vs) to pad 1 disables oscillator output. When disabled the oscillator output goes to the high impedance state.
No connection to pad 1 enables oscillator output.
- Standby Current:
 $0.5\mu\text{A}$ typ @ 25°C
 $10\mu\text{A}$ max

Noise Parameters

- Period Jitter (pk-pk): $\pm 80\text{ps}$ typ
- Period Jitter (1σ): $\pm 10\text{ps}$ typ
- RMS Phase Jitter (12kHz to 20MHz): 1ps max

Environmental Parameters

- Storage Temperature Range: -55 to 125°C
- Shock: Half Sine shock pulse with peak acceleration 500g ; Pulse duration: 0.3ms
- Vibration: MIL-STD-202 Method 204. 5g for 20 minutes, 12 cycles in each of the 3 orientations, $10 \sim 2000$ Hz. As per Table 11 of AEC-Q200.

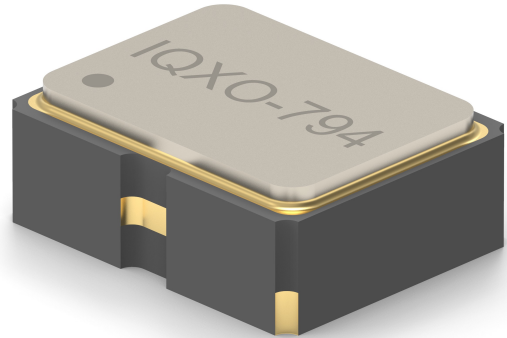

Outline (mm)

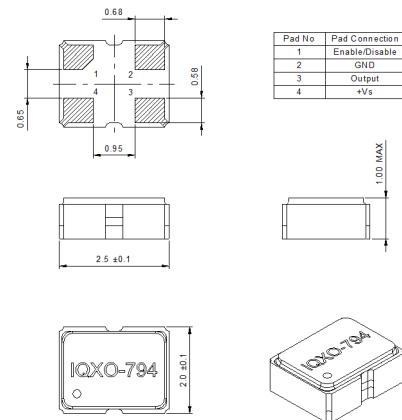

Recommended Solder Pad Layout

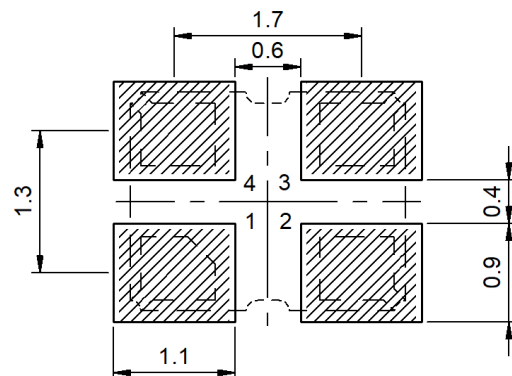

CONTACT INFORMATION:

Würth Elektronik eiSos GmbH & Co. KG
Max-Eyth-Str. 1, 74638 Waldenburg, Germany
Tel: +49(0) 7942 945-0

Email: eiSos@we-online.de
Web: www.we-online.com

Manufacturing Details

- RoHS Terminations NiAu
- RoHS Reflow Temp 260°C max for 10 seconds max

Compliance

- RoHS Status (2015/863/EU) Compliant
- REACH Status Compliant
- MSL Rating (JDEC-STD-033): Not Applicable

Packaging Details

- Tape & reel in accordance with EIA-481
Quantities below the standard reel size to
be supplied on cut tape.
Standard Quantity: 3,000 Pieces
-

USEFUL LINKS

Toolbox:

www.we-online.com/toolbox

Product Catalog:

www.we-online.com/products

CONTACT INFORMATION:

Würth Elektronik eiSos GmbH & Co. KG
Max-Eyth-Str. 1, 74638 Waldenburg, Germany
Tel: +49(0) 7942 945-0

Email: eiSos@we-online.de
Web: www.we-online.com