

APPLICATION NOTE

Input Filter for Mag1³C Power Modules



ANS004 BY RANJITH BRAMANPALLI AND STEFFEN SCHULZE

1. Requirement for an input filter

Independent of their individual topology and application, due to AC components in their lines switching controllers create conducted EMC interferences. Würth Elektronik Mag1³C power modules are optimized for a low line-bound and radiated emission of interferences. Their residual ripple generally exhibits a negligibly low value, meaning that an output filter can be dispensed with in most applications. Since the input current at the step-down converter is pulsating, this may generate radio-frequency interferences in the application. Depending on the specific application, the hardware developer decides whether an input filter is necessary directly before the power module or in another position in the switch. This general Application Note describes the design process of input filters for Würth Elektronik Mag1³C power modules and the measurement techniques that are used.

2. How differential mode noises develop

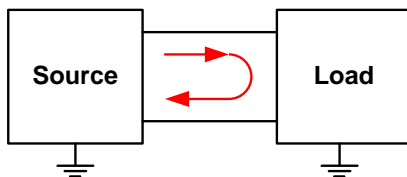

Figure 1: Symmetrical system

Differential mode noises are interference signals in a system with a symmetrical current back and forth between the source and the load in the lines of a switching controller.

In the input circuit, the clock frequency of the power module includes an AC component superimposed over the useful current and is similar in its configuration to the current through the storage inductance of the power module. The input current flows into the input capacitor C_{in} . Real capacitors possess a resistive component, the ESR, and an inductive component, the ESL. This is shown in Figure 2.

Due to the ESR of the input capacitor and the impedances of the lines of the power module, the AC component produces an undesirable voltage drop.

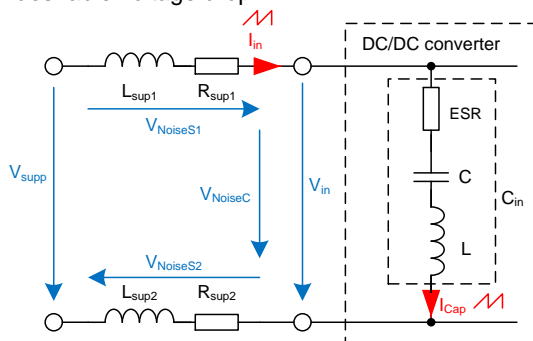

Figure 2: Development of the noise voltage

In this form, the noise voltage shows up as a differential-mode signal. The amplitude of the interference voltage occurring at the input capacitor is essentially dependent on the ESR of the capacitor used. Electrolytic capacitors have a relatively high ESR, the value of which can range between just a few milliohms up to several ohms. As a consequence, the interference voltage can vary between a few millivolts up to several volts. Ceramic capacitors, on the other hand, have a very small ESR of just a few milliohms and thus result in a noise voltage of a few millivolts. In addition, the circuit-board design of the power module exerts a great effect on the interference voltage (cf. the Application Note: "[Quiet switching controller for audio amplifiers](#)").

3. Calculating an LC input filter

To reduce differential mode noises, at least one simple LC filter must be fitted at the input of the converter as a measure to minimize the AC component in the line. In high-impedance systems, such an input filter can theoretically produce a voltage attenuation of 40 dB/decade in the stopband. In practice, a lower degree of attenuation is achieved since the terminating impedances are low-ohm in their nature and also because the components themselves exhibit losses. In dimensioning the LC filter a corner frequency f_c is selected that is below the switching frequency f_{sw} of the power module. If the factor is one tenth, theoretically an insertion loss of 40 dB is achieved at the switching frequency at which the highest spectral amplitude occurs.

$$f_c = \frac{f_{sw}}{10} \quad (1)$$

The corner frequency of an LC filter is generally:

$$f_c = \frac{1}{2\pi \cdot \sqrt{L_f \cdot C_f}} \quad (2)$$

As an example for the calculation of the filter, an inductance of 10 μ H is selected and equation (2) is transformed to

$$C_f = \frac{1}{(2\pi \cdot 0.1 \cdot f_{sw})^2 \cdot L_f} \quad (3)$$

In arranging the filter components, as shown in Figure 3 the filter capacitor can be positioned on the side of the voltage source or on the input side of the power module. The decisive factor for the attenuation of the pulsating current drawn from the voltage source is the inductance of the filter inductor.

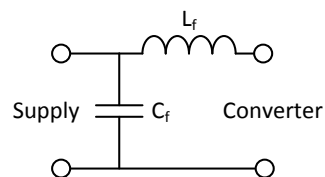

Figure 3: Arrangement of the components of the input filter

APPLICATION NOTE

Input Filter for Mag³C Power Modules



4. Attenuation of the input filter

When the quality of the filter resonance is too high, oscillations may occur in the event of changes in the input voltage that must be regulated. The stability criterion that applies here is that the output impedance of the input filter $Z_{out,filter}$ within a broad frequency spectrum has to be lower than the input impedance of the power module $Z_{in,converter}$.

$$|Z_{out,filter}| < |Z_{in,converter}| \quad (4)$$

In addition, the corner frequency f_c of the input filter should lie far below the crossover frequency f_{co} of the power module.

$$f_{c,filter} \ll f_{co,converter} \quad (5)$$

Figure 4 shows how this is done by placing an attenuating branch parallel to the power module input.

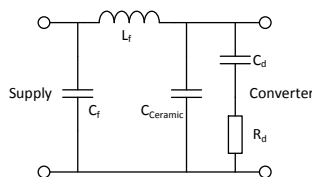

Figure 4: Attenuation of the input filter

The attenuator reduces the quality of the input filter and consequently its output impedance at the resonance frequency. Equation (6) can be applied to calculate the attenuation resistance R_d for a filter quality of $Q_f=1$:

$$R_d = \sqrt{\frac{L_f}{C_f}} \quad (6)$$

A value that has established itself in practice as an indicator of the capacity of the attenuation capacitor C_d is the five-to-ten-fold measure of the filter-capacitor capacitance.

$$(5 \cdot C_f) < C_d < (10 \cdot C_f) \quad (7)$$

As an alternative, the filter can be attenuated by selecting an electrolytic capacitor that is switched parallel to the filter output instead of the attenuator. As a rule, the value of the ESR of the electrolyte capacitor is sufficient to attenuate the filter.

5. Selecting the LC filter components

Both capacitors and coils show capacitive as well as inductive properties in reality. Filter inductors have their highest filter effect at their self-resonant frequency (SRF). In coils, the SRF is strongly dependent on the inductance and the capacitive coupling between the winding turns. In capacitors, the SRF is strongly dependent on the capacitance and the length of their terminations. When selecting the filter components, it is hence advisable to make sure that the SRF is at the upper

end of the frequency range in which the RFI voltage is at its maximum or, respectively, in which the filter is to be active.

The decisive factor for the reduction of the differential-mode noise is the filter inductor, since this is the component that counteracts the rapid rise and drop in the current in the input circuit. Figure 5 shows the impedance curves of three rod core chokes of the WE-SD product family.

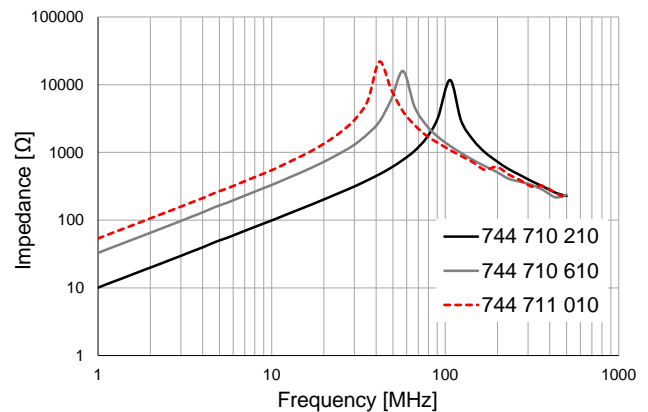

Figure 5: Impedance of WE-SD rod core chokes

The higher the inductance, the smaller the SRF. It is recommended to select an inductor with an inductance whose numeric value is lower than the capacitance of the filter capacitor. In practice, a filter inductance with a maximum value of 10 μ H is selected, since – depending on the design – such an inductance has a self-resonant frequency of approximately 30 MHz.

Exceeding the rated current of the filter inductor may result in damage to the wire winding. Taking the efficiency of the switching controller as a basis, it is possible to calculate the effective input current of the power module using equation (8).

$$I_{in} = \frac{V_{out} \cdot I_{out}}{V_{in} \cdot \eta} \quad (8)$$

For safety reasons, a larger value should be selected as the rated current of the filter coil.

The filter capacitor may take the form of a liquid electrolyte capacitor, a polymer capacitor, or even a ceramic capacitor. The only aspect that must be considered is that the filter quality at the corner frequency is sufficiently low (see Section 4).

6. Dimensioning a Π filter

In the optimal case, an input filter should be placed as close as possible to the input of the power module. For the case that the input filter is placed further away due to geometric circumstances, the traces may act as an antenna between the input filter and the power module at higher frequencies.

APPLICATION NOTE

Input Filter for MagI³C Power Modules



The trace inductance can, however, also be used together with a ceramic capacitor to establish an additional LC filter with a higher cut-off frequency (see Figure 6). Due to its negligibly low ESR, a ceramic capacitor can swiftly short-circuit high-frequency voltages to ground with low impedance.

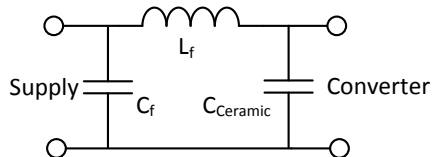

Figure 6: Π input filter

The SRF of the capacitor should roughly lie within the spectrum of the switching frequency of the power module. Figure 7 shows impedance curves of Würth Elektronik [WCAP-CSGP](#) ceramic capacitors in the 0805 size.

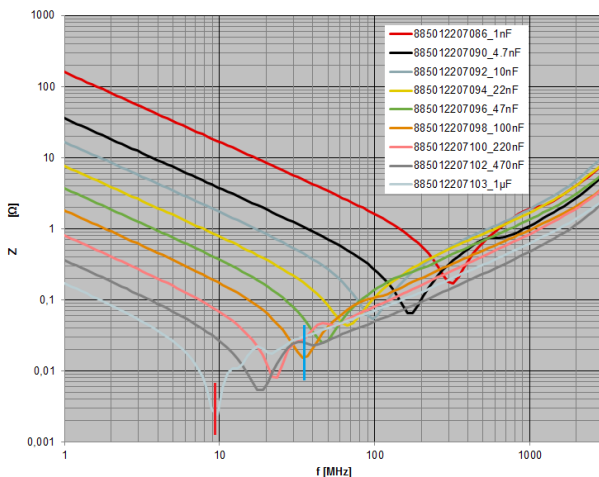

Figure 7: Impedance of ceramic capacitors

Of the components shown in Figure 7, at a clock frequency of 2 MHz, for example, a Würth Elektronik eiCap [885 012 207 103](#) capacitor with 1 μF would be suitable (resonant frequency marked in red). Even a Würth Elektronik eiCap [885 012 207 094](#) with 100 nF ceramic capacitor (resonant frequency marked in blue), which is used as a blocking capacitor in numerous electronic circuits, would be a suitable candidate at these values; it should be mentioned, however, that compared with the 1 μF version the 100 nF capacitor has an ESR higher by a factor of nine.

7. Dimensioning an output filter

Würth Elektronik MagI³C power modules exhibit a negligibly low residual ripple at the output, which is why an output filter is not absolutely necessary. For the case that components supplied by the switching controller decouple interference signals via interfaces (e.g. sensor switches, analog switching

circuits), it may be necessary to include an output filter to filter the output voltage.

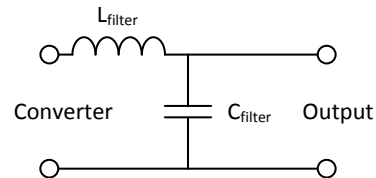

Figure 8: Output filter

The circuit schematic shown in Figure 6 images an output filter as an option comparable to that shown here in Figure 8. It is not generally possible to make a definitive statement on the necessity for and effectiveness of such an output filter, since this must be dimensioned individually for each specific application. It may be possible to use an output filter to reduce the residual ripple of the power module to an absolute minimum, or otherwise to suppress undesirable subharmonic oscillations. The filter can be dimensioned as already described above in Section 3. Attenuation of the filter resonance is not necessary in this case. Additional tips on how to dimension an output filter are given in the Application Note "[Loss-free filtered](#)".

8. Measuring the noise voltage

The noise voltage is measured according to the basic standard IEC CISPR 16-2-1, which describes the types of the interference variables to be measured, the equipment to be used for the various interfaces, and the measurement set-up for table-top and floor-standing devices. The interferences are evaluated in the frequency range from 9 kHz to 30 MHz. The measuring devices include besides the EMI receiver a variety of line impedance stabilizing networks (LISNs), voltage probes, current clamps and capacitive couplers. In a measurement set-up for table-top devices, as shown in Figure 9, the test object (DUT, "device under test") is positioned on a non-conductive table standing on a ground reference plane. The table should be 40 cm in height. In the case that a vertical ground reference plane is also present, the table should be at least 80 cm in height. The LISN must be connected to the ground plane ensuring good conductivity. The DUT itself and any attached cables are to be arranged so that they are 40 cm distant from the ground plane.

APPLICATION NOTE

Input Filter for Mag³C Power Modules

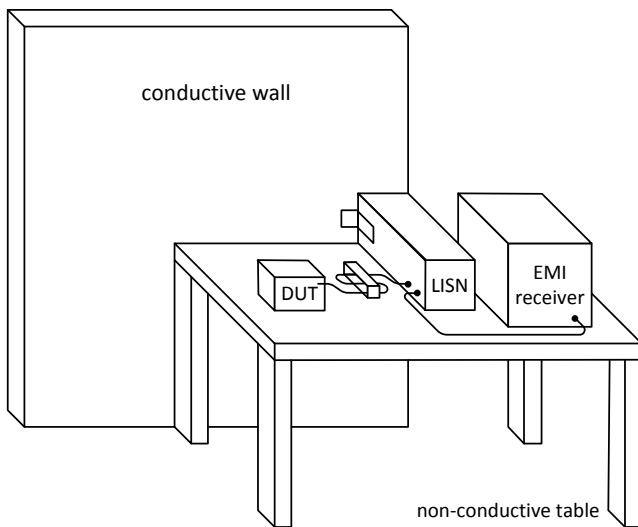

Figure 9: Test set-up for measuring conducted interferences on power-supply lines

The length of the cable between the DUT and the LISN should not exceed 80 cm. The EMI receiver evaluates the asymmetric noise voltage that is decoupled at the LISN for the separate leads of the cable.

9. Measuring the radiated noise

The method for measuring the radiated noise above 30 MHz is described in the IEC CISPR16-2-3 basic standard. The measurement environment is generally in the form of an anechoic room with a conductive floor or, at a smaller scale, an anechoic chamber. Here, too, the DUT is positioned on a non-conductive table (for portable or table-top devices, see Figure 10) or on the floor. To enable the DUT to revolve on its own axis in its default state during the measurement, it is placed on a turntable. In larger anechoic rooms, the receiving antenna is placed at a distance of 10 m from the DUT and adjusted in its height during the measurement to find the maximum electric field strength at each measurement frequency (peak spectrum). In addition, the orientation of the antenna is altered (horizontal and vertical polarization). In smaller anechoic chambers, the distance between antenna and DUT should be 3 m; since the antenna height needs to be fixed, the height scan is omitted and the floor between the antenna and the DUT must be covered with absorbing material.

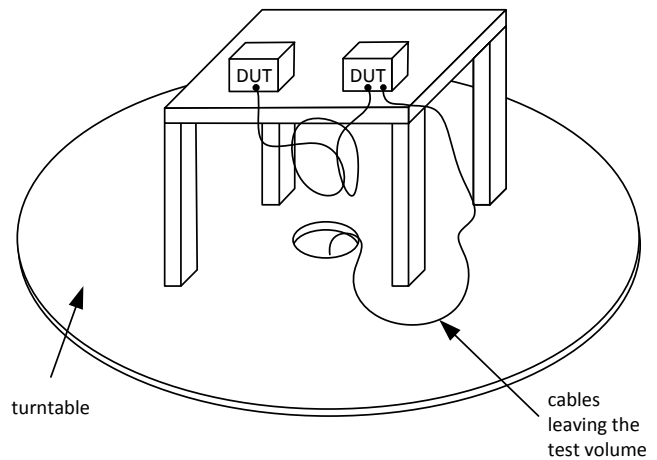

Figure 10: Test set-up for measuring the radiated noise in anechoic rooms or chambers

10. Measured noise voltage

The following section describes the measurement of the noise voltage using a Würth Elektronik Mag³C power module evaluation board fitted with the [171 020 601](#) power module as an example.

Already during the preliminary phase it is possible to measure the AC component at the power module's input using an oscilloscope. By running an analysis within the time domain, the anticipated interference spectrum can be estimated at the start of the work on the design of the filter.

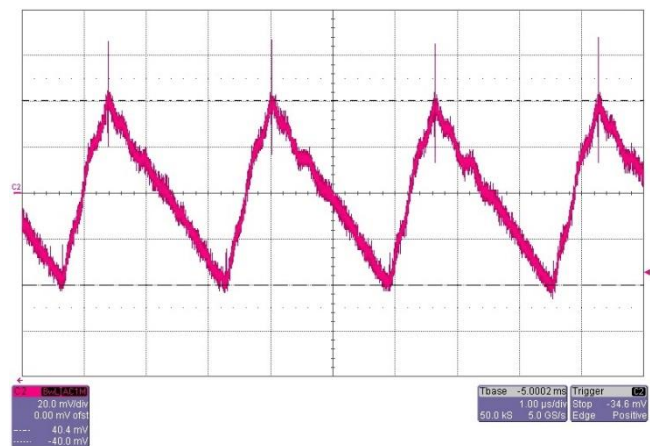

Figure 11: Time-domain signal with a broadband spectral content

APPLICATION NOTE

Input Filter for Mag1³C Power Modules



Figure 11 shows an AC component of 80 mV, measured at an input voltage of the power module of 7.5 V, an average input current of 1.2 A, and an average load current of 2 A. Switching controllers have the property to show up as a negative differential resistance from the viewpoint of the power supply (see Application Note: “[Negative input resistance of switching regulators](#)”). The input current rises with decreasing input

$$C_f = \frac{1}{(2\pi \cdot 0.1 \cdot 270 \text{ kHz})^2 \cdot 4.7 \mu\text{H}} = 7.4 \mu\text{F} \quad (9)$$

The selected filter capacitor is the one with the next highest capacitance of 10 μF , the Würth Elektronik eiCap [WCAP-ASLL](#) series, [865 060 542 002](#). The maximum input current is calculated using equation (8) from Section 3.

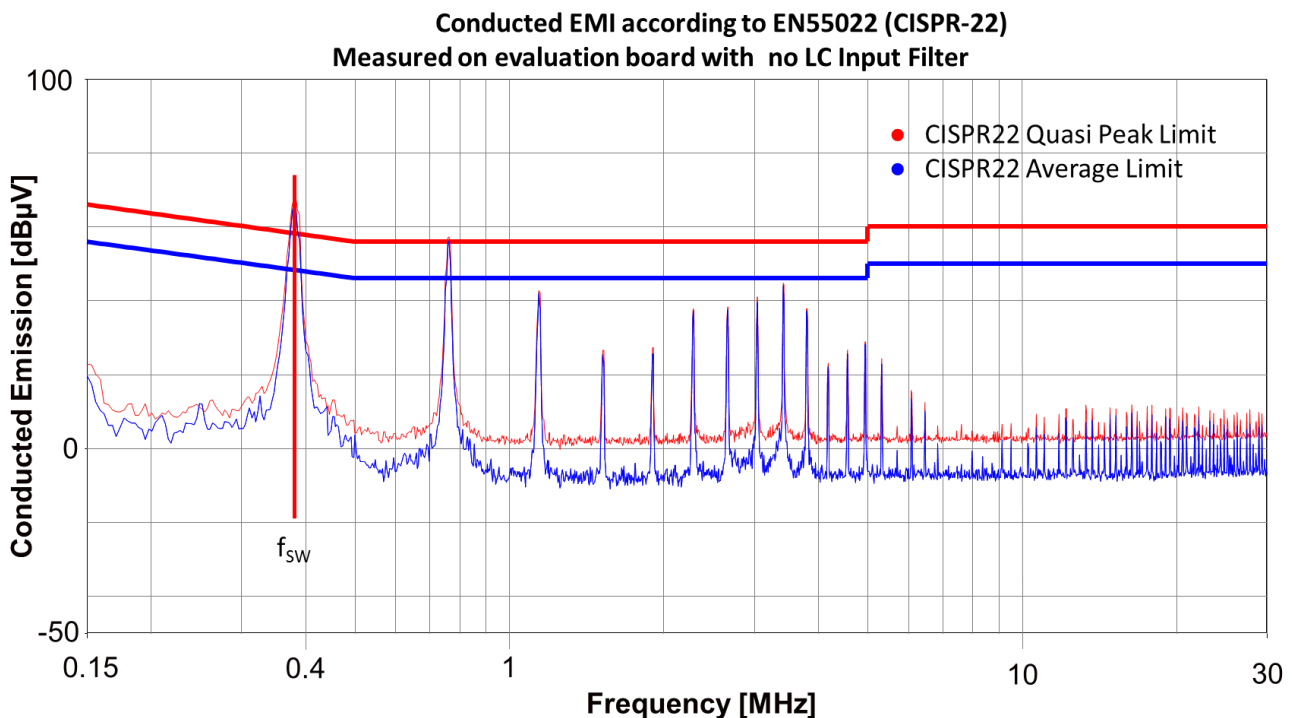

Figure 12: Noise voltage without an input filter

voltage. For this reason, the noise voltage is measured under “worst case” conditions – minimum input voltage, maximum current.

The decisive factor in the analysis of this type of noise emission, however, remains the measurement of noise voltage as can be performed in an EMC laboratory. Figure 12 shows the result of a noise voltage measurement without an input filter.

This power module operates at a clock frequency of 370 kHz. In the interference spectrum, the highest amplitude (red peak: 68 dB μV) can be measured at this frequency. The amplitude density of the noise voltage drops at a rate of approx. 40 dB/decade, meaning that no significant interference level can be seen above the 15th harmonic. Nevertheless, it is only above the 9th harmonic that the interference level is more than 10 dB below the limit for the average detector (dark blue line).

Equation (3) from Section 3 can now be used to calculate a suitable LC input filter. Due to the relatively low switching frequency, an inductor with a low SRF and an inductance of 4.7 μH is selected and the filter capacitance is calculated.

This calculation requires the efficiency of the evaluation board, which is determined by measurement and in this case has a value of 91%.

$$I_{in} = \frac{5 \text{ V} \cdot 2 \text{ A}}{6 \text{ V} \cdot 0.91} = 1.83 \text{ A}$$

On the basis of the calculations of the filter inductance and input current, it is now possible to select an appropriate inductor. Picked for the purpose is an unshielded inductor of the Würth Elektronik PD2 series, size 5820, with the [744 774 50 47](#). Figure 13 shows the result of the noise voltage measurement with the matched filter.

APPLICATION NOTE

Input Filter for Mag1³C Power Modules



Conducted EMI according to EN55022 (CISPR-22)
Measured on evaluation board with 4.7µH+10µF LC Input Filter

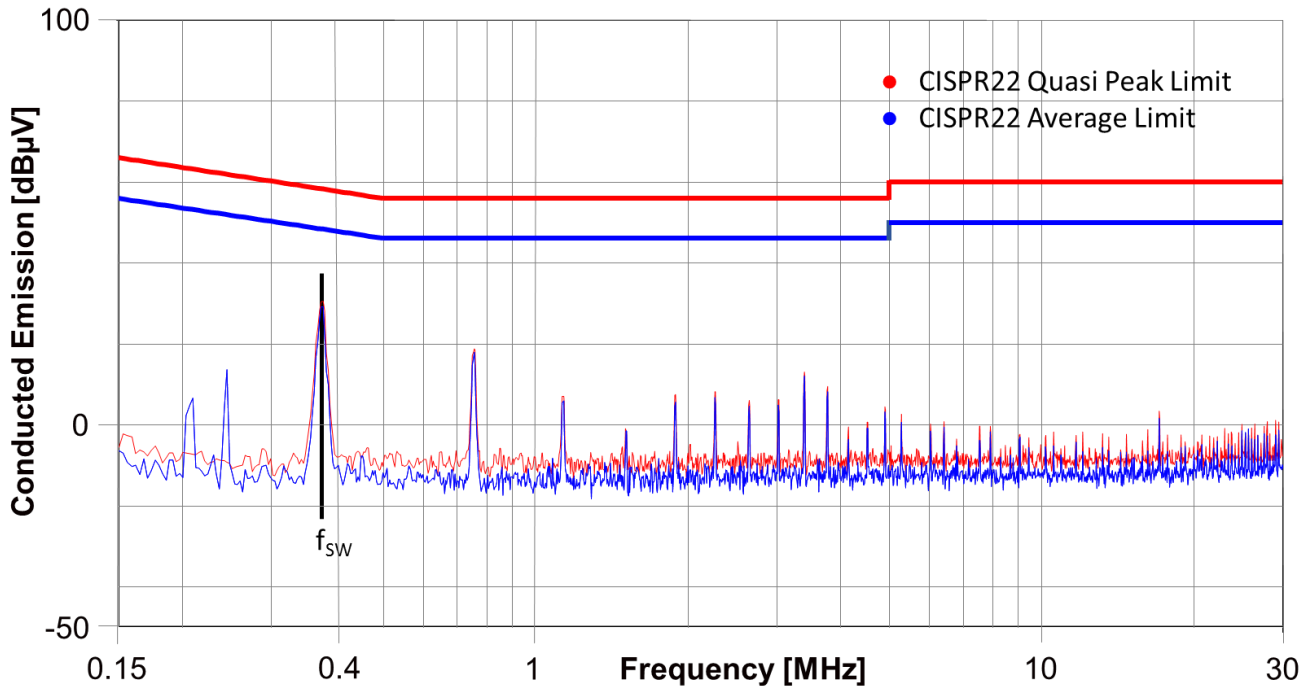

Figure 13: Noise voltage with an input filter

The interference level measured at the 370 kHz switching frequency has a value of 30 dBµV. The levels of all harmonics are lower than 20 dBµV and are thus sufficiently attenuated. The average level at 370 kHz corresponds to the peak level and is 18 dB lower than the average limit of 47 dBµV. In measuring such conducted interferences in the practical context, a signal-to-noise ratio of this dimension is entirely sufficient in order to confirm the conformity of this measurement.

The purpose of the measurement of the noise voltage is to demonstrate the usefulness of an analysis of the interference potential in the time domain; though an analysis in the frequency domain is still indispensable.

Finally, the equations from Section 3 can be used to calculate an attenuating resistance.

$$R_d = \sqrt{\frac{4.7 \mu\text{H}}{10 \mu\text{F}}} = 0.686 \Omega$$

The higher the value of the attenuation resistance, the higher the attenuation of the filter resonance. In this case, the next higher resistance of the E12 series of 1 Ω can be selected.

A value of 47 µF is selected for the attenuation capacitor. This may be, for example, a Würth Elektronik eiCap ceramic capacitor of the [WCAP-CSGP](#) series, part number [885 012 108 004](#).

11. IEC CISPR 22

The above measurements were performed according to the IEC CISPR16-2-1 standard, as described in Section 8. The use of a LISN enabled the asymmetric voltage to be decoupled and equated to the asymmetric (common-mode) voltage, which was then compared to the limit, taken from the IEC CISPR 22 standard for devices for private and commercial use (Class B). For power-supply components – and this includes all types of switching controllers – there is no directly applicable EMC standard. The entire application in which the switching controller is used must be assigned to a specific category of devices and then tested according to the corresponding standard applicable for the product or product family. In this case, the product-family standard IEC CISPR 22 for IT installations was taken only with reference to the limits, which are also given in the IEC 61000-6-3 generic standard. The generic standards can be used in cases for which there is no specific standard for the device in question.

APPLICATION NOTE

Input Filter for MagI³C Power Modules



12. Summary

Irrespective of the size of the AC component involved, an input filter is today as ever a requisite factor for a successful EMC validation of a switching controller. Simple-to-apply equations can be used to calculate such an input filter on an individual basis. Taking the impedances of the filter and the switching controller into account in the equations, this enables oscillations to be avoided and also ensures the control stability of the switching controller itself. A targeted selection of the filter components lays the foundations for an optimal design of the filter. Equipped with an appropriate degree of technical skill in EMC testing methods, the hardware developer can design his switch purposefully and, wherever necessary, make any adjustments to the filter himself.

13. Layout

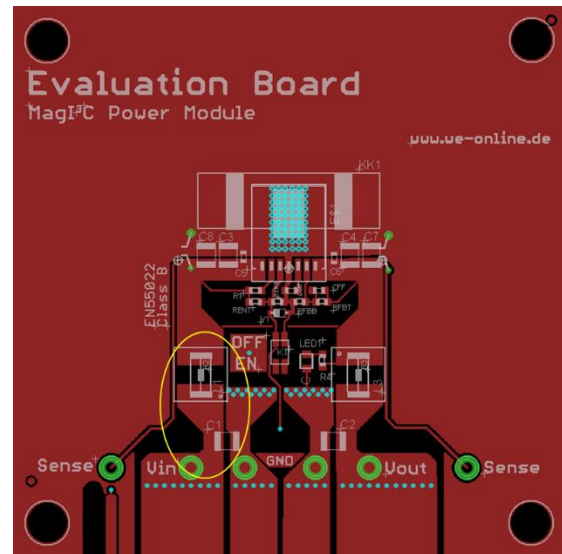

Figure 15: Input filter

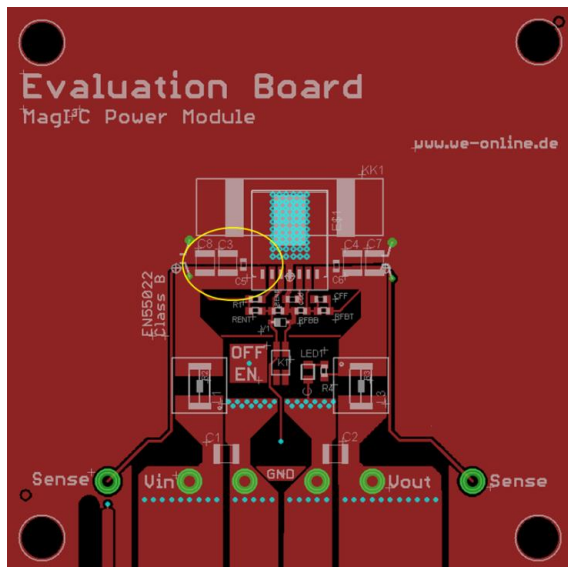

Figure 14: Positioning of the input capacitor

APPLICATION NOTE

Input Filter for Mag³C Power Modules



14. Components used in the Application Note

Index	Description	Type	Values	Item No.
	Mag ³ C Power Module	7 Pin PFM	$V_{in} = 6 \dots 24V$; $V_{out} = 0.8 \dots 6V$; $I_{out} = 2A$	171 020 601
C _{Ceramic}	Filter capacitor WCAP-CSGP	EIA-0805	1 μF ; $\pm 10\%$; 50 V; MLCC	885 012 207 103
C _{Ceramic}	Filter capacitor WCAP-CSGP	EIA-0805	22 nF; $\pm 10\%$; 50 V; MLCC	885 012 207 094
C _f	Filter capacitor WCAP-ASLL	5 x 5,5	10 μF ; $\pm 20\%$; 35 V; electrolyte	865 060 542 002
L _f	Filter inductor WE-PD2	5820	4.7 μH ; $I_R = 2.5A$; $R_{DC} = 65m\Omega$	744 774 504 7
C _d	Attenuation capacitor	EIA-1206	47 μF ; $\pm 20\%$; 16 V; MLCC	885 012 109 011
R _d	Attenuation resistance	EIA-1206	1 Ω ; $\pm 1\%$; 0.6 W; metallic layer	

15. Circuit schematic of the 178020601 evaluation board

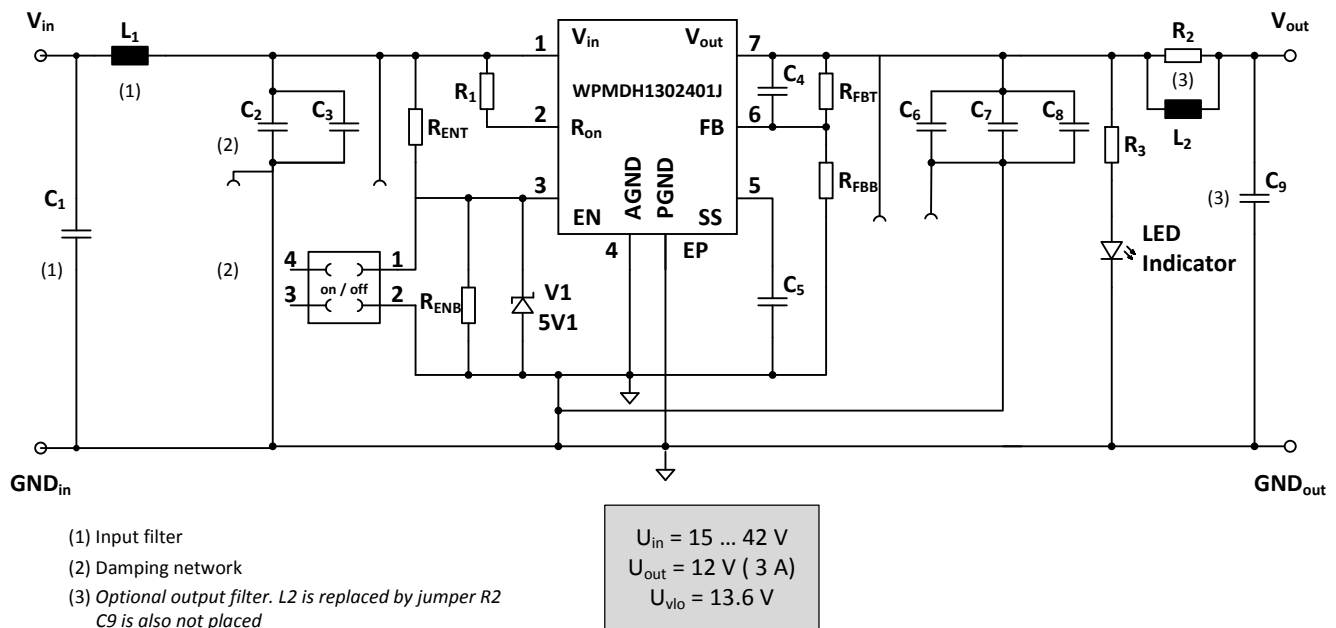

Figure 16: Circuit schematic

16. Recommended components

In accordance with the market demand and the requests of customers of Würth Elektronik eiSos components, filter components are specifically developed for such an application. Filter inductors recommended by Würth Elektronik eiSos are the inductors of the [WE-PD2](#), [WE-TI](#) and [WE-SD](#) product series. The recommended filter capacitors are those in the [WCAP-ASLL](#), [WCAP-PTHR](#) and [WE-CSGP](#) product series.

APPLICATION NOTE

Input Filter for MagI³C Power Modules



16.1. Inductors recommended by Würth Elektronik eiSos for filter applications



Figure 17a
[WE-PD2](#)



Figure 17b
[WE-TI](#)



Figure 17c
[WE-SD](#)

16.2. Capacitors recommended by Würth Elektronik eiSos for filter applications



Figure 18a
[WCAP-ASLL](#)

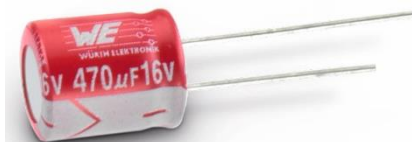

Figure 18b
[WCAP-PTHR](#)



Figure 18c
[WCAP-CSGP](#)

APPLICATION NOTE

Input Filter for Mag³C Power Modules



IMPORTANT NOTICE

The Application Note is based on our knowledge and experience of typical requirements concerning these areas. It serves as general guidance and should not be construed as a commitment for the suitability for customer applications by Würth Elektronik eiSos GmbH & Co. KG. The information in the Application Note is subject to change without notice. This document and parts thereof must not be reproduced or copied without written permission, and contents thereof must not be imparted to a third party nor be used for any unauthorized purpose.

Würth Elektronik eiSos GmbH & Co. KG and its subsidiaries and affiliates (WE) are not liable for application assistance of any kind. Customers may use WE's assistance and product recommendations for their applications and design. The responsibility for the applicability and use of WE Products in a particular customer design is always solely within the authority of the customer. Due to this fact it is up to the customer to evaluate and investigate, where appropriate, and decide whether the device with the specific product characteristics described in the product specification is valid and suitable for the respective customer application or not.

The technical specifications are stated in the current data sheet of the products. Therefore the customers shall use the data sheets and are cautioned to verify that data sheets are current. The current data sheets can be downloaded at www.we-online.com. Customers shall strictly observe any product-specific notes, cautions and warnings. WE reserves the right to make corrections, modifications, enhancements, improvements, and other changes to its products and services.

WE DOES NOT WARRANT OR REPRESENT THAT ANY LICENSE, EITHER EXPRESS OR IMPLIED, IS GRANTED UNDER ANY PATENT RIGHT, COPYRIGHT, MASK WORK RIGHT, OR OTHER INTELLECTUAL PROPERTY RIGHT RELATING TO ANY COMBINATION, MACHINE, OR PROCESS IN WHICH WE PRODUCTS OR SERVICES ARE USED. INFORMATION PUBLISHED BY WE REGARDING THIRD-PARTY PRODUCTS OR SERVICES DOES NOT CONSTITUTE A LICENSE FROM WE TO USE SUCH PRODUCTS OR SERVICES OR A WARRANTY OR ENDORSEMENT THEREOF.

WE products are not authorized for use in safety-critical applications, or where a failure of the product is reasonably expected to cause severe personal injury or death. Moreover, WE products are neither designed nor intended for use in areas such as military, aerospace, aviation,

nuclear control, submarine, transportation (automotive control, train control, ship control), transportation signal, disaster prevention, medical, public information network etc. Customers shall inform WE about the intent of such usage before design-in stage. In certain customer applications requiring a very high level of safety and in which the malfunction or failure of an electronic component could endanger human life or health, customers must ensure that they have all necessary expertise in the safety and regulatory ramifications of their applications. Customers acknowledge and agree that they are solely responsible for all legal, regulatory and safety-related requirements concerning their products and any use of WE products in such safety-critical applications, notwithstanding any applications-related information or support that may be provided by WE. CUSTOMERS SHALL INDEMNIFY WE AGAINST ANY DAMAGES ARISING OUT OF THE USE OF WE PRODUCTS IN SUCH SAFETY-CRITICAL APPLICATIONS.

USEFUL LINKS

Application Notes:

<http://www.we-online.com/app-notes>

REDEXPERT Design Tool:

<http://www.we-online.com/redexpert>

Toolbox:

<http://www.we-online.com/toolbox>

Product Catalog:

<http://katalog.we-online.de/en/>

CONTACT INFORMATION

Würth Elektronik eiSos GmbH & Co. KG

Max-Eyth-Str. 1, 74638 Waldenburg, Germany

Tel.: +49 (0) 7942 / 945 – 0

Email: appnotes@we-online.de

Web: <http://www.we-online.com>