

REDCUBE Terminals for high current applications

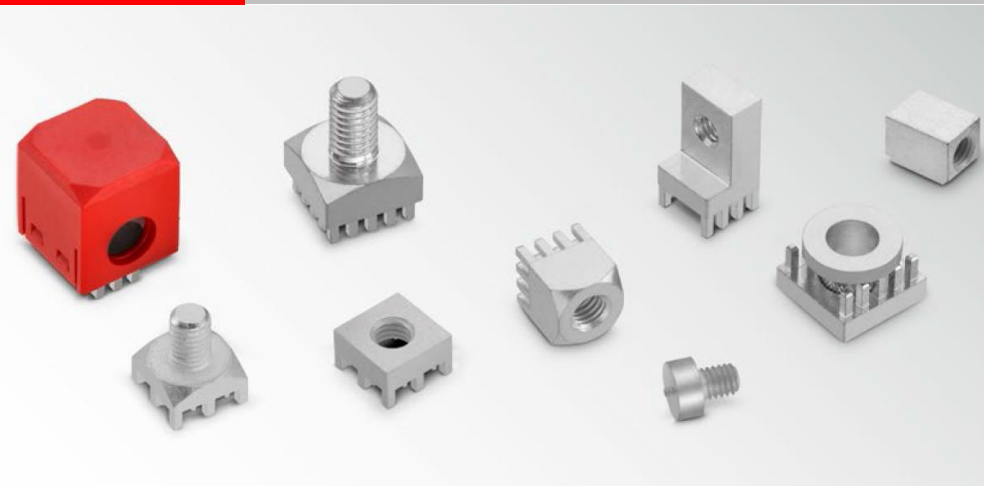

4power!

Content



Press-Fit Technology

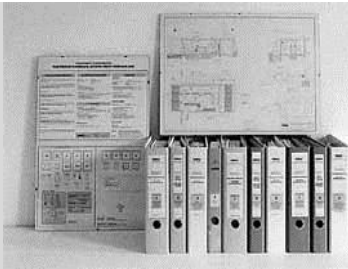

Technical Information & Applications



Processing

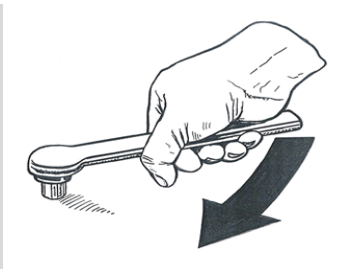

Permitted Torques

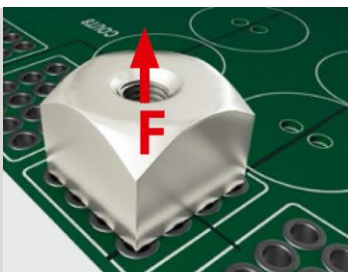

Characteristics & Product overview

Press-Fit Technology



REDCUBE Terminals are the most reliable high-power contacts on PCB level. The current rating of **REDCUBE** PRESS-FIT is impressive. With the same ampacity, the components have the lowest heat development compared to other parts that supply power for PCBs.

Pressing the pins into the PCB, a high friction between pin and plated through-hole generates a homogenous cold-welding between the pin and the copper plated via in the PCB. This results in a gastight, strong mechanical connection with **contact resistance less than 200 μOhm** . No other technology transmits **currents up to 500 A** with such low self-heating.

The via for a press-fit system is essentially made in the same way as the holes for accepting components for THT soldering. Thus there are no changes required in the manufacture of printed circuit boards.

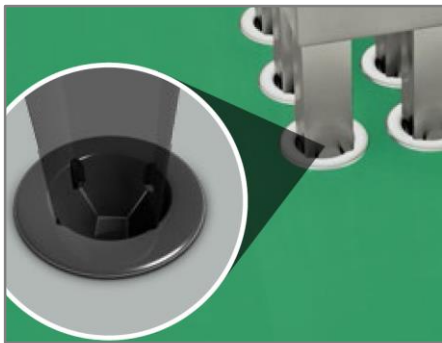

PRESS-FIT Technology

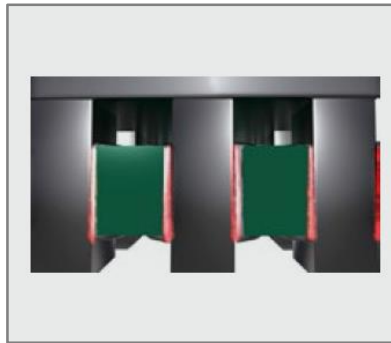

Homogeneous cold welding

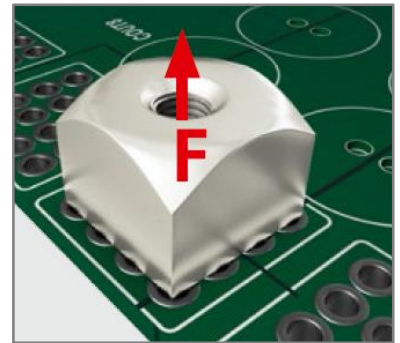

Extraction force 10 kg/pin

With regard to long-term reliability, **REDCUBE** PRESS-FIT is an improvement since it has the lowest **FIT** value (Failure in Time) of the overall system. It is up to 30 times better than the FIT value of an SMT solder joint. A single solid press pin has a typical **extraction force of 100 N** for 1.6 mm PCB. So a small component with 8 pins could withstand a weight load of an average person without extraction out of the PCB. Therefore **REDCUBE** PRESS-FIT Terminals are perfect to provide not only electrical but also mechanical connection solutions for electrical components.

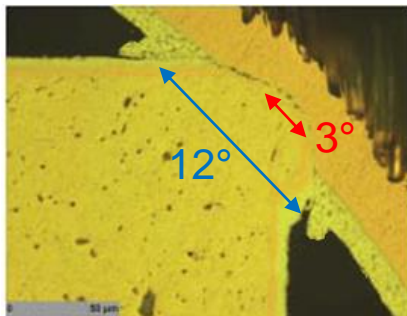

If after press-fit process a solid press pin in a 2.4 mm thick printed circuit board fits on each corner with more than 3° against the sleeve, the press connection zone has a lower electrical resistance than the brass pin itself and thus does not pose an electrical or thermal bottleneck. The connection surface angle is normally much greater, which provides a generous safety buffer for the electrical connection.

Required connection angle only 3°

Press-Fit Technology



Advantages of REDCUBE PRESS-FIT

- Very high ampacity
- Ideally suited for continuous and peak currents
- Extremely high environmental stability
- Suitable for rough environmental conditions
- Low-resistance connection (<math><200 \mu\text{Ohm}</math>)
- No cold solder joints
- Double sided mounting
- Space saving design

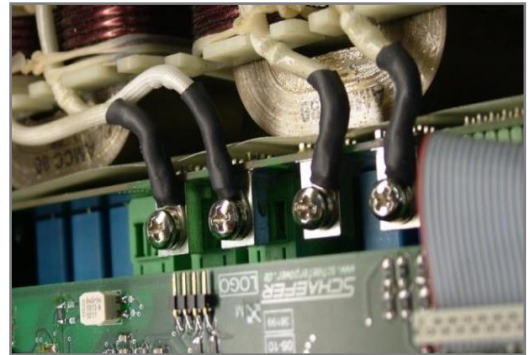

Press-fit technology provides a number of advantages in comparison to solder technology. Very thick circuit boards with high copper plating can be processed easily. Furthermore, **two-sided mounting** of circuit boards is possible without any problems which usually enable a very compact design of modules. As a result, current paths in particular are shortened which is thermally very beneficial for the processing of high currents.

There is reliable contact between pin and copper layer over the complete case length of a press-fit zone. It is not guaranteed for soldering that the solder rises the complete length of the via whereby many higher transition resistances are produced. Therefore, long-term reliability and mechanical stability are also not as high as with **REDCUBE PRESS-FIT**.

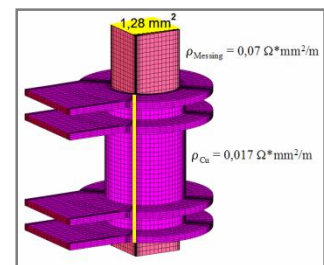
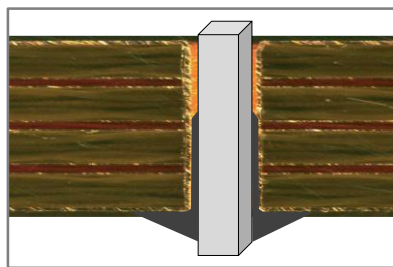

The processing of **REDCUBE PRESS-FIT** Terminals integrates seamlessly in the production process of the systems and is thus very cost-effective. Several **REDCUBE PRESS-FIT** can be press-fitted simultaneously using press-fitting tools. In doing so, the circuit boards, in contrast to soldering, are not loaded thermally.

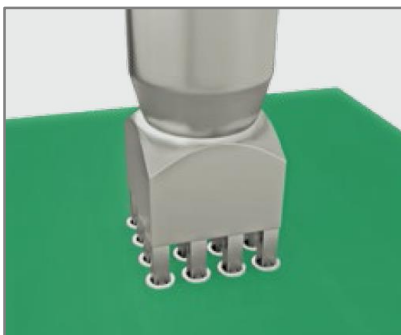

Technical Information



Materials and tolerances

REDCUBE PRESS-FIT from Würth Elektronik are manufactured from the material CuZn39Pb3 and are therefore RoHS-compliant according to the RoHS stipulation concerning copper alloys.

The circuit board thickness should ideally be between 1.6 and 3.2 mm. Tested surfaces are chemical tin, HAL and ENIG. The **immersion tin** coating process is recommended. Using this process usually guarantees that the tin is evenly distributed in the case whereby the tolerances can be complied with more easily and thus chip formation can be prevented. Due to the uneven distribution of the tin in the case for the HAL process, we recommend the immersion tin process for circuit board thickness of 2.4 mm and greater. ENIG can be used but not recommended for Press-Fit technology.

Unless otherwise noted in the corresponding drawing, Würth Elektronik **REDCUBE** PRESS-FIT have quadratically designed press-fit pins. The through-hole plating in the PCB must therefore have the following characteristics:

Specification for chemical surfaces

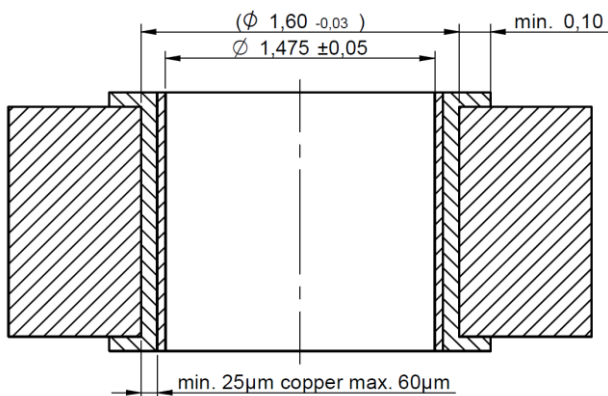

Specification for Hot-Air-Levelling

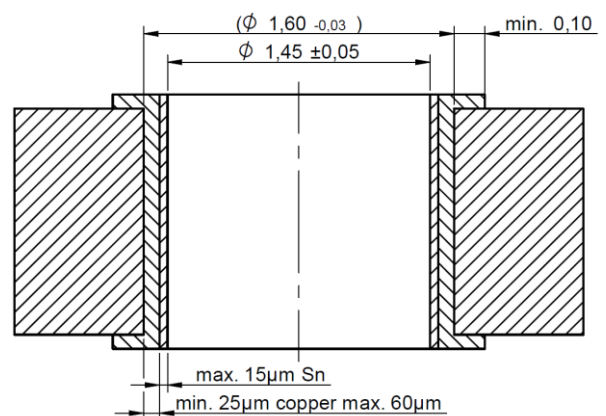

Current load

With **REDCUBE** PRESS-FIT Terminals from Würth Elektronik, currents of more than **500 A** can be carried on the circuit board. The current-carrying capacity of **REDCUBE** PRESS-FIT must always be considered in the context of the complete system. Many factors such as conductor path thickness, conductor path width, cable cross section, ambient temperature and heat distribution should be taken into account for the selection of the individual **REDCUBE** PRESS-FIT.

In comparison with a solder connection ($R = 300$ to $400 \mu\text{Ohm}$), the press-fit zone itself with 100 to 200 μOhm has extremely low resistance so that the **limiting factor** can usually be found in the layout of the connected **conductor paths** or the **connection of external feed lines** to a press-fitted component.

The challenge in designing high current applications lies in the optimal interaction of all components of the system!

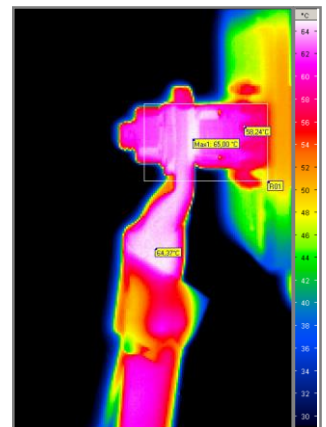

Applications

REDCUBE PRESS-FIT have a very wide range of possible applications: They are used very frequently in the connection of wiring with cable lugs on circuit boards.



Application up to 160 A



Application up to 300 A

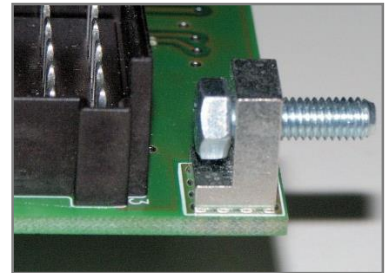

Housing assembling

The mounting of a copper rail for increasing the current-carrying capacity is also possible by using **REDCUBE PRESS-FIT**. In doing so, the copper rail can be installed in two different ways: on the one hand, it can be press-fitted under the circuit board and on the other hand, it can be screwed onto the **REDCUBE PRESS-FIT**. For the press-fit process, the maximum overall thickness of the circuit board with the copper rail must not exceed 3.2 mm.

REDCUBE PRESS-FIT is an ideal possibility for mounting laminated fuses.

Furthermore **REDCUBE PRESS-FIT** are ideally suited for fulfilling purely mechanical functions such as connections of circuit board and case or connecting two circuit boards with each other.

The two-part **REDCUBE PRESS-FIT** Board-to-Board connection realizes a very high mechanical stability with current carrying capacity up to 320 A.

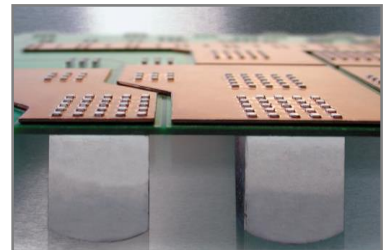

Pressing: PCB directly with copper bar

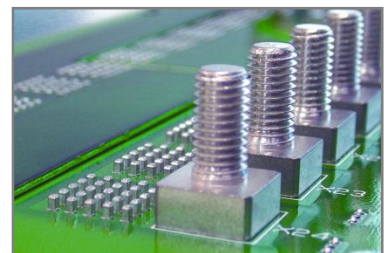

Double-sided mounting



Mounting of laminated fuses

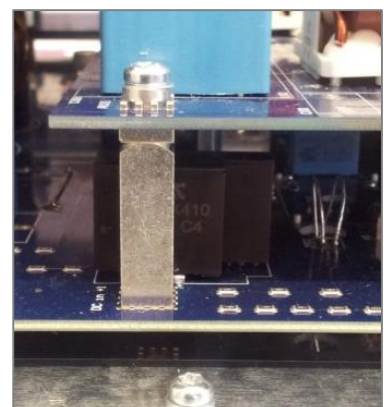

High current Board-to-Board connection up to 200 A

Processing

REDCUBE PRESS-FIT

- Other components should be spaced at least 4 mm away from the press-fit hole.
- The hole should be at least 3 mm away from the edge.
- No special tools are necessary, usually a simple lever press is sufficient.
- The press-fit force per pin should be min. 40 N and max. 250 N. For 1.6mm PCB typically this force is about 100-150 N/pin.
- The press-fit zone must be supported during the whole press-fit process. Without support, deflection of the circuit board can occur during pressing in. It must particularly be ensured for pneumatic presses that the stroke cycle is not performed unevenly but evenly.
- The stroke cycle should be performed at right angles to the circuit board. After the press-fitting, the pins should slightly protrude from the circuit board. The components should not be pressed against the board. A separation of approx. 0.1 mm between the circuit board and bin socket is recommended.
- For two-part **REDCUBE PRESS-FIT**, the base element must always be pressed to the circuit board first.

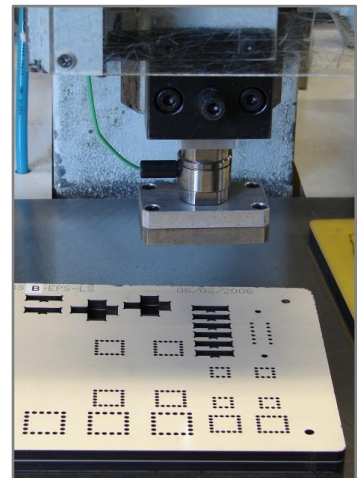

Cautions for solderability

- Our **REDCUBE PRESS-FIT** are designed for press fit. Alternative processing methods, such as soldering, are not recommended.
- Due to the high heat absorption, press fitting of the **REDCUBE PRESS-FIT** should be performed last and after all soldering processes are finished.
- It is also not recommended to re-solder **REDCUBE PRESS-FIT** after the press-fit process. Re-soldering can result in partial destruction of the cold weld and delamination in the circuit board whereby mechanical stability of the press-fit zone can be permanently lost.
- For solderable high-current solutions we recommend our **REDCUBE THR** & **REDCUBE SMD Terminals**.

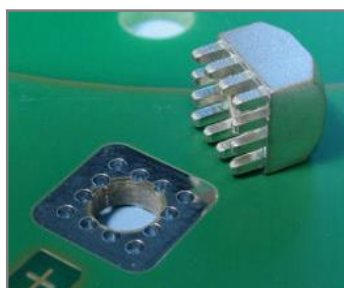

Permitted Torques



REDCUBE PRESS-FIT provide wide area connection and carrying of high currents in circuit boards. To prevent mechanical destruction of the **REDCUBE PRESS-FIT** the maximum permissible torques must be complied with! Due to the material, these differ significantly from standard fastening materials (steel) used.

Mechanical characteristics (guide values):

- Material: CuZn39Pb3
- Shear strength: 350 N/mm²
- Tensile strength: 480 N/mm²
- Yield strength: 340 N/mm²
- Elongation: 20%
- E-modulus: 96 kN/mm²
- Torsional modulus: 32 kN/mm² (shear modulus)

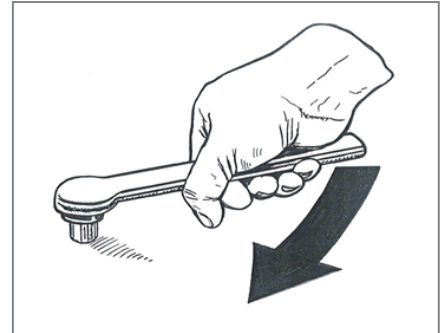

Table for **REDCUBE PRESS-FIT / Shank / Full Plain Pin-Plate**

Thread dimension (metric)	M3	M4	M5	M6	M8	M10
Max. tightening torque [Nm] *	0.5	1.2	2.2	3.9	9.0	17.0
Breaking torque [Nm] **	1.5	4.0	6.0	10	32.5	32.5
Breaking torque pins [Nm] ***	9	16	16	25	25	36

* Based on DIN EN 20898 T7 Part 25 (tightening torques); values for brass material (MS 63)

** Determined values (torques). For these mechanical loads, destruction of the threaded shank occurs. The components must never be loaded up to these values.

*** Determined values (torques). For these mechanical loads, destruction of the press-fit pins occurs (approx. 1 Nm/pin). The components must never be loaded with these values.

The maximum permissible torque changes greatly with the material composition (alloy parts). Safety margins must also be taken into account for practical use.

For this reason, **REDCUBE PRESS-FIT** are only permitted to be loaded with the tightening torque values for brass material - (according to row 2 / table)!

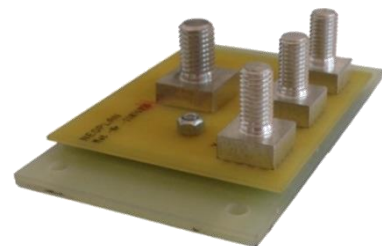

Characteristics



REDCUBE PRESS-FIT

- Material: Brass
- Surface: tin plated
- Holding forces according to IEC 352-5
- Press-in force: max. 250 N per pin, min. 40 N per pin
- Extraction force: typically about 100 N per pin
- PCB thickness: 1.6 - 3.2 mm
- Force-fitting speed: 100 - 250 mm/min

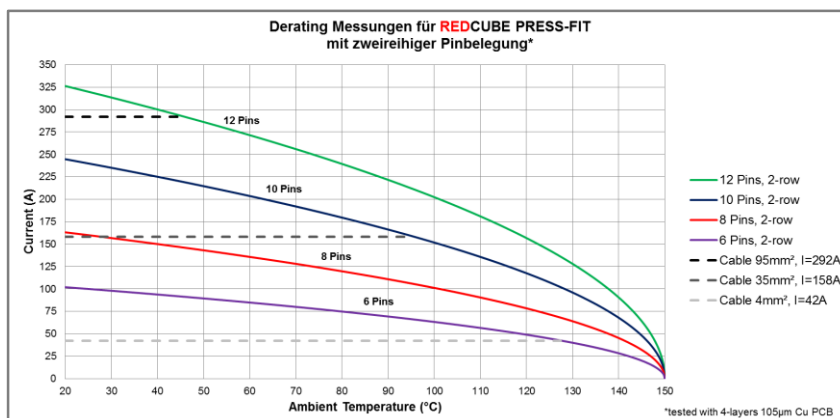
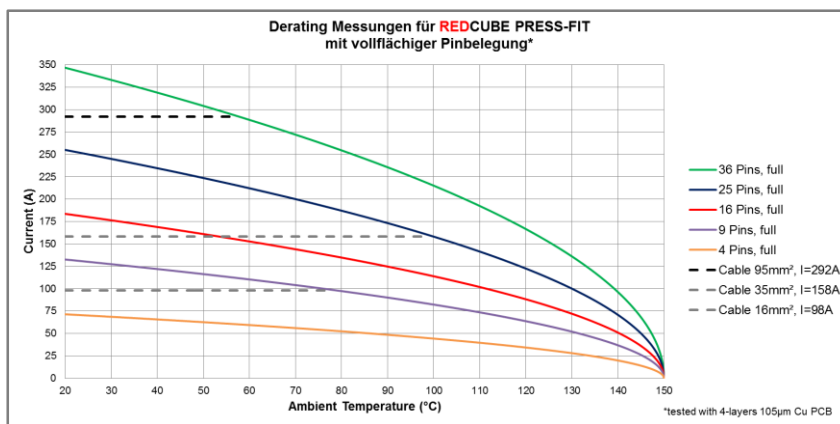
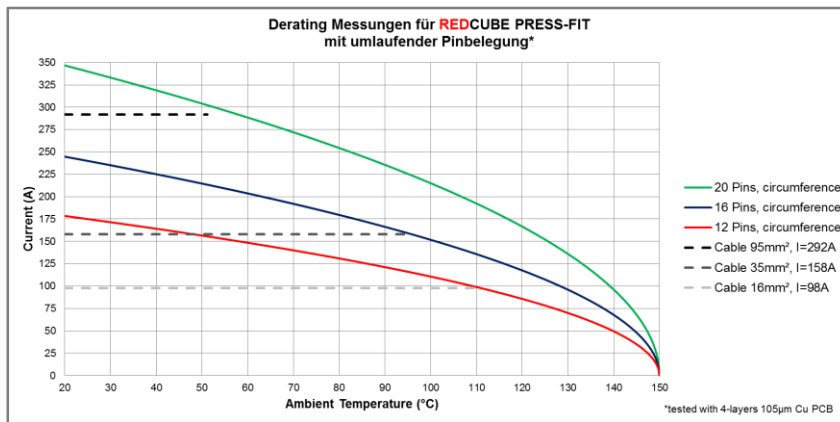
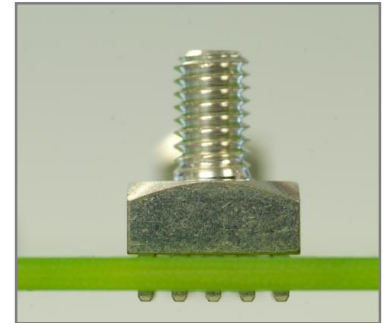

Product Preview



The new quick and easy pluggable solution **REDCUBE PLUG** offers all Press-Fit advantages; it is a multiple times pluggable solution for high-current applications up to 120 A.

REDCUBE PLUG consists of a **REDCUBE PRESS-FIT** high-current contact, surrounded by a glass fiber-reinforced plastic housing. Pushing on the top of the housing allows mating the corresponding cable connector. After actuating the spring returns to its initial position and locks the cable connector automatically into the housing.

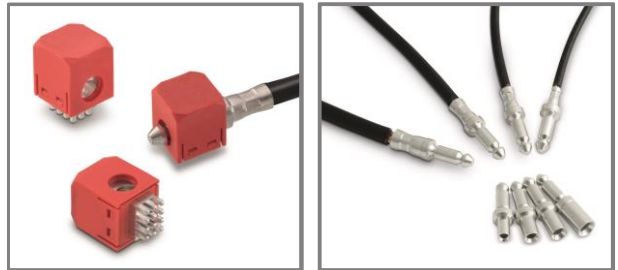

REDCUBE Direct PLUG Terminal

- Insulator Material: PBT
- Contact Material: Copper alloy
- Contact Plating: Tin

Cable Connector for REDCUBE PLUG

- Material: Copper alloy
- Surface: Tin-plated
- Cross-sections: 4 – 16 mm²

Applications

- High current and reversible Wire-to-Board connections
- Battery charger
- Multiple times pluggable solutions
- Tool-free assembly
- Mounting areas with difficult access

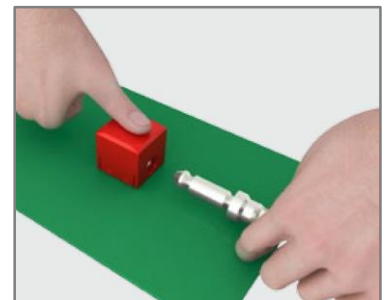

Processing

The press-fit process of **REDCUBE PLUG** is similar to **REDCUBE Press-Fit**. Therefore, no additional tools are necessary. A general hexagonal crimper is used to install the contact on to the wire. This simple lug like crimp set the bond in place. The cable connector for the **REDCUBE PLUG** is available in four different cross sections. A special posttreatment technology and a specific plating of the cable connector guarantee optimal crimping results.

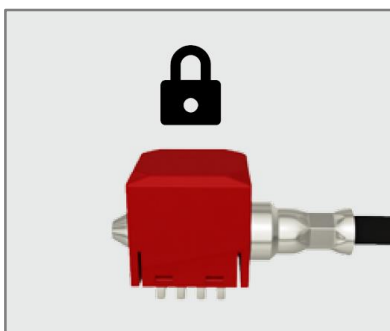

Automatic locking

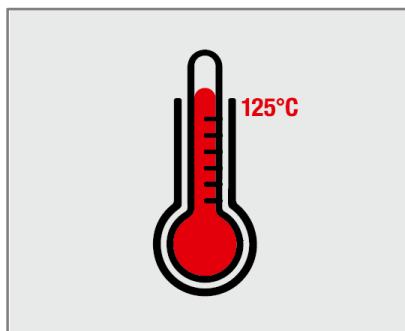

Heat resistance up to +125°C



Gas-tight crimp connection

Product Preview



Derating REDCUBE PLUG

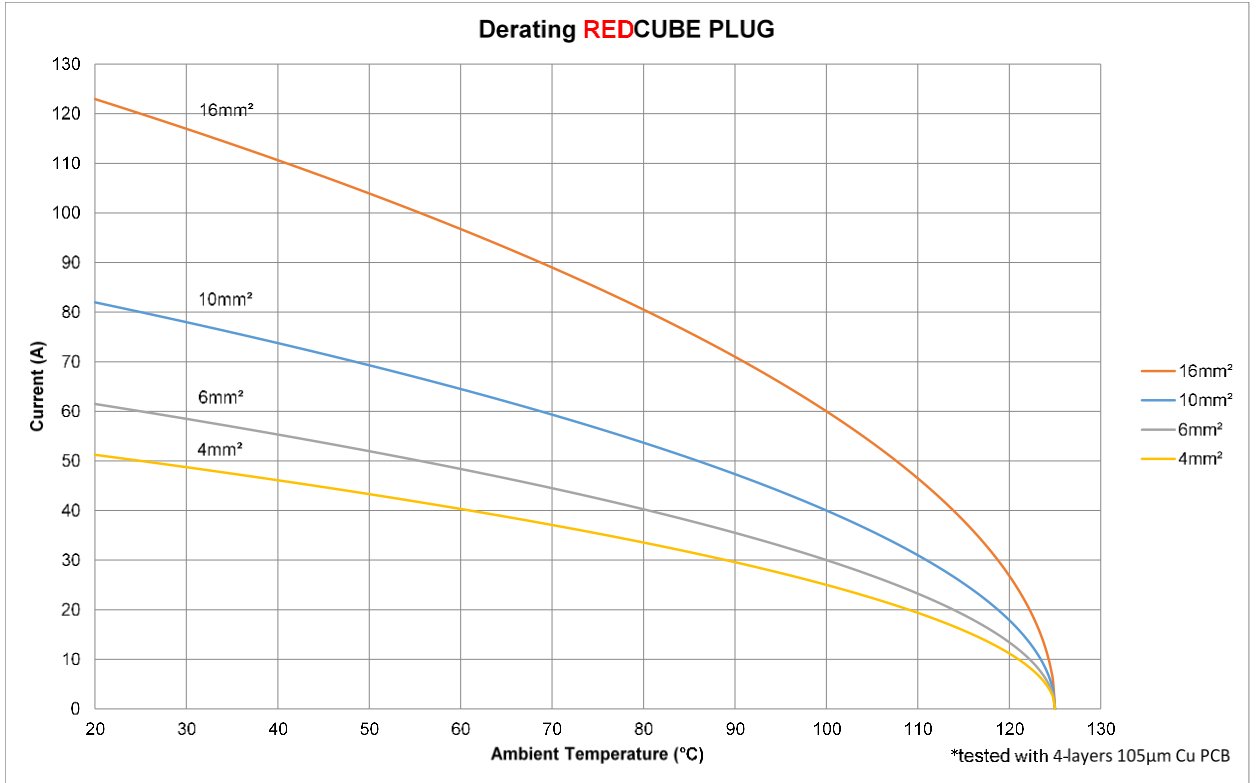

Reliability Test



The reliability of **REDCUBE PRESS-FIT** Terminals is often proved in different qualification programs, tests and in field.

Press-fit requirements according to:

- **IEC60352-5** Solderless connections - Part 5: Press-in connections - General requirements, test methods and practical guidance

Environmental tests according to:

- **IEC 60068-2-14:** Environmental testing - Part 2-14: Tests - Test N: Change of temperature,
 - ✓ Thermal Shock, -55°C/+150°C, 1000h
- **IEC 60068-2-30 / MIL-STD-202 Method 106** Environmental testing - Part 2-30: Tests - Test Db: Damp heat, cyclic
 - ✓ Moisture Resistance, 65±2 °C, 95%RH, 500h

Mechanical tests according to:

- **IEC 60068-2-6** Environmental testing - Part 2-6: Tests - Test Fc: Vibration (sinusoidal)
 - ✓ Vibration, 15g's for 20 minutes, 10 Hz to 1500 Hz, 12 cycles per axis

Electrical tests according to:







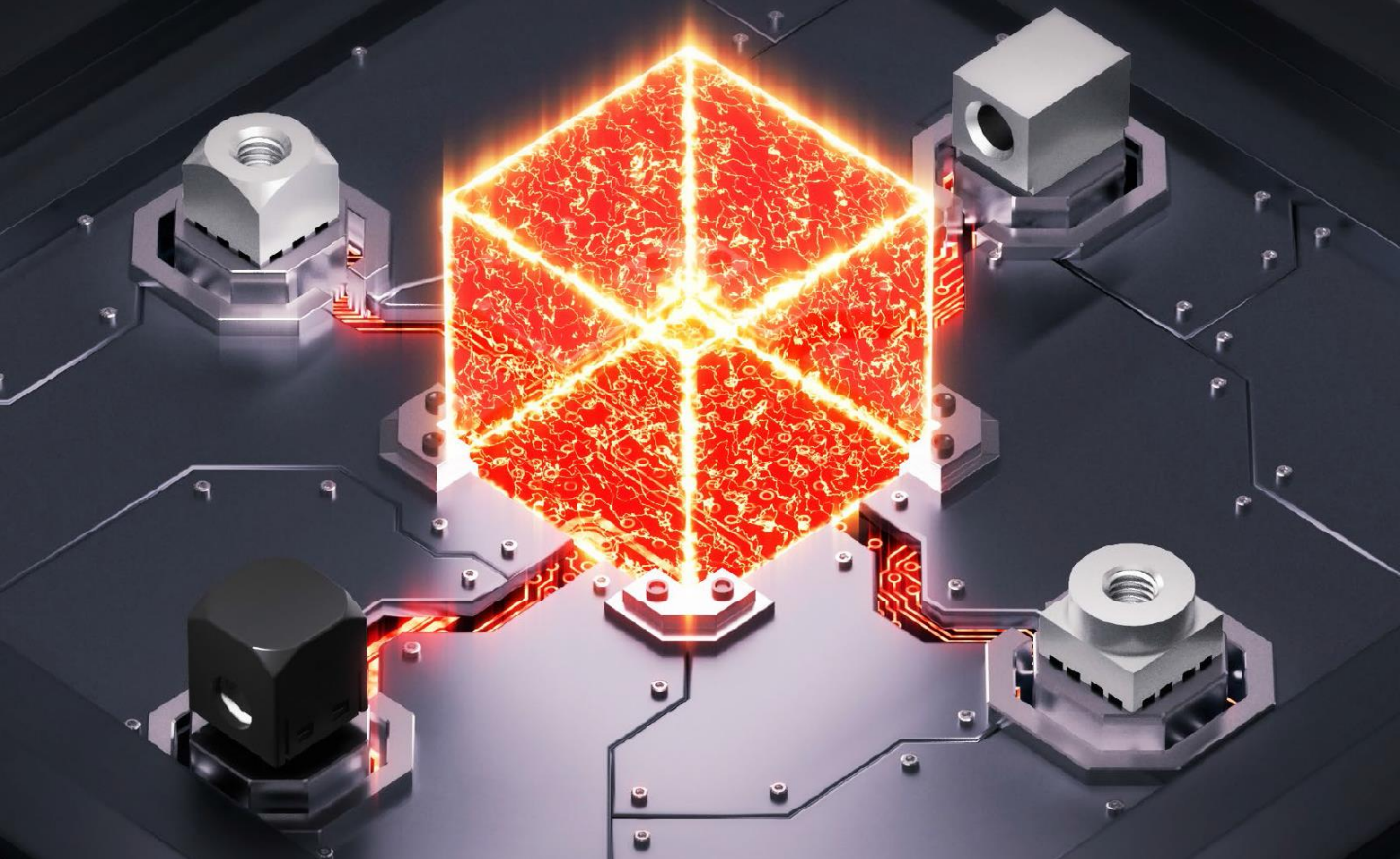



- **IEC 60512-2-1** Connectors for electronic equipment - Tests and measurements - Part 2-1: Electrical continuity and contact resistance tests; Test 2a: Contact resistance; Millivolt level method
- **IEC 60512-2-5** Connectors for electronic equipment - Tests and measurements - Part 5-2: Current-carrying capacity tests; Test 5b: Current-temperature derating

- **REDCUBE PRESS-FIT** show extremely high environmental stability
- Requirements of the relevant standards are greatly exceeded

4 power!



Overview

REDCUBE TERMINALS	THREAD SIZE / DIAMETER	TYPE	CONNECTION TO REDCUBE	PACKAGING	CURRENT UP TO (+20°C)	OPERATING TEMPERATURE
REDCUBE PRESS-FIT	 M2.5 – M10	Internal Thread	Screwable Connection	Bulk	500A	-55°C to +150°C
	 M3 – M10	External Thread				
	 M3 – M10 Ø3.2 – Ø8.2	Right Angled				
	 M3 – M8 Ø3.2 - Ø10.5	Two Part				
REDCUBE PLUG	 Cable Cross Section: 4mm ² – 16mm ²	–	Pluggable Connection	Bulk	120A	-45°C to +125°C
REDCUBE SMD	 M3 – M5	Internal Thread	Screwable Connection	Bulk, Tape & Reel	70A	-55°C to +150°C
	 M3 – M4	External Thread				
	 M3 Ø3.3	Right Angled				
REDCUBE THR	 M3 – M5	Internal Thread	Screwable Connection	Bulk, Tape & Reel	85A	-55°C to +150°C
	 M3 – M5	External Thread				

*Operating current is defined by the PCB, cross section of the cable and cable lug. Suggested cable cross section according to VDE 0100.

more than you expect

Passive & Electromechanical Components

www.we-online.com



Würth Elektronik eiSos GmbH & Co. KG

Max-Eyth-Str. 1

74638 Waldenburg

www.we-online.de

Phone: +49 (0) 79 42 945 5292

Fax: +49 (0) 79 42 945 5329

eiCan@we-online.de

According to our knowledge, the information provided is accurate and reliable; however Würth Elektronik eiSos shall not accept any responsibility for use in any application which does not comply with the present specification. Würth Elektronik eiSos reserves the right to change specifications at any time in the course of technical progress. Subject to dimensional changes. Dimensions, data, illustrations and descriptions comply with the state of the art at the time of issue of this catalog; however these are not binding! Subject to change. We accept no responsibility for errors and omissions and printing errors.