

### Description

- Standard 2 x 1.6mm crystal oscillator in a hermetically sealed ceramic package with a seam sealed metal lid
- Model IQXO-542
- Model Issue number 7

### Frequency Parameters

- Frequency 27.0MHz
- Frequency Stability  $\pm 50.00\text{ppm}$
- Operating Temperature Range  $-40.00$  to  $85.00^\circ\text{C}$
- Ageing  $\pm 5\text{ppm}$  per year

### Electrical Parameters

- Supply Voltage  $1.8\text{V} \pm 10\%$
- Current Draw  $15.000\text{mA}$  max

### Output Details

- Output Compatibility CMOS
- Drive Capability  $15\text{pF}$  max
- Rise and Fall Time  $7.0\text{ns}$  max
- Duty Cycle  $40/60$  max
- Start up Time:  
1.1ms typ to 90% of final amplitude (under ideal conditions @ $25^\circ\text{C}$ )  
10ms max

### Output Control

- Standby Operation:  
Logic '1' ( $\geq 70\%V_s$ ) to pad 1 enables oscillator output  
Logic '0' ( $\leq 30\%V_s$ ) to pad 1 disables oscillator output; when disabled the oscillator output goes to the high impedance state  
No connection to pad 1 enables oscillator output
- Standby Current:  
 $0.6\mu\text{A}$  typ @ $25^\circ\text{C}$   
 $10\mu\text{A}$  max

### Output Levels

- Output High (VoH): 90% of  $V_s$  min  
Output Low (VoL): 10% of  $V_s$  max

### Environmental Parameters

- Storage Temperature Range:  $-55$  to  $125^\circ\text{C}$
- Shock: Half sine shock pulse with peak acceleration  $500\text{g}$ ;  
Pulse duration:  $0.3\text{ms}$
- Vibration: MIL-STD-202 Method 204.  $5\text{g}$  for 20 minutes, 12 cycles in each of the 3 orientations,  $10 \sim 2000$  Hz. As per Table 11 of AEC-Q200.

### Manufacturing Details

- RoHS Terminations Ni, Au & TI
- RoHS Reflow Temp  $260^\circ\text{C}$  max for 10 seconds

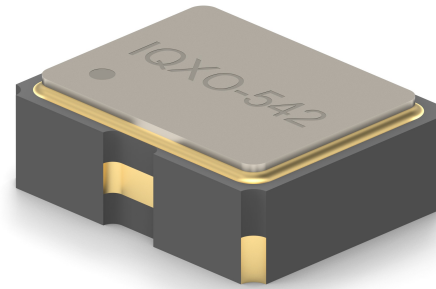

### Outline (mm)

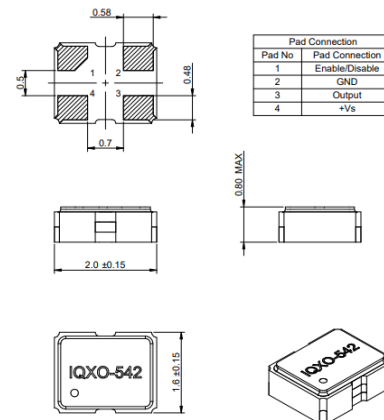

### Recommended Solder Pad Layout

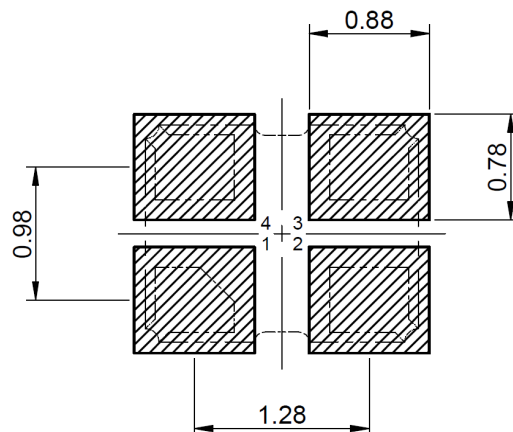

### CONTACT INFORMATION:

Würth Elektronik eiSos GmbH & Co. KG  
Max-Eyth-Str. 1, 74638 Waldenburg, Germany  
Tel: +49(0) 7942 945-0

Email: [eiSos@we-online.de](mailto:eiSos@we-online.de)  
Web: [www.we-online.com](http://www.we-online.com)

### Compliance

- RoHS Status (2015/863/EU)      Compliant
- REACH Status                      Compliant
- MSL Rating (JDEC-STD-033):    Not Applicable

### Packaging Details

- Tape & reel in accordance with EIA-481  
Quantities below the standard reel size to  
be supplied on cut tape.  
Standard Quantity: 3,000 Pieces

### USEFUL LINKS

**Toolbox:**

[www.we-online.com/toolbox](http://www.we-online.com/toolbox)

**Product Catalog:**

[www.we-online.com/products](http://www.we-online.com/products)

### Test Circuit

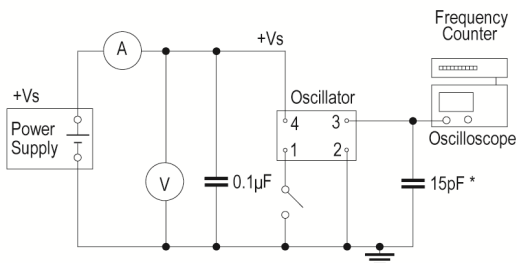

\* Inclusive of jigging and equipment capacitance

### Waveform

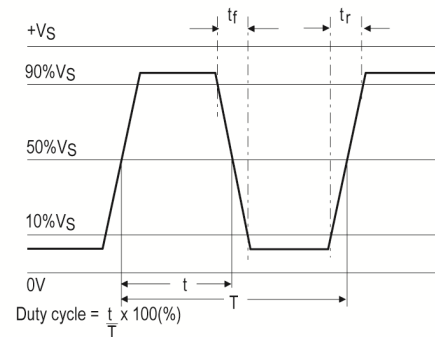

### CONTACT INFORMATION:

Würth Elektronik eiSos GmbH & Co. KG  
Max-Eyth-Str. 1, 74638 Waldenburg, Germany  
Tel: +49(0) 7942 945-0

Email: [eiSos@we-online.de](mailto:eiSos@we-online.de)  
Web: [www.we-online.com](http://www.we-online.com)