

Description

- Surface mount 3.2 x 2.5mm crystal oscillator in a hermetically sealed ceramic package with a seam sealed metal lid.
- Model CFPS-39
- Model Issue number 8
- Note: please be aware that devices supplied against this model may show slight cosmetic differences depending upon the frequency and specification, however all electrical details remain as per the model specification.

Frequency Parameters

- Frequency 25.0MHz
- Frequency Stability $\pm 25.00\text{ppm}$
- Operating Temperature Range -40.00 to 85.00°C
- Ageing $\pm 5\text{ppm}$ max per year @ 25°C

Electrical Parameters

- Supply Voltage $3.3\text{V} \pm 10\%$
- Current Draw 20.000mA max

Output Details

- Output Compatibility CMOS
- Drive Capability 15pF max
- Rise and Fall Time 7.0ns max
- Duty Cycle $40/60$ max
- Output Low VoL: 10% Vs max
- Output High VoH: 90% Vs min
- Start-Up Time: 10ms max

Output Control

- Standby Operation:
Logic '1' ($>70\%$ Vs) to pad 1 enables oscillator output
Logic '0' ($<30\%$ Vs) to pad 1 disables oscillator output; when disabled the oscillator output goes to the high impedance state
No connection to pad 1 enables oscillator output
Standby Current: $10\mu\text{A}$ max

Noise Parameters

- RMS Phase Jitter:
Frequency range 10MHz to 39.9MHz :
Phase Jitter (12kHz to 5MHz): 1ps rms max
Frequency range 40MHz to 125MHz :
Phase Jitter (12kHz to 20MHz): 1ps rms max

Environmental Parameters

- Storage Temperature Range: -55 to 125°C
- Shock: Half Sine shock pulse with peak acceleration 500g ; Pulse duration: 0.3ms
- Vibration: MIL-STD-202 Method 204. 5g for 20 minutes, 12 cycles in each of the 3 orientations, $10 - 2000$ Hz. As per Table 11 of AEC-Q200.

Manufacturing Details

- RoHS Terminations NiAu
- RoHS Reflow Temp 260°C max for 10s max



Outline (mm)

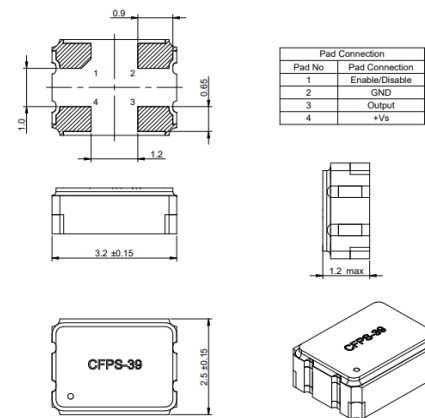

Recommended Solder Pad Layout

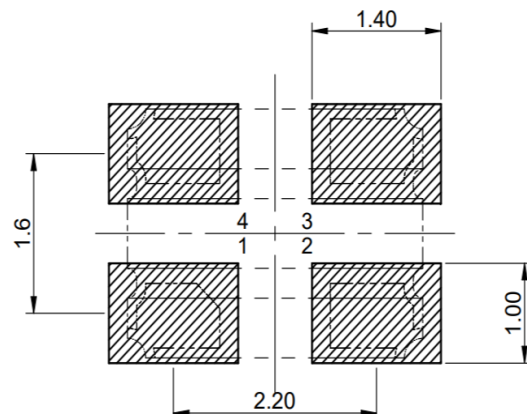

CONTACT INFORMATION:

Würth Elektronik eiSos GmbH & Co. KG
Max-Eyth-Str. 1, 74638 Waldenburg, Germany
Tel: +49(0) 7942 945-0

Email: eiSos@we-online.de
Web: www.we-online.com

Compliance

- RoHS Status (2015/863/EU) Compliant
- REACH Status Compliant
- MSL Rating (JDEC-STD-033): Not Applicable

Packaging Details

- Tape & reel in accordance with EIA-481
Quantities below the standard reel size to
be supplied on cut tape
Standard Quantity: 3,000 Pieces

USEFUL LINKS

Toolbox:

www.we-online.com/toolbox

Product Catalog:

www.we-online.com/products

Test Circuit

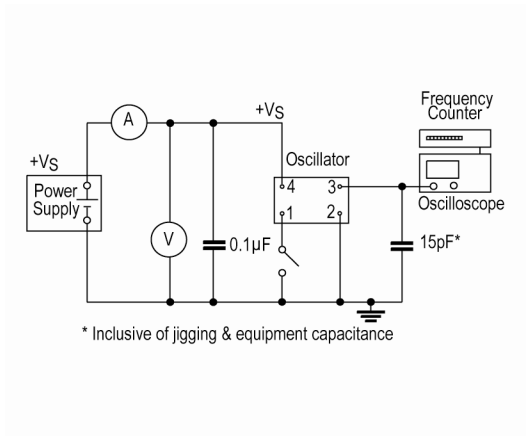

Waveform

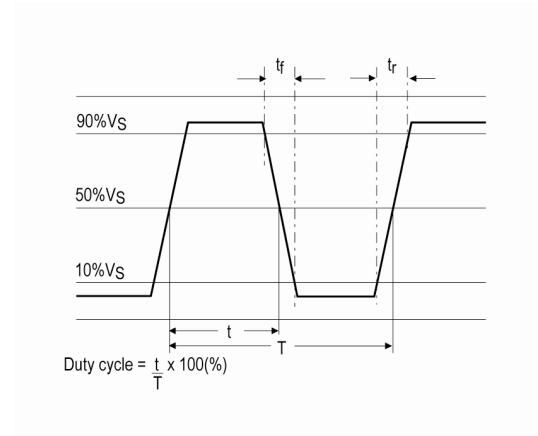

CONTACT INFORMATION:

Würth Elektronik eiSos GmbH & Co. KG
Max-Eyth-Str. 1, 74638 Waldenburg, Germany
Tel: +49(0) 7942 945-0

Email: eiSos@we-online.de
Web: www.we-online.com