

### Description

- Standard 7.0 x 5.0mm crystal oscillator in a ceramic package with a seam sealed metal lid, hermetically sealed.
- Model CFPS-73
- Model Issue number 16

### Frequency Parameters

- Frequency 4.0MHz
- Frequency Stability  $\pm 50.00$ ppm
- Operating Temperature Range -40.00 to 85.00°C
- Ageing  $\pm 5$ ppm per year

### Electrical Parameters

- Supply Voltage 3.3V  $\pm 10\%$
- Current Draw 7.000mA max
- Note: parameters are referenced to 15pF load

### Output Details

- Output Compatibility CMOS
- Drive Capability 15pF typ, 30pF max
- Rise and Fall Time 10.0ns max
- Duty Cycle 40/60 max
- Start up time: 10ms max, 0.9ms typ to 90% of final amplitude ( under ideal conditions @25°C).

### Output Control

- Standby Operation:  
Logic '1' (>70% VS) to pad 1 enables oscillator output  
Logic '0' (<30% VS) to pad 1 disables oscillator output; the oscillator output goes to the high impedance state  
No connection to pad 1 enables oscillator output  
Standby Current: 10µA max, 0.9µA typ @25°C.

### Environmental Parameters

- Shock: Half Sine shock pulse with peak acceleration 500g; Pulse duration: 0.3ms
- Vibration: MIL-STD-202 Method 204. 5g for 20 minutes, 12 cycles in each of the 3 orientations, 10 - 2000 Hz. As per Table 11 of AEC-Q200.
- Storage Temperature Range: -55 to 125°C

### Manufacturing Details

- RoHS Terminations NiAu
- RoHS Reflow Temp 260°C 10s max

### Compliance

- RoHS Status (2015/863/EU) Compliant
- REACH Status Compliant
- MSL Rating (JEDEC-STD-033): Not Applicable



### Outline (mm)

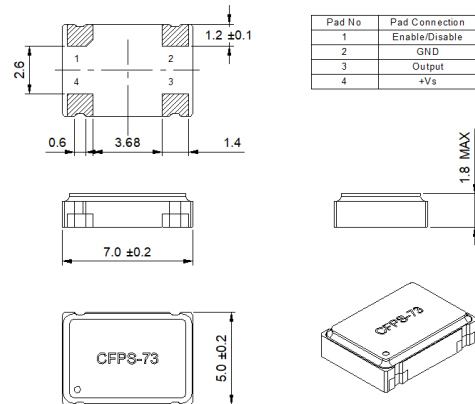

### Recommended Solder Pad Layout

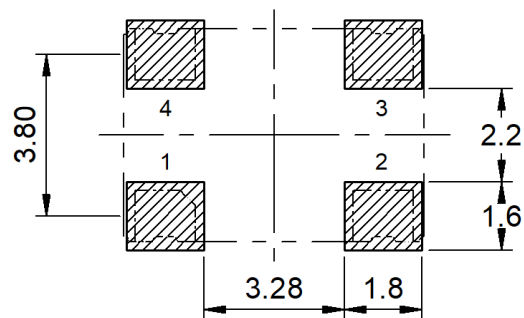

### CONTACT INFORMATION:

Würth Elektronik eiSos GmbH & Co. KG  
Max-Eyth-Str. 1, 74638 Waldenburg, Germany  
Tel: +49(0) 7942 945-0

Email: eiSos@we-online.de  
Web: www.we-online.com

### Packaging Details

- Tape & reel in accordance with EIA-481  
Quantities below the standard reel size to be supplied on cut tape.  
Standard Quantity: 1,000 Pieces

### USEFUL LINKS

Toolbox:

[www.we-online.com/toolbox](http://www.we-online.com/toolbox)

Product Catalog:

[www.we-online.com/products](http://www.we-online.com/products)

### Test Circuit

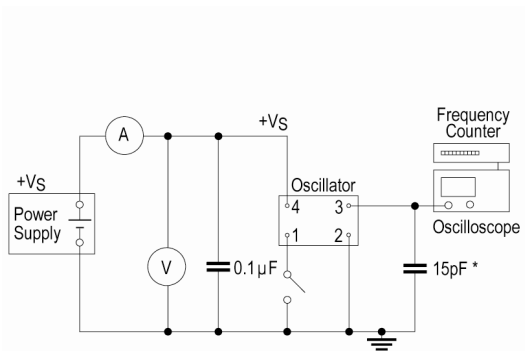

\* Inclusive of jigging and equipment capacitance

### Waveform

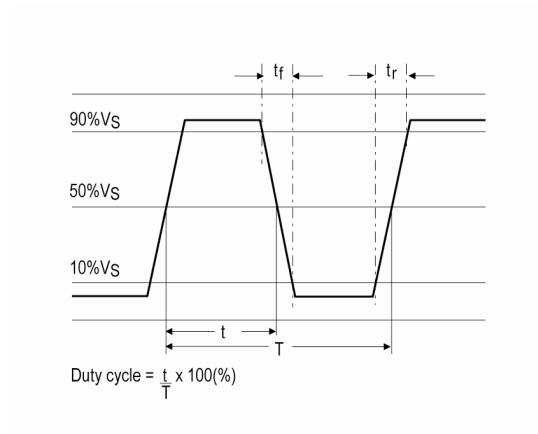

### CONTACT INFORMATION:

Würth Elektronik eiSos GmbH & Co. KG  
Max-Eyth-Str. 1, 74638 Waldenburg, Germany  
Tel: +49(0) 7942 945-0

Email: [eiSos@we-online.de](mailto:eiSos@we-online.de)  
Web: [www.we-online.com](http://www.we-online.com)