

### Description

- Standard 2.5 x 2.0 oscillator in a ceramic package with a hermetically sealed metal lid.
- Model: IQXO-794
- Model Issue number: 4

### Frequency Parameters

- Frequency: 20.0MHz
- Frequency Stability:  $\pm 25.00$ ppm
- Operating Temperature Range: -20.00 to 70.00°C
- Ageing:  $\pm 5$ ppm per year

### Electrical Parameters

- Supply Voltage: 1.8V  $\pm 10\%$
- Current Draw: 12.000mA max

### Output Details

- Output Compatibility: CMOS
- Drive Capability: 15pF max
- Rise and Fall Time: 7.0ns max
- Duty Cycle: 40/60 max
- Start Up Time:  
0.9ms typ to 90% of final amplitude (under ideal conditions @25°C)  
10ms max
- Output Voltage Levels:  
Output Low (VoL): 10% Vs max  
Output High (VoH): 90% Vs min

### Output Control

- Enable/Disable:  
Logic '1' ( $\geq 70\%$  Vs) to pad 1 enables oscillator output.  
Logic '0' ( $\leq 30\%$  Vs) to pad 1 disables oscillator output. When disabled the oscillator output goes to the high impedance state.  
No connection to pad 1 enables oscillator output.
- Standby Current:  
0.5 $\mu$ A typ @25°C  
10 $\mu$ A max

### Noise Parameters

- Period Jitter (pk-pk):  $\pm 80$ ps typ
- Period Jitter (1 $\sigma$ ):  $\pm 10$ ps typ
- RMS Phase Jitter (12kHz to 20MHz): 1ps max

### Environmental Parameters

- Storage Temperature Range: -55 to 125°C
- Shock: Half Sine shock pulse with peak acceleration 500g; Pulse duration: 0.3ms
- Vibration: MIL-STD-202 Method 204. 5g for 20 minutes, 12 cycles in each of the 3 orientations, 10 ~ 2000 Hz. As per Table 11 of AEC-Q200.

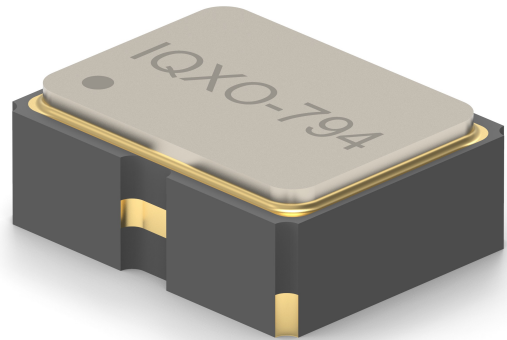

### Outline (mm)

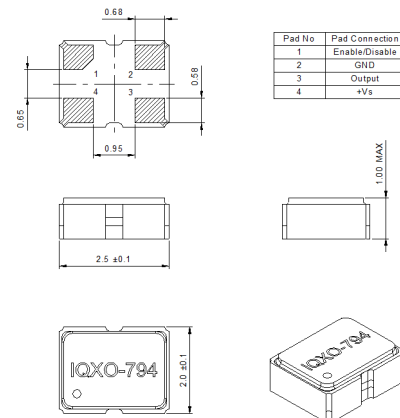

### Recommended Solder Pad Layout

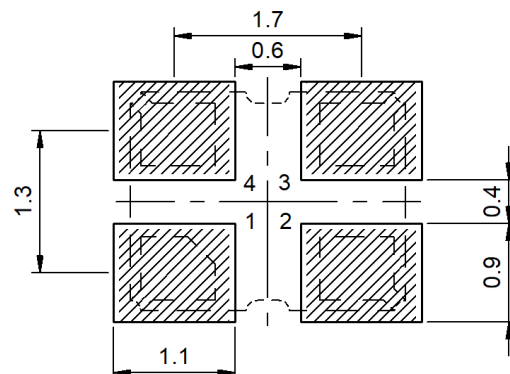

### CONTACT INFORMATION:

Würth Elektronik eiSos GmbH & Co. KG  
Max-Eyth-Str. 1, 74638 Waldenburg, Germany  
Tel: +49(0) 7942 945-0

Email: eiSos@we-online.de  
Web: www.we-online.com

### Manufacturing Details

- RoHS Terminations NiAu
- RoHS Reflow Temp 260°C max for 10 seconds max

### Compliance

- RoHS Status (2015/863/EU) Compliant
- REACH Status Compliant
- MSL Rating (JDEC-STD-033): Not Applicable

### Packaging Details

- Tape & reel in accordance with EIA-481  
Quantities below the standard reel size to  
be supplied on cut tape.  
Standard Quantity: 3,000 Pieces
- 

## USEFUL LINKS

#### Toolbox:

[www.we-online.com/toolbox](http://www.we-online.com/toolbox)

#### Product Catalog:

[www.we-online.com/products](http://www.we-online.com/products)

### CONTACT INFORMATION:

Würth Elektronik eiSos GmbH & Co. KG  
Max-Eyth-Str. 1, 74638 Waldenburg, Germany  
Tel: +49(0) 7942 945-0

Email: [eiSos@we-online.de](mailto:eiSos@we-online.de)  
Web: [www.we-online.com](http://www.we-online.com)