

Description

- Standard 2.5 x 2.0 oscillator in a ceramic package with a hermetically sealed metal lid.
- Model: IQXO-794
- Model Issue number: 4

Frequency Parameters

- Frequency: 4.0MHz
- Frequency Stability: ± 25.00 ppm
- Operating Temperature Range: -20.00 to 70.00°C
- Ageing: ± 5 ppm per year

Electrical Parameters

- Supply Voltage: 1.8V $\pm 10\%$
- Current Draw: 10.000mA max

Output Details

- Output Compatibility: CMOS
- Drive Capability: 15pF max
- Rise and Fall Time: 7.0ns max
- Duty Cycle: 40/60 max
- Start Up Time:
0.9ms typ to 90% of final amplitude (under ideal conditions @25°C)
10ms max
- Output Voltage Levels:
Output Low (VoL): 10% Vs max
Output High (VoH): 90% Vs min

Output Control

- Enable/Disable:
Logic '1' ($\geq 70\%$ Vs) to pad 1 enables oscillator output.
Logic '0' ($\leq 30\%$ Vs) to pad 1 disables oscillator output. When disabled the oscillator output goes to the high impedance state.
No connection to pad 1 enables oscillator output.
- Standby Current:
0.5 μ A typ @25°C
10 μ A max

Noise Parameters

- Period Jitter (pk-pk): ± 80 ps typ
- Period Jitter (1 σ): ± 10 ps typ
- RMS Phase Jitter (12kHz to 20MHz): 1ps max

Environmental Parameters

- Storage Temperature Range: -55 to 125°C
- Shock: Half Sine shock pulse with peak acceleration 500g; Pulse duration: 0.3ms
- Vibration: MIL-STD-202 Method 204. 5g for 20 minutes, 12 cycles in each of the 3 orientations, 10 ~ 2000 Hz. As per Table 11 of AEC-Q200.

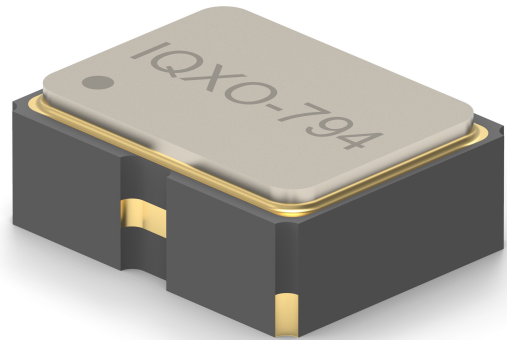

Outline (mm)

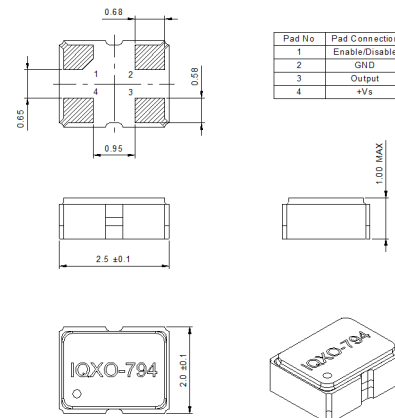

Recommended Solder Pad Layout

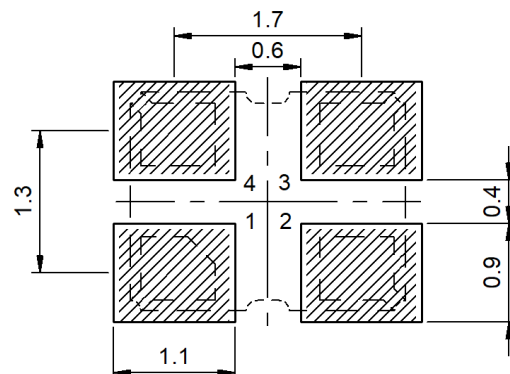

CONTACT INFORMATION:

Würth Elektronik eiSos GmbH & Co. KG
Max-Eyth-Str. 1, 74638 Waldenburg, Germany
Tel: +49(0) 7942 945-0

Email: eiSos@we-online.de
Web: www.we-online.com

Manufacturing Details

- RoHS Terminations NiAu
- RoHS Reflow Temp 260°C max for 10 seconds max

Compliance

- RoHS Status (2015/863/EU) Compliant
- REACH Status Compliant
- MSL Rating (JDEC-STD-033): Not Applicable

Packaging Details

- Tape & reel in accordance with EIA-481
Quantities below the standard reel size to
be supplied on cut tape.
Standard Quantity: 3,000 Pieces
-

USEFUL LINKS

Toolbox:

www.we-online.com/toolbox

Product Catalog:

www.we-online.com/products

CONTACT INFORMATION:

Würth Elektronik eiSos GmbH & Co. KG
Max-Eyth-Str. 1, 74638 Waldenburg, Germany
Tel: +49(0) 7942 945-0

Email: eiSos@we-online.de
Web: www.we-online.com