

### Description

- Standard 3.2 x 2.5mm SMD crystal in a ceramic package with a seam sealed metal lid, hermetically sealed.
- Model CFPX-180
- Model Issue number 13

### Frequency Parameters

- Frequency 26.00MHz
- Frequency Tolerance  $\pm 10.00$ ppm
- Tolerance Condition @25°C
- Frequency Stability  $\pm 20.00$ ppm
- Operating Temperature Range -40.00 to 105.00°C
- Overtone Order Fundamental
- Ageing  $\pm 5$ ppm max per year @25°C

### Electrical Parameters

- Load Capacitance (CL) 12.00pF
- Shunt Capacitance (C0) 7pF max
- Drive Level 100µW max
- ESR 50.00Ω max

### Environmental Parameters

- Storage Temperature Range: -55 to 125°C
- Shock: 1500g, 0.5ms, 3 times in each of the 3 mutually perpendicular planes.
- Vibration: MIL-STD-883F, 20g (20Hz~2000Hz), 1.52mm amplitude, 20 minutes in 3 mutually perpendicular planes, 4 cycles.

### Manufacturing Details

- RoHS Terminations NiAu
- RoHS Reflow Temp 260°C max over 10 seconds

### Compliance

- RoHS Status (2015/863/EU) Compliant
- REACH Status Compliant
- MSL Rating (JDEC-STD-033): Not Applicable

### Packaging Details

- Tape & reel in accordance with EIA-481  
Quantities below the standard reel size to be supplied on cut tape  
Standard Quantity: 3,000 Pieces

## USEFUL LINKS

#### Toolbox:

[www.we-online.com/toolbox](http://www.we-online.com/toolbox)

#### Product Catalog:

[www.we-online.com/products](http://www.we-online.com/products)



### Outline (mm)

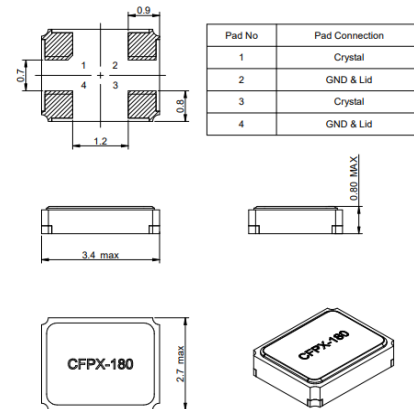

### Recommended Solder Pad Layout

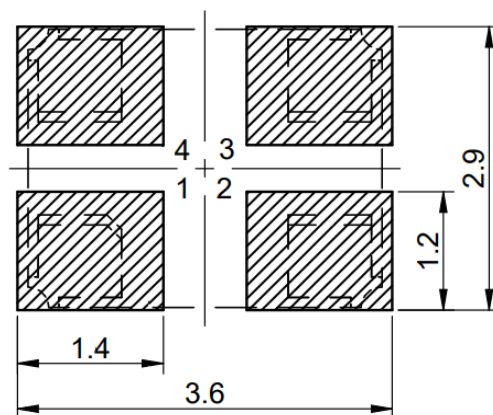

### CONTACT INFORMATION:

Würth Elektronik eiSos GmbH & Co. KG  
Max-Eyth-Str. 1, 74638 Waldenburg, Germany  
Tel: +49(0) 7942 945-0

Email: [eiSos@we-online.de](mailto:eiSos@we-online.de)  
Web: [www.we-online.com](http://www.we-online.com)