

Description

- 2 x 1.6mm SMD crystal
Ceramic package with a seam sealed metal lid, hermetically sealed
- Model IQXC-42
- Model Issue number 2

Frequency Parameters

- Frequency 38.40MHz
- Frequency Tolerance ± 10.00 ppm
- Frequency Stability ± 15.00 ppm
- Operating Temperature Range -40.00 to 85.00°C
- Overtone Order Fundamental
- Ageing ± 3 ppm per year

Electrical Parameters

- Load Capacitance (CL) 8.00pF
- Shunt Capacitance (C0) 3pF max
- Drive Level 100 μ W max
- ESR 100.00 Ω max

Environmental Parameters

- Storage Temperature Range: -55 to 125°C
- Vibration (MIL-STD-202 Method 204): Frequency: 10 - 55 Hz. Amplitude: 0.7 - 0.9 mm pk-pk. Sweep: 1 minute. Duration: 2 hours in each of 3 mutually perpendicular direction.
- Shock Test (MIL-STD-202 Method 213. Condition C): Half-sine shock pulse peak acceleration of 100g ; pulse duration of 6ms.

Compliance

- RoHS Status (2015/863/EU) Compliant
- REACH Status Compliant
- MSL Rating (JDEC-STD-033): Not Applicable

Packaging Details

- Tape & reel in accordance with EIA-481
Quantities below the standard reel size to be supplied on cut tape.
Standard Quantity: 3,000 Pieces

USEFUL LINKS

Toolbox:

www.we-online.com/toolbox

Product Catalog:

www.we-online.com/products



Outline (mm)

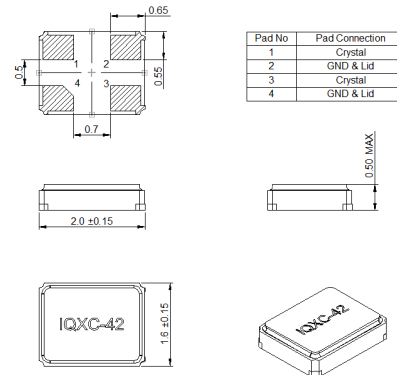

Note: The pad style on the base of the device may differ slightly from the drawing.
The chamfer may appear on pad 2 or 4.
This causes no change to the electrical performance of the device

Recommended solder pad layout

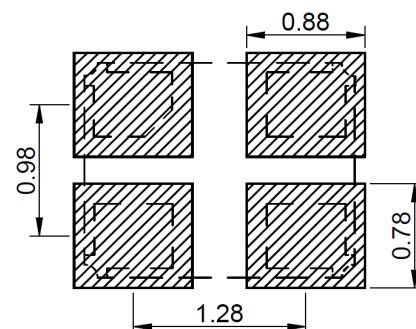

CONTACT INFORMATION:

Würth Elektronik eiSos GmbH & Co. KG
Max-Eyth-Str. 1, 74638 Waldenburg, Germany
Tel: +49(0) 7942 945-0

Email: eiSos@we-online.de
Web: www.we-online.com