

### Description

- 2 x 1.6mm SMD crystal  
Ceramic package with a seam sealed metal lid, hermetically sealed
- Model IQXC-42
- Model Issue number 2

### Frequency Parameters

- Frequency 32.0MHz
- Frequency Tolerance  $\pm 10.00\text{ppm}$
- Frequency Stability  $\pm 15.00\text{ppm}$
- Operating Temperature Range  $-40.00$  to  $85.00^\circ\text{C}$
- Overtone Order Fundamental
- Ageing  $\pm 3\text{ppm}$  per year

### Electrical Parameters

- Load Capacitance (CL) 8.00pF
- Shunt Capacitance (C0) 3pF max
- Drive Level 100 $\mu\text{W}$  max
- ESR 100.00 $\Omega$  max

### Environmental Parameters

- Storage Temperature Range:  $-55$  to  $125^\circ\text{C}$
- Vibration (MIL-STD-202 Method 204 ): Frequency: 10 - 55 Hz. Amplitude: 0.7 - 0.9 mm pk-pk. Sweep: 1 minute. Duration: 2 hours in each of 3 mutually perpendicular direction.
- Shock Test (MIL-STD-202 Method 213. Condition C): Half-sine shock pulse peak acceleration of 100g ; pulse duration of 6ms.

### Compliance

- RoHS Status (2015/863/EU) Compliant
- REACH Status Compliant
- MSL Rating (JDEC-STD-033): Not Applicable

### Packaging Details

- Tape & reel in accordance with EIA-481  
Quantities below the standard reel size to be supplied on cut tape.  
Standard Quantity: 3,000 Pieces

## USEFUL LINKS

#### Toolbox:

[www.we-online.com/toolbox](http://www.we-online.com/toolbox)

#### Product Catalog:

[www.we-online.com/products](http://www.we-online.com/products)



### Outline (mm)

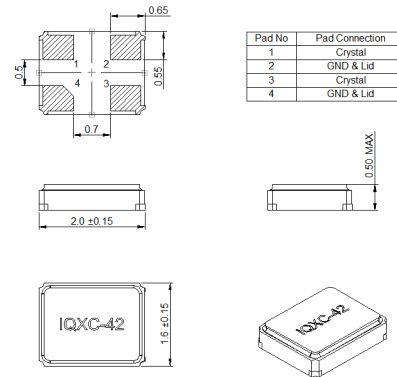

Note: The pad style on the base of the device may differ slightly from the drawing.  
The chamfer may appear on pad 2 or 4.  
This causes no change to the electrical performance of the device

### Recommended solder pad layout

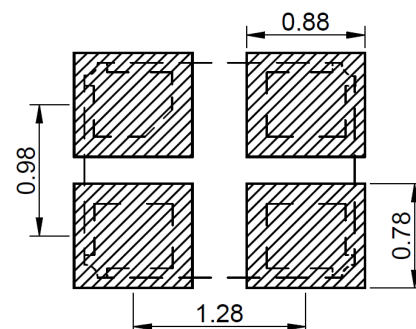

### CONTACT INFORMATION:

Würth Elektronik eiSos GmbH & Co. KG  
Max-Eyth-Str. 1, 74638 Waldenburg, Germany  
Tel: +49(0) 7942 945-0

Email: [eiSos@we-online.de](mailto:eiSos@we-online.de)  
Web: [www.we-online.com](http://www.we-online.com)