

Description

- Standard 3.2 x 2.5mm SMD crystal in a ceramic package with a seam sealed metal lid, hermetically sealed.
- Model CFPX-180
- Model Issue number 13

Frequency Parameters

- Frequency 24.0MHz
- Frequency Tolerance $\pm 10.00\text{ppm}$
- Tolerance Condition @25°C
- Frequency Stability $\pm 20.00\text{ppm}$
- Operating Temperature Range -40.00 to 85.00°C
- Overtone Order Fundamental
- Ageing $\pm 5\text{ppm max per year @25°C}$

Electrical Parameters

- Load Capacitance (CL) 8.00pF
- Shunt Capacitance (C0) 7pF max
- Drive Level 100µW max
- ESR 50.00Ω max

Environmental Parameters

- Storage Temperature Range: -55 to 125°C
- Shock: 1500g, 0.5ms, 3 times in each of the 3 mutually perpendicular planes.
- Vibration: MIL-STD-883F, 20g (20Hz~2000Hz), 1.52mm amplitude, 20 minutes in 3 mutually perpendicular planes, 4 cycles.

Manufacturing Details

- RoHS Terminations NiAu
- RoHS Reflow Temp 260°C max over 10 seconds

Compliance

- RoHS Status (2015/863/EU) Compliant
- REACH Status Compliant
- MSL Rating (JDEC-STD-033): Not Applicable

Packaging Details

- Tape & reel in accordance with EIA-481
Quantities below the standard reel size to be supplied on cut tape
Standard Quantity: 3,000 Pieces

USEFUL LINKS

Toolbox:

www.we-online.com/toolbox

Product Catalog:

www.we-online.com/products



Outline (mm)

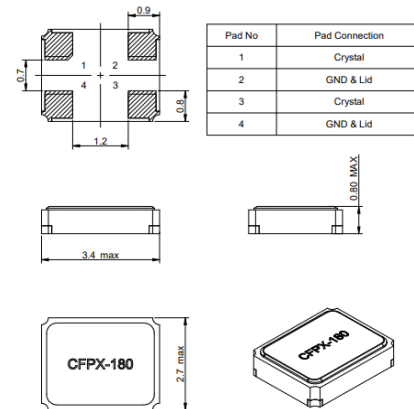

Recommended Solder Pad Layout

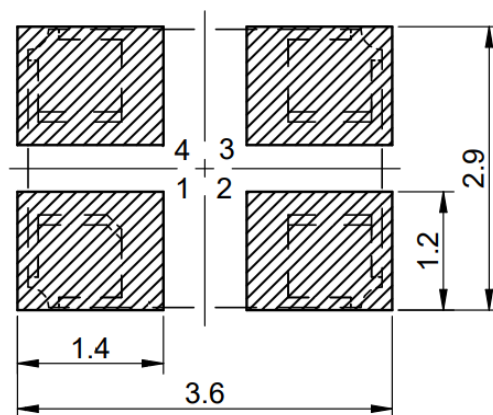

CONTACT INFORMATION:

Würth Elektronik eiSos GmbH & Co. KG
Max-Eyth-Str. 1, 74638 Waldenburg, Germany
Tel: +49(0) 7942 945-0

Email: eiSos@we-online.de
Web: www.we-online.com