

Description

- Standard 1.6 x 1.2mm SMD crystal in a hermetically sealed ceramic package with a sealed metal lid
- Model IQXC-26
- Model Issue number 5

Frequency Parameters

- Frequency 27.0MHz
- Frequency Tolerance $\pm 10.00\text{ppm}$
- Tolerance Condition @ 25°C
- Frequency Stability $\pm 20.00\text{ppm}$
- Operating Temperature Range -40.00 to 85.00°C
- Overtone Order Fundamental
- Ageing $\pm 3\text{ppm max per year @ 25°C}$

Electrical Parameters

- Load Capacitance (CL) 8.00pF
- Shunt Capacitance (C0) 3pF max
- Drive Level 100µW max
- ESR 150.00Ω max

Environmental Parameters

- Storage Temperature Range: -55 to 125°C
- Shock Test (MIL-STD-202 Method 213): Half Sine shock pulse with peak acceleration 500g. Pulse duration: 0.3ms.
- Vibration (MIL-STD-202 Method 204): Frequency: 10 - 55 Hz. Amplitude: 0.7 - 0.9 mm pk-pk. Sweep: 1 minute. Duration: 2 hours in each of 3 mutually perpendicular direction.

Compliance

- RoHS Status (2015/863/EU) Compliant
- REACH Status Compliant
- MSL Rating (JDEC-STD-033): Not Applicable

Packaging Details

- Tape & reel in accordance with EIA-481
- Quantities below the standard reel size to be supplied on cut tape.
- Standard Quantity: 3,000 Pieces

USEFUL LINKS

Toolbox:

www.we-online.com/toolbox

Product Catalog:

www.we-online.com/products



Outline (mm)

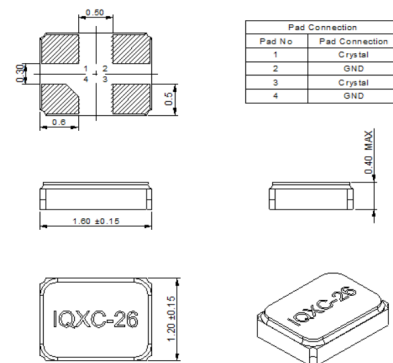

NOTE: The pad style on the base of the device may differ slightly from the drawing. The chamfer may appear on Pad 1 or 4. This causes no change to the electrical performance of the device.

Recommended Solder Pad Layout

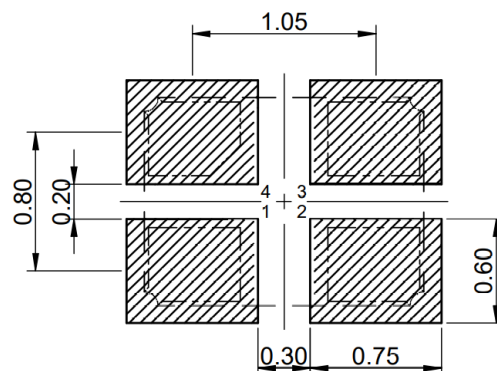

CONTACT INFORMATION:

Würth Elektronik eiSos GmbH & Co. KG
Max-Eyth-Str. 1, 74638 Waldenburg, Germany
Tel: +49(0) 7942 945-0

Email: eiSos@we-online.de
Web: www.we-online.com