

CUSTOMER TERMINAL	RoHS	LEAD(Pb)-FREE
Sn96%, Ag4%	Yes	Yes

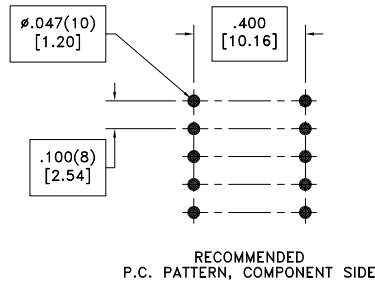

ELECTRICAL SPECIFICATIONS @ 25°C unless otherwise noted:

PARAMETER	TEST CONDITIONS	VALUE
D.C. RESISTANCE	1-2 @20°C	0.530 ohms ±10%
D.C. RESISTANCE	3-5 @20°C	2.05 ohms ±10%
D.C. RESISTANCE	7-9 @20°C	0.020 ohms max.
INDUCTANCE	3-5 10kHz, 100mVAC, Ls	1.50mH ±10%
SATURATION CURRENT	20% rolloff from initial	425mA
LEAKAGE INDUCTANCE	3-5 tie(1+2, 7+9), 100kHz, 100mVAC, Ls	20uH typ., 40uH max.
DIELECTRIC	1-9 tie(2+3), 4000VAC, 1 second	4000VAC, 1 minute
DIELECTRIC	1-5 625VAC, 1 second	500VAC, 1 minute
TURNS RATIO	(3-4):(4-5)	1.57:1, ±1%
TURNS RATIO	(3-5):(1-2)	4.91:1, ±1%
TURNS RATIO	(3-5):(9-7)	15.42:1, ±2%

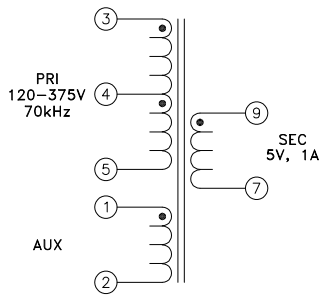
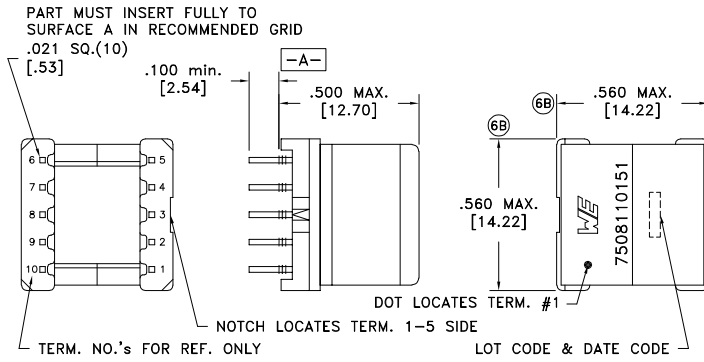

GENERAL SPECIFICATIONS:

OPERATING TEMPERATURE RANGE: -40°C to +125°C including temp rise.

Designed to comply with the following requirements as defined by IEC61558-2-16:
 - Reinforced insulation for a primary circuit at a working voltage of 220V.

Wire insulation & RoHS status not affected by wire color.
 Wire insulation color may vary depending on availability.

REV.	DATE	Packaging Specifications Method: Tray PKG-1292 www.we-online.com/midcom		Tolerances unless otherwise specified: Angles: ±1° Fractions: ±1/64 Decimals: ±.005 [1.3] Footprint: ±.001 [1.03]	DRAWING TITLE TRANSFORMER	PART NO. 7508110151
6B	8/22			This drawing is dual dimensioned. Dimensions in brackets are in millimeters.	eiSos p/n: 7508110151	
6A	11/13	SEE REVISION SHEET FOR REVISION LEVEL				SPECIFICATION SHEET 1 OF 1