

Partnumber	Color
714281050	black
714284050	grey
714286050	red
714287050	blue

TECHNICAL CHARACTERISTICS

MATERIAL

>Base: POM UL HB

MOUNTING INSTRUCTION

>Please mount the actuator that cut-out is in line with the positioning arrow of the rotary switch.

>For reflow soldering only to be fitted after the soldering process.

PACKAGING INFORMATION



>Bag

Scale - 2:1

This electronic component is designed and developed with the intention for use in general electronics equipments.

Before incorporating the components into any equipments in the field such as aerospace, aviation, nuclear control, submarine, transportation, (automotive control, train control, ship control), transportation signal, disaster prevention, medical, public information network etc. where higher safety and reliability are especially required or if there is possibility of direct damage or injury to human body, Würth Elektronik must be asked for a written approval.

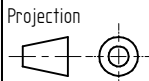
In addition, even electronic component in general electronic equipments, when used in electrical circuits that require high safety, reliability functions or performance, the sufficient reliability evaluation-check for the safety must be performed before by the user before usage.

		Projection 		GENERAL TOLERANCE		Basic material				
				.x = +/- 0,2 .xx = +/- 0,15						
				Date	Name	DESCRIPTION				
				Drawn	11-04-26	Jelisarow	AssSw			
				Checked			Plug-in actuator_for Rotary Switch Cross type			
						Scale	2:1	Position		SIZE
a	Mounting Instruction	11-12-19	WJ	 Würth Elektronik eiCan		Drawing.- No. 71428x050		A4		
REV	FILE	DATE	BY	EDV NO	71428x050.dft		System Solid Edge V20			