

1 2 3 4 5

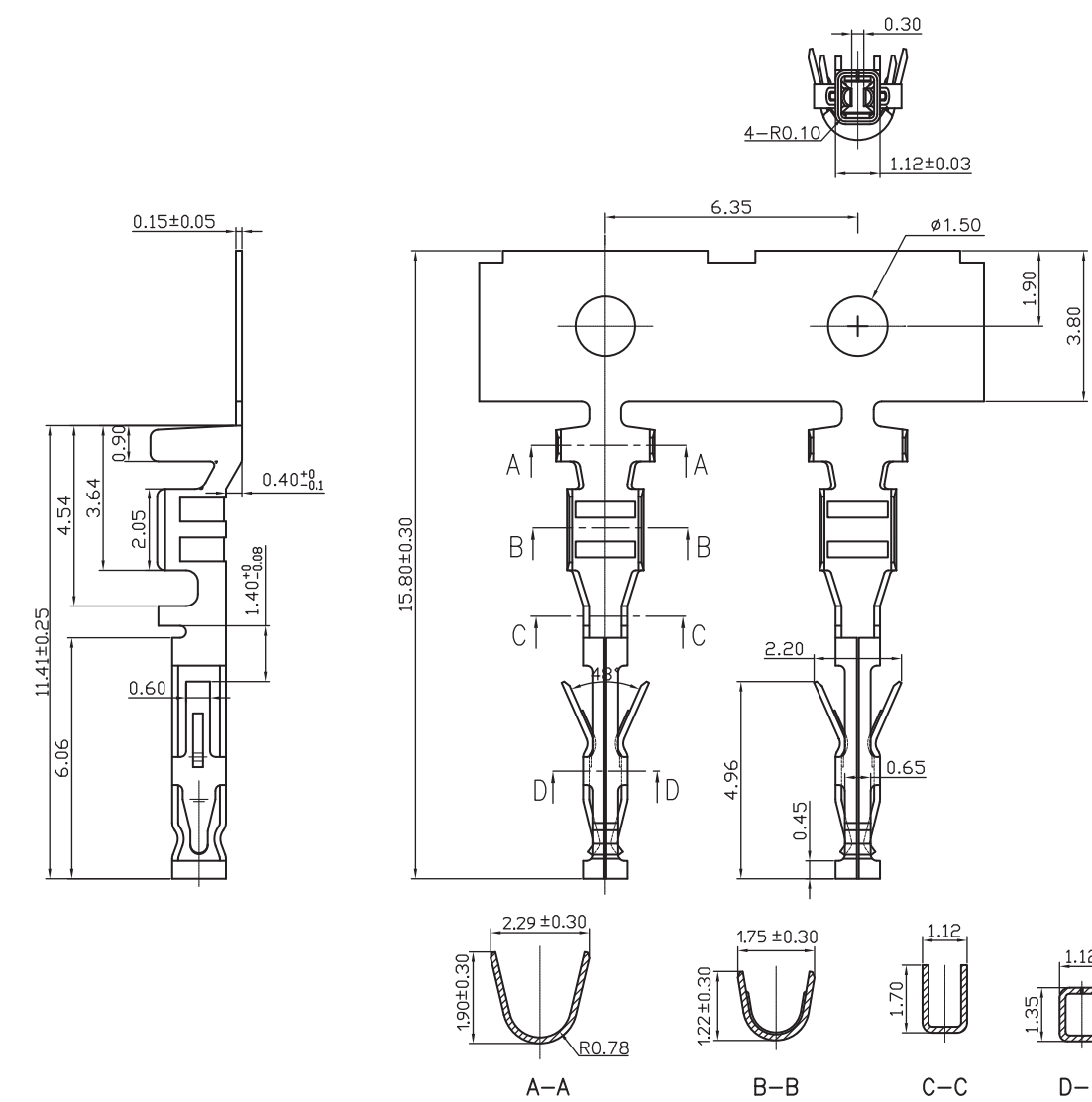

TECHNICAL CHARACTERISTICS

MATERIAL
 CONTACT MATERIAL: COPPER ALLOY
 CONTACT TYPE: STAMPED
 CONTACT PLATING: TIN
 QUALITY CLASS: 25 MATING CYCLES

ENVIRONMENTAL
 OPERATING TEMPERATURE: -25 UP TO 105 °C
 COMPLIANCE: LEAD FREE AND ROHS

ELECTRICAL
 CURRENT RATING: 5A
 WORKING VOLTAGE: 250 VAC
 CONTACT RESISTANCE: 10 mOHM MAX

MECHANICAL
 STRANDED WIRE: 30-26 AWG

PACKAGING
 REEL OF 10KPCS

A
B
C

RoHS Compliant			
F			
E			
D			
C			
B			
A	13-JUL-15	PDF	AK
REV	DATE	FILE	BY

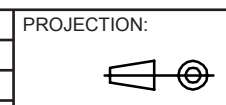

GENERAL TOLERANCE
 .X = +/- 0.2
 .XX = +/- 0.15



APPROVAL: BBU

UNIT: MM
 SCALE:
 SHEET: 1/2
 DRAW: AK

DESCRIPTION: 3.00 MM LOW FORCE FEMALE CRIMP TERMINAL
 WERI PART NO: 662 006 137 22

SIZE
A4

D

1

2

3

4

5

Cautions and Warnings:

This electronic component is designed and developed with the intention for use in general electronics equipments.

Before incorporating the components into any equipments in the field such as aerospace, aviation, nuclear control, submarine, transportation, (automotive control, train control, ship control), transportation signal, disaster prevention, medical, public information network etc. where higher safety and reliability are especially required or if there is possibility of direct damage or injury to human body, Würth Elektronik must be asked for a written approval.

In addition, even electronic component in general electronic equipments, when used in electrical circuits that require high safety, reliability functions or performance, the sufficient reliability evaluation-check for the safety must be performed before by the user before usage.

A

B

C

RoHS Compliant

G				PROJECTION: 	GENERAL TOLERANCE .X = +/- 0.2 .XX = +/- 0.15		
F							
E							
D							
C				APPROVAL: JC	UNIT: MM	DESCRIPTION: DISCLAIMER	SIZE A4
B					SCALE:		
A	10-SEP-14	PDF	QL		SHEET: 2/2	WERI PART NO: DISCLAIMER	
REV	DATE	FILE	BY		DRAW: QL		

D